

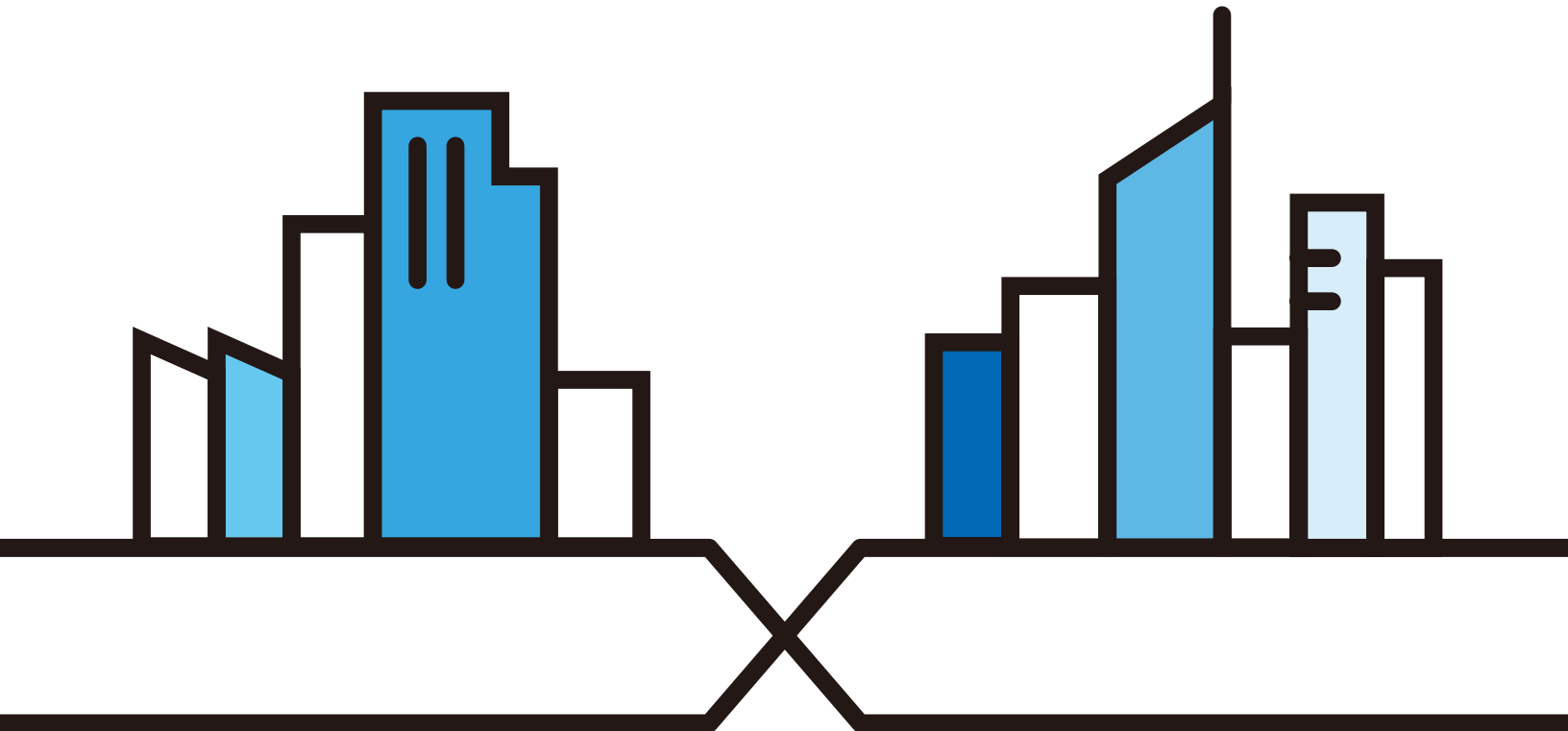
# User's Guide

## AX/DX/EX/PX Series

### Default Login Details

LAN IP Address	http://192.168.1.1
Login	admin
Password	See the device label

Version 5.15-5.70 Ed 10, 8/2023



---

**IMPORTANT!**

**READ CAREFULLY BEFORE USE.**

**KEEP THIS GUIDE FOR FUTURE REFERENCE.**

This is a User's Guide for a series of products. Not all products support all firmware features. Screenshots and graphics in this book may differ slightly from your product due to differences in product features or web configurator brand style. Every effort has been made to ensure that the information in this manual is accurate.

### **Related Documentation**

- Quick Start Guide

The Quick Start Guide shows how to connect the Zyxel Device.

- More Information

Go to <https://service-provider.zyxel.com/global/en/tech-support> to find other information on Zyxel Device.



# Document Conventions

## Warnings and Notes

These are how warnings and notes are shown in this guide.

**Warnings tell you about things that could harm you or your Zyxel Device.**









Note: Notes tell you other important information (for example, other things you may need to configure or helpful tips) or recommendations.

## Syntax Conventions

- Product labels, screen names, field labels and field choices are all in **bold** font.
- A right angle bracket ( > ) within a screen name denotes a mouse click. For example, **Network Setting > Routing > DNS Route** means you first click **Network Setting** in the navigation panel, then the **Routing** submenu, and then finally the **DNS Route** tab to get to that screen.

## Icons Used in Figures

Figures in this user guide may use the following generic icons. The Zyxel Device icon is not an exact representation of your Zyxel Device.

Zyxel Device 	Generic Router 	Switch 
Server 	Firewall 	USB Storage Device 
Printer 	4G LTE/5G NR Base Station 	

# Contents Overview

<b>User's Guide</b> .....	<b>18</b>
Introducing the Zyxel Device .....	19
Hardware .....	29
Web Configurator .....	65
Quick Start .....	77
Web Interface Tutorials .....	81
App Tutorials .....	130
<b>Technical Reference</b> .....	<b>185</b>
Connection Status .....	186
Broadband .....	199
Wireless .....	238
Home Networking .....	271
Routing .....	299
Quality of Service (QoS) .....	309
Network Address Translation (NAT) .....	331
DNS .....	350
IGMP/MLD .....	355
VLAN Group .....	358
Interface Grouping .....	361
USB Service .....	368
Firewall .....	374
MAC Filter .....	385
Home Security .....	388
Parental Control .....	390
Scheduler Rule .....	399
Certificates .....	401
Voice .....	411
Log .....	443
Traffic Status .....	446
VoIP Status .....	450
ARP Table .....	453
Routing Table .....	455
Multicast Status .....	458
xDSL Statistics .....	460
WLAN Station Status .....	463
Cellular Statistics .....	465
System .....	467

User Account .....	468
Remote Management .....	472
SNMP .....	476
Time Settings .....	479
Email Notification .....	482
Log Setting .....	485
Firmware Upgrade .....	489
Backup/Restore .....	492
Diagnostic .....	497
<b>Troubleshooting and Appendices .....</b>	<b>504</b>
Troubleshooting .....	505

# Table of Contents

<b>Document Conventions</b> .....	<b>3</b>
<b>Contents Overview</b> .....	<b>4</b>
<b>Table of Contents</b> .....	<b>6</b>
<b>Part I: User's Guide</b> .....	<b>18</b>
<b>Chapter 1</b>	
<b>Introducing the Zyxel Device</b> .....	<b>19</b>
1.1 Overview .....	19
1.2 Example Applications .....	22
1.2.1 WAN Priority .....	22
1.2.2 Dual-Band WiFi .....	23
1.2.3 Triple-Band WiFi .....	23
1.2.4 Multi-Gigabit Ethernet .....	24
1.2.5 VoIP Applications .....	25
1.2.6 Zyxel Device's USB Support .....	25
1.3 Ways to Manage the Zyxel Device .....	27
1.4 Good Habits for Managing the Zyxel Device .....	27
<b>Chapter 2</b>	
<b>Hardware</b> .....	<b>29</b>
2.1 Hardware .....	29
2.2 LED Indicators Panel .....	29
2.2.1 AX7501 .....	29
2.2.2 DX3300-T0, DX3301-T0, EX3300-T0 and EX3301-T0 .....	32
2.2.3 DX3300-T1 and EX3300-T1 .....	35
2.2.4 EX3500-T0 and EX3501-T0 .....	38
2.2.5 DX5401-B0/1 and EX5401-B0/1 .....	40
2.2.6 EX5600-T1, EX5601-T0 and EX5601-T1 .....	42
2.2.7 EX7501-B0 .....	45
2.2.8 PX3321-T1 .....	47
2.2.9 PX5311-T0 .....	48
2.3 Ports Panel .....	50
2.3.1 AX7501 .....	50
2.3.2 DX3300-T0, DX3301-T0, DX5401-B0/B1, EX3300-T0, EX3301-T0 and EX5401-B0/B1 .....	51
2.3.3 DX3300-T1 and EX3300-T1 .....	54

---

2.3.4 EX3500-T0 and EX3501-T0 .....	56
2.3.5 EX5600-T1, EX5601-T0, and EX5601-T1 .....	57
2.3.6 EX7501-B0 .....	60
2.3.7 PX3321-T1 .....	61
2.3.8 PX5531-T0 .....	61
2.3.9 Transceiver Installation/Removal .....	62
2.3.10 WPS Button .....	64
2.3.11 RESET Button .....	64
<b>Chapter 3</b>	
<b>Web Configurator.....</b>	<b>65</b>
3.1 Overview .....	65
3.1.1 Access the Web Configurator .....	65
3.2 Web Configurator Layout .....	67
3.2.1 Settings Icon .....	67
3.2.2 Widget Icon .....	74
<b>Chapter 4</b>	
<b>Quick Start.....</b>	<b>77</b>
4.1 Quick Start Overview .....	77
4.2 Quick Start Setup .....	77
4.3 Quick Start Setup – Time Zone .....	77
4.4 Quick Start Setup – Internet Connection .....	78
4.4.1 Successful Internet Connection .....	78
4.4.2 Unsuccessful Internet Connection .....	79
4.5 Quick Start Setup – WiFi .....	79
4.6 Quick Start Setup – Finish .....	80
<b>Chapter 5</b>	
<b>Web Interface Tutorials.....</b>	<b>81</b>
5.1 Web Interface Overview .....	81
5.2 Wired Network Setup .....	81
5.2.1 Setting Up a DSL Connection .....	81
5.2.2 Setting Up an Ethernet Connection .....	86
5.3 WiFi Network Setup .....	89
5.3.1 Changing Security on a WiFi Network .....	90
5.3.2 Connecting to the Zyxel Device's WiFi Network Using WPS .....	92
5.3.3 Setting Up a Guest Network .....	96
5.3.4 Setting Up Two Guest WiFi Networks on Different WiFi Bands .....	100
5.4 USB Applications .....	105
5.4.1 File Sharing .....	105
5.4.2 Media Server .....	108
5.4.3 Using FTP .....	113

---

5.5 Network Security .....	114
5.5.1 Configuring a Firewall Rule .....	114
5.5.2 Parental Control .....	116
5.5.3 Configuring a MAC Address Filter for Wired LAN Connections .....	121
5.6 Internet Calls .....	122
5.6.1 Configuring VoIP .....	122
5.6.2 Adding a SIP Service Provider .....	123
5.6.3 Adding a SIP Account .....	124
5.6.4 Configuring a Phone .....	125
5.6.5 Making a VoIP Call .....	126
5.7 Device Maintenance .....	126
5.7.1 Upgrading the Firmware .....	126
5.7.2 Backing up the Device Configuration .....	127
5.7.3 Restoring the Device Configuration .....	128
<b>Chapter 6</b>	
<b>App Tutorials.....</b>	<b>130</b>
6.1 App Tutorials Overview .....	130
6.2 What You Can Do .....	130
6.3 MPro Mesh Network .....	131
6.4 MPro Mesh Network Connection .....	134
6.4.1 Preparing your Zyxel Device .....	134
6.4.2 Setting up an MPro Mesh Router and MPro Mesh Extender with a WiFi or Wired Connection .....	135
6.4.3 Setting up a non-MPro Mesh Router and MPro Mesh Extender with a Wired Connection 142	
6.5 Finding the Best Location for the Extenders .....	150
6.6 Checking Your Network Topology .....	152
6.7 Changing the Default Home WiFi Network Name and Password .....	155
6.7.1 Letting WiFi Clients Connect to the WiFi Network .....	157
6.8 Blocking Internet Access at Specific Times .....	159
6.9 Seeing Currently Connected Client Devices .....	168
6.10 Changing the Client Device Names .....	170
6.11 Blocking Internet Access for Specific Clients Immediately .....	172
6.12 Setting Up the Guest WiFi Network .....	175
6.12.1 Letting WiFi Clients Only Connect to the Internet Through the Guest WiFi Network .	180
6.13 Viewing More App Information and the Online Help .....	182
6.13.1 Logging Out of the Controller Device .....	183
<b>Part II: Technical Reference.....</b>	<b>185</b>



<b>Chapter 7</b>	
<b>Connection Status</b> .....	<b>186</b>
7.1 Connection Status Overview .....	186
7.1.1 Connectivity .....	186
7.1.2 Icon and Device Name .....	188
7.1.3 System Info .....	188
7.1.4 WiFi Settings .....	191
7.2 Guest WiFi Settings .....	193
7.2.1 LAN .....	194
7.3 The Parental Control Screen .....	196
7.3.1 Create a Parental Control Profile .....	197
<b>Chapter 8</b>	
<b>Broadband</b> .....	<b>199</b>
8.1 Broadband Overview .....	199
8.1.1 What You Can Do in this Chapter .....	199
8.1.2 What You Need to Know .....	200
8.1.3 Before You Begin .....	203
8.2 Broadband Settings for DSL Routers .....	203
8.2.1 Add or Edit Internet Connection .....	204
8.3 Broadband Settings for Ethernet, AON and PON Routers .....	212
8.3.1 Add or Edit Internet Connection .....	214
8.4 Cellular Backup .....	221
8.5 Broadband Advanced Screen .....	227
8.6 Backup WAN .....	231
8.7 Technical Reference .....	232
<b>Chapter 9</b>	
<b>Wireless</b> .....	<b>238</b>
9.1 Wireless Overview .....	238
9.1.1 What You Can Do in this Chapter .....	238
9.1.2 What You Need to Know .....	238
9.2 Wireless General Settings .....	239
9.2.1 No Security .....	243
9.2.2 More Secure (Recommended) .....	243
9.3 Guest/More AP Screen .....	245
9.3.1 The Edit Guest/More AP Screen .....	246
9.4 MAC Authentication .....	249
9.5 WPS .....	250
9.6 WMM .....	252
9.7 Others Screen .....	254
9.8 Channel Status .....	256
9.9 MESH .....	258

---

9.9.1 MPro Mesh .....	258
9.10 Technical Reference .....	259
9.10.1 WiFi Network Overview .....	259
9.10.2 Additional WiFi Terms .....	261
9.10.3 WiFi Security Overview .....	261
9.10.4 Signal Problems .....	263
9.10.5 BSS .....	263
9.10.6 MBSSID .....	264
9.10.7 Preamble Type .....	264
9.10.8 WiFi Protected Setup (WPS) .....	265
<b>Chapter 10</b>	
<b>Home Networking.....</b>	<b>271</b>
10.1 Home Networking Overview .....	271
10.1.1 What You Can Do in this Chapter .....	271
10.1.2 What You Need To Know .....	271
10.1.3 Before You Begin .....	273
10.2 LAN Setup .....	273
10.3 Static DHCP .....	279
10.3.1 Before You Begin .....	279
10.4 UPnP .....	281
10.5 LAN Additional Subnet .....	282
10.6 STB Vendor ID .....	284
10.7 Wake on LAN .....	285
10.8 TFTP Server Name .....	285
10.9 APAS .....	286
10.9.1 Add APAS .....	288
10.10 Technical Reference .....	288
10.10.1 DHCP Setup .....	289
10.10.2 DNS Server Addresses .....	289
10.10.3 LAN TCP/IP .....	290
10.11 Turn on UPnP in Windows 10 Example .....	291
10.11.1 Auto-discover Your UPnP-enabled Network Device .....	293
10.12 Web Configurator Access with UPnP in Windows 10 .....	296
<b>Chapter 11</b>	
<b>Routing.....</b>	<b>299</b>
11.1 Routing Overview .....	299
11.2 Configure Static Route .....	299
11.2.1 Add or Edit Static Route .....	300
11.3 DNS Route .....	304
11.3.1 Add or Edit DNS Route .....	305
11.4 Policy Route .....	306

---

11.4.1 Add or Edit Policy Route .....	306
11.5 RIP Overview .....	308
11.5.1 RIP .....	308
<b>Chapter 12</b>	
<b>Quality of Service (QoS).....</b>	<b>309</b>
12.1 QoS Overview .....	309
12.1.1 What You Can Do in this Chapter .....	309
12.2 What You Need to Know .....	309
12.3 Quality of Service General Settings .....	311
12.4 Queue Setup .....	313
12.4.1 Add a QoS Queue .....	314
12.5 QoS Classification Setup .....	315
12.5.1 Add or Edit QoS Class .....	316
12.6 QoS Shaper Setup .....	321
12.6.1 Add or Edit a QoS Shaper .....	322
12.7 QoS Policer Setup .....	322
12.7.1 Add or Edit a QoS Policer .....	323
12.8 QoS Monitor .....	325
12.9 Technical Reference .....	326
<b>Chapter 13</b>	
<b>Network Address Translation (NAT).....</b>	<b>331</b>
13.1 NAT Overview .....	331
13.1.1 What You Can Do in this Chapter .....	331
13.1.2 What You Need To Know .....	331
13.2 Port Forwarding .....	332
13.2.1 Port Forwarding .....	333
13.2.2 Add or Edit Port Forwarding .....	333
13.3 Port Triggering .....	335
13.3.1 Add or Edit Port Triggering Rule .....	337
13.4 DMZ .....	338
13.5 ALG .....	339
13.6 Address Mapping .....	340
13.6.1 Address Mapping Screen .....	340
13.6.2 Add New Rule Screen .....	341
13.7 Sessions .....	343
13.8 Port Control Protocol (PCP) .....	343
13.8.1 Add New Rule Screen .....	345
13.9 Technical Reference .....	346
13.9.1 NAT Definitions .....	346
13.9.2 What NAT Does .....	347
13.9.3 How NAT Works .....	347

---

13.9.4 NAT Application .....	348
<b>Chapter 14</b>	
<b>DNS .....</b>	<b>350</b>
14.1 DNS Overview .....	350
14.1.1 What You Can Do in this Chapter .....	350
14.1.2 What You Need To Know .....	351
14.2 DNS Entry .....	351
14.2.1 Add or Edit DNS Entry .....	352
14.3 Dynamic DNS .....	352
<b>Chapter 15</b>	
<b>IGMP/MLD .....</b>	<b>355</b>
15.1 IGMP/MLD Overview .....	355
15.1.1 What You Need To Know .....	355
15.2 The IGMP/MLD Screen .....	355
<b>Chapter 16</b>	
<b>VLAN Group .....</b>	<b>358</b>
16.1 VLAN Group Overview .....	358
16.1.1 What You Can Do in this Chapter .....	358
16.2 VLAN Group Settings .....	359
16.2.1 Add or Edit a VLAN Group .....	359
<b>Chapter 17</b>	
<b>Interface Grouping .....</b>	<b>361</b>
17.1 Interface Grouping Overview .....	361
17.1.1 What You Can Do in this Chapter .....	361
17.2 Interface Grouping .....	361
17.2.1 Interface Group Configuration .....	362
17.2.2 Interface Grouping Criteria .....	366
<b>Chapter 18</b>	
<b>USB Service .....</b>	<b>368</b>
18.1 USB Service Overview .....	368
18.1.1 What You Can Do in this Chapter .....	368
18.1.2 What You Need To Know .....	368
18.1.3 Before You Begin .....	369
18.2 USB Service .....	369
18.2.1 Add New Share .....	371
18.2.2 Add New User Screen .....	372
18.3 Media Server .....	372

<b>Chapter 19</b>	
<b>Firewall</b> .....	<b>374</b>
19.1 Firewall Overview .....	374
19.1.1 What You Need to Know About Firewall .....	374
19.2 Firewall .....	375
19.2.1 What You Can Do in this Chapter .....	376
19.3 Firewall General Settings .....	376
19.4 Protocol (Customized Services) .....	377
19.4.1 Add Customized Service .....	378
19.5 Access Control (Rules) .....	378
19.5.1 Add New ACL Rule .....	379
19.6 DoS .....	381
19.7 Firewall Technical Reference .....	382
19.7.1 Firewall Rules Overview .....	382
19.7.2 Guidelines For Security Enhancement With Your Firewall .....	383
19.7.3 Security Considerations .....	384
<b>Chapter 20</b>	
<b>MAC Filter</b> .....	<b>385</b>
20.1 MAC Filter Overview .....	385
20.2 MAC Filter .....	385
20.2.1 Add New Rule .....	386
<b>Chapter 21</b>	
<b>Home Security</b> .....	<b>388</b>
21.1 Home Security Overview .....	388
21.2 Home Security .....	388
<b>Chapter 22</b>	
<b>Parental Control</b> .....	<b>390</b>
22.1 Parental Control Overview .....	390
22.2 Parental Control Schedule .....	390
22.2.1 Add or Edit a Parental Control Profile .....	391
22.2.2 Define a Schedule .....	392
22.2.3 Parental Control Scheduled Profile .....	392
22.3 Parental Control Schedule and URL Filter .....	393
22.3.1 Add or Edit a Parental Control Profile .....	395
<b>Chapter 23</b>	
<b>Scheduler Rule</b> .....	<b>399</b>
23.1 Scheduler Rule Overview .....	399
23.2 Scheduler Rule Settings .....	399
23.2.1 Add or Edit a Schedule Rule .....	400

---

<b>Chapter 24</b>	
<b>Certificates</b> .....	<b>401</b>
24.1 Certificates Overview .....	401
24.1.1 What You Can Do in this Chapter .....	401
24.2 What You Need to Know .....	401
24.3 Local Certificates .....	401
24.3.1 Create Certificate Request .....	403
24.3.2 View Certificate Request .....	404
24.4 Trusted CA .....	405
24.5 Import Trusted CA Certificate .....	406
24.6 View Trusted CA Certificate .....	407
24.7 Certificates Technical Reference .....	408
24.7.1 Verify a Certificate .....	409
<b>Chapter 25</b>	
<b>Voice</b> .....	<b>411</b>
25.1 Voice Overview .....	411
25.1.1 What You Can Do in this Chapter .....	411
25.1.2 What You Need to Know About VoIP .....	411
25.2 Before You Begin .....	412
25.3 SIP Account .....	412
25.3.1 Add or Edit SIP Account .....	413
25.4 SIP Service Provider .....	418
25.4.1 Provider Entry Add/Edit .....	419
25.5 SIP TLS Common .....	423
25.6 Phone .....	424
25.6.1 Phone Device .....	424
25.6.2 Phone Device Edit .....	425
25.7 Phone Region .....	426
25.8 Call Rule .....	427
25.9 Call History .....	428
25.10 Technical Reference .....	429
25.10.1 Quality of Service (QoS) .....	437
25.10.2 Phone Services Overview .....	438
<b>Chapter 26</b>	
<b>Log</b> .....	<b>443</b>
26.1 Log Overview .....	443
26.1.1 What You Can Do in this Chapter .....	443
26.1.2 What You Need To Know .....	443
26.2 System Log .....	444
26.3 Security Log .....	445

<b>Chapter 27</b>	
<b>Traffic Status</b> .....	<b>446</b>
27.1 Traffic Status Overview .....	446
27.1.1 What You Can Do in this Chapter .....	446
27.2 WAN Status .....	446
27.3 LAN Status .....	448
27.4 NAT Status .....	449
<b>Chapter 28</b>	
<b>VoIP Status</b> .....	<b>450</b>
28.1 VoIP Status Screen .....	450
<b>Chapter 29</b>	
<b>ARP Table</b> .....	<b>453</b>
29.1 ARP Table Overview .....	453
29.1.1 How ARP Works .....	453
29.2 ARP Table .....	453
<b>Chapter 30</b>	
<b>Routing Table</b> .....	<b>455</b>
30.1 Routing Table Overview .....	455
30.2 Routing Table .....	455
<b>Chapter 31</b>	
<b>Multicast Status</b> .....	<b>458</b>
31.1 Multicast Status Overview .....	458
31.2 The IGMP Status Screen .....	458
31.3 The MLD Status Screen .....	459
<b>Chapter 32</b>	
<b>xDSL Statistics</b> .....	<b>460</b>
32.1 xDSL Statistics Overview .....	460
32.2 xDSL Statistics .....	460
<b>Chapter 33</b>	
<b>WLAN Station Status</b> .....	<b>463</b>
33.1 WLAN Station Status Overview .....	463
<b>Chapter 34</b>	
<b>Cellular Statistics</b> .....	<b>465</b>
34.1 Cellular Statistics Overview .....	465
34.2 Cellular Statistics Settings .....	465

---

<b>Chapter 35</b>	
<b>System</b> .....	<b>467</b>
35.1 System Overview .....	467
35.2 System .....	467
<b>Chapter 36</b>	
<b>User Account</b> .....	<b>468</b>
36.1 User Account Overview .....	468
36.2 User Account .....	468
36.2.1 User Account Add or Edit .....	469
<b>Chapter 37</b>	
<b>Remote Management</b> .....	<b>472</b>
37.1 Remote Management Overview .....	472
37.1.1 What You Can Do in this Chapter .....	472
37.2 MGMT Services .....	472
37.3 Trust Domain .....	473
37.3.1 Add Trust Domain .....	474
<b>Chapter 38</b>	
<b>SNMP</b> .....	<b>476</b>
38.1 SNMP Overview .....	476
38.2 SNMP Settings .....	477
<b>Chapter 39</b>	
<b>Time Settings</b> .....	<b>479</b>
39.1 Time Settings Overview .....	479
39.2 Time .....	479
<b>Chapter 40</b>	
<b>Email Notification</b> .....	<b>482</b>
40.1 Email Notification Overview .....	482
40.2 Email Notification .....	482
40.2.1 E-mail Notification Edit .....	483
<b>Chapter 41</b>	
<b>Log Setting</b> .....	<b>485</b>
41.1 Log Setting Overview .....	485
41.2 Log Setting .....	485
41.2.1 Example Email Log .....	488
<b>Chapter 42</b>	
<b>Firmware Upgrade</b> .....	<b>489</b>



42.1 Firmware Upgrade Overview .....	489
42.2 Firmware Upgrade .....	489
<b>Chapter 43</b>	
<b>Backup/Restore .....</b>	<b>492</b>
43.1 Backup/Restore Overview .....	492
43.2 Backup/Restore .....	492
43.3 Reboot .....	496
<b>Chapter 44</b>	
<b>Diagnostic.....</b>	<b>497</b>
44.1 Diagnostic Overview .....	497
44.1.1 What You Can Do in this Chapter .....	497
44.2 What You Need to Know .....	497
44.3 Diagnostic .....	498
44.4 802.1ag (CFM) .....	499
44.5 802.3ah (OAM) .....	500
44.6 OAM Ping .....	501
<b>Part III: Troubleshooting and Appendices.....</b>	<b>504</b>
<b>Chapter 45</b>	
<b>Troubleshooting.....</b>	<b>505</b>
45.1 Troubleshooting Overview .....	505
45.2 Power and Hardware Problems .....	505
45.3 Device Access Problems .....	506
45.4 Internet Problems .....	509
45.5 WiFi Problems .....	511
45.6 USB Problems .....	512
45.7 VoIP Problems .....	512
45.8 UPnP Problems .....	513
45.9 Getting More Troubleshooting Help .....	513
Appendix A Customer Support .....	514
Appendix B Wireless LANs.....	519
Appendix C IPv6.....	532
Appendix D Services.....	538
Appendix E Legal Information .....	542
.....	<b>549</b>

---

# PART I

## User's Guide

---

# CHAPTER 1

## Introducing the Zyxel Device

### 1.1 Overview

The Zyxel Device refers to the models listed in the tables.

The AX Series are AON (Active Optical Network) routers while the PX Series are PON (Passive Optical Network) routers that connect through the Internet through a fiber cable.

The DX Series are DSL routers, which provide Internet access over telephone lines.

The EX Series are Ethernet gateways/routers that provide Internet access through the Ethernet WAN port or an SFP port.

The following table describes the feature differences of the Zyxel Device by model.

Table 1 Zyxel Device Comparison Table

	AX7501-B0	AX7501-B1	DX3300-T0	DX3300-T1	DX3301-T0	DX5401-B0	DX5401-B1
WiFi6 Wireless Standard	YES	YES	YES	YES	YES	YES	YES
Supported Frequency Bands	2.4 GHz 5 GHz	2.4 GHz 5 GHz	2.4 GHz 5 GHz	2.4 GHz 5 GHz	2.4 GHz 5 GHz	2.4 GHz 5 GHz	2.4 GHz 5 GHz
Port Control Protocol	YES	YES	YES	YES	YES	YES	YES
Advanced Broadband	NO	NO	NO	NO	YES	NO	NO
Parental Control Schedule	YES	YES	YES	YES	YES	YES	YES
Parental Control URL Filter	YES	YES	NO	NO	NO	NO	NO
Home Security URL filter	NO	NO	NO	YES	NO	NO	NO
FTP	YES	YES	YES	YES	YES	YES	YES
Telnet	YES	YES	YES	YES	YES	YES	YES
MPro Mesh Extender Support	YES	YES	YES	YES	YES	YES	YES
Multi-Gig WAN/LAN	10 Gbe LAN	10 Gbe LAN	NO	NO	NO	NO	NO
Backup WAN	NO	NO	NO	YES	NO	NO	NO

Table 1 Zyxel Device Comparison Table (continued)

	<b>AX7501-B0</b>	<b>AX7501-B1</b>	<b>DX3300-T0</b>	<b>DX3300-T1</b>	<b>DX3301-T0</b>	<b>DX5401-B0</b>	<b>DX5401-B1</b>
Uplink Port	1G Ethernet (SFP) 10G AON (SFP) 10G Ethernet (SFP) 10G XGPON (SFP+)	1G Ethernet (SFP) 10G AON (SFP) 10G Ethernet (SFP) 10G XGPON (SFP+)	DSL	DSL	DSL	DSL 1G Ethernet (SFP)	DSL 1G Ethernet (SFP)
USB Port for Cellular Backup, File Sharing and Media Server	USB 3.0	USB 3.0	USB 2.0	USB 2.0	USB 2.0	USB 3.0	USB 3.0
Phone Port (VoIP)	YES	YES	NO	NO	YES	YES	YES
Wall Mount	YES	YES	YES	NO	YES	YES	YES

Table 2 Zyxel Device Comparison Table

	<b>EX3300-T0</b>	<b>EX3300-T1</b>	<b>EX3301-T0</b>	<b>EX3500-T0</b>	<b>EX3501-T0</b>	<b>EX5401-B0</b>	<b>EX5401-B1</b>
WiFi6 Wireless Standard	YES	YES	YES	YES	YES	YES	YES
Supported Frequency Bands	2.4 GHz 5 GHz	2.4 GHz 5 GHz	2.4 GHz 5 GHz	2.4 GHz 5 GHz	2.4 GHz 5 GHz	2.4 GHz 5 GHz	2.4 GHz 5 GHz
Port Control Protocol	YES	YES	YES	YES	YES	YES	YES
Advanced Broadband	NO	NO	NO	NO	NO	NO	NO
Parental Control Schedule	YES	YES	YES	YES	YES	YES	YES
Parental Control URL Filter	NO	NO	NO	NO	NO	NO	NO
Home Security URL filter	NO	YES	NO	YES	YES	NO	NO
FTP	YES	YES	YES	YES	YES	YES	YES
Telnet	YES	YES	YES	YES	YES	YES	YES
MPro Mesh Extender Support	YES	YES	YES	YES	YES	YES	YES
Multi-Gig WAN/LAN	NO	NO	NO	NO	NO	NO	NO
Backup WAN	NO	YES	NO	NO	NO	NO	NO
Uplink Port	Ethernet	Ethernet	Ethernet	Ethernet	Ethernet	Ethernet 1G PON (SFP)	Ethernet 1G PON (SFP)
USB Port for Cellular Backup, File Sharing and Media Server	USB 2.0	USB 2.0	USB 2.0	USB 2.0	USB 2.0	USB 3.0	USB 3.0

Table 2 Zyxel Device Comparison Table (continued)

	EX3300-T0	EX3300-T1	EX3301-T0	EX3500-T0	EX3501-T0	EX5401-B0	EX5401-B1
Phone Port (VoIP)	NO	NO	YES	NO	YES	YES	YES
Wall Mount	YES	YES	YES	NO	NO	YES	YES

Table 3 Zyxel Device Comparison Table

	EX5600-T1	EX5601-T0	EX5601-T1	EX7501-B0	PX3321-T1	PX5311-T0
WiFi6 Wireless Standard	YES	YES	YES	YES	YES	YES
Supported Frequency Bands	2.4 GHz 5 GHz	2.4 GHz 5 GHz	2.4 GHz 5 GHz	2.4 GHz 5 GHz	2.4 GHz 5 GHz	2.4 GHz 5 GHz
Port Control Protocol	YES	YES	YES	YES	YES	YES
Advanced Broadband	NO	NO	NO	NO	NO	NO
Parental Control Schedule	YES	YES	YES	YES	YES	YES
Parental Control URL Filter	NO	NO	NO	NO	NO	NO
Home Security URL filter	YES	YES	YES	YES	NO	NO
FTP	YES	YES	YES	NO	YES	YES
Telnet	YES	YES	YES	NO	YES	YES
MPro Mesh Extender Support	YES	YES	YES	YES	YES	YES
Multi-Gig WAN/LAN	2.5 Gbe WAN 2.5 Gbe LAN	2.5 Gbe WAN 2.5 Gbe LAN	2.5 Gbe WAN 2.5 Gbe LAN	10 Gbe WAN 10 Gbe LAN	NO	NO
Backup WAN	NO	NO	NO	NO	NO	NO
Uplink Port	Ethernet	Ethernet 1G Ethernet (SFP) 2.5G GPON (SFP)	Ethernet	Ethernet	2.5G PON (SC-APC)	2.5G PON (SC-APC)
USB Port for Cellular Backup, File Sharing and Media Server	USB 3.0	USB 3.0	USB 3.0	USB 3.0	USB 2.0	USB 2.0
Phone Port (VoIP)	NO	YES	YES	YES	YES	YES
Wall Mount	YES	YES	YES	YES	YES	YES

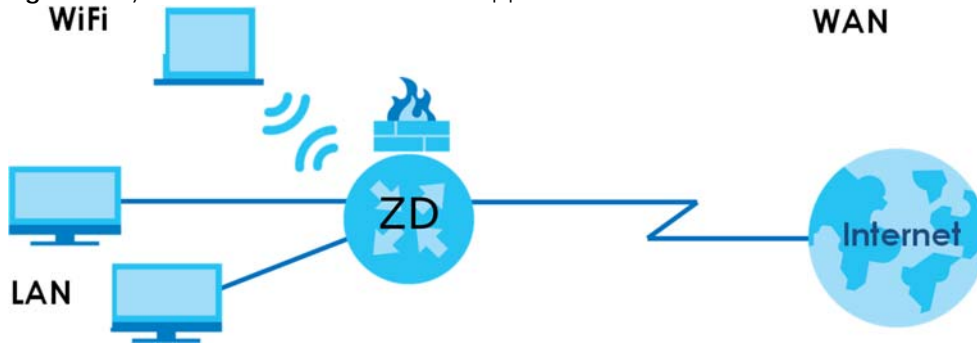
For DX3300/3301-T0 and EX3300/3301-T0, IGMP/MLD are enabled by default and are not configurable. The default IGMP version is 3. The default MLD version is 2.

## 1.2 Example Applications

This section shows a few examples of using the Zyxel Device in various network environments. Note that the Zyxel Device in the figure is just an example Zyxel Device and not your actual Zyxel Device.

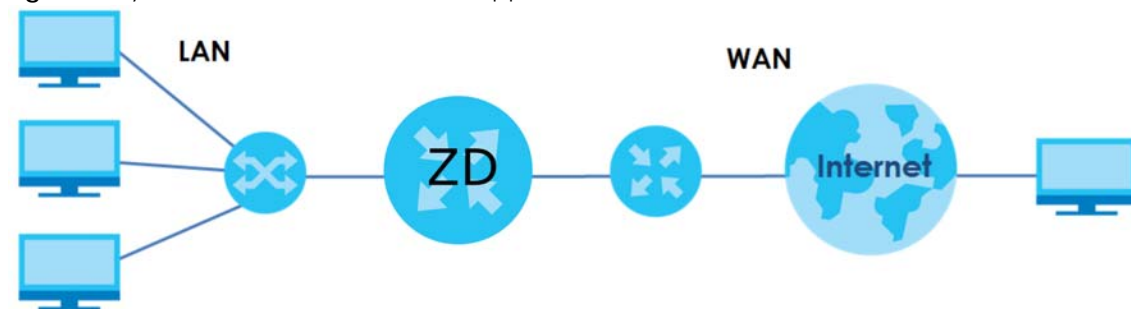
Connect the WAN port to a broadband modem or router for Internet connection. Connect computers to the Zyxel Device's LAN ports, or wirelessly, and access the Internet simultaneously.

**Figure 1** Zyxel Device's Internet Access Application



You can also configure Firewall on the Zyxel Device for secure Internet access. When the Firewall is on, all incoming traffic from the Internet to your network is blocked by default unless it is initiated from your network. This means that probes from the outside to your network are not allowed, but you can safely browse the Internet and download files.

**Figure 2** Zyxel Device's Internet Access Application: Ethernet WAN



### 1.2.1 WAN Priority

The WAN connection priority is as follows:

- 1 SFP
  - 2 Ethernet WAN
  - 3 DSL
  - 4 Cellular WAN (3G/4G)
- See [Section 1.2.6 on page 25](#) for more information about Cellular backup.

## 1.2.2 Dual-Band WiFi

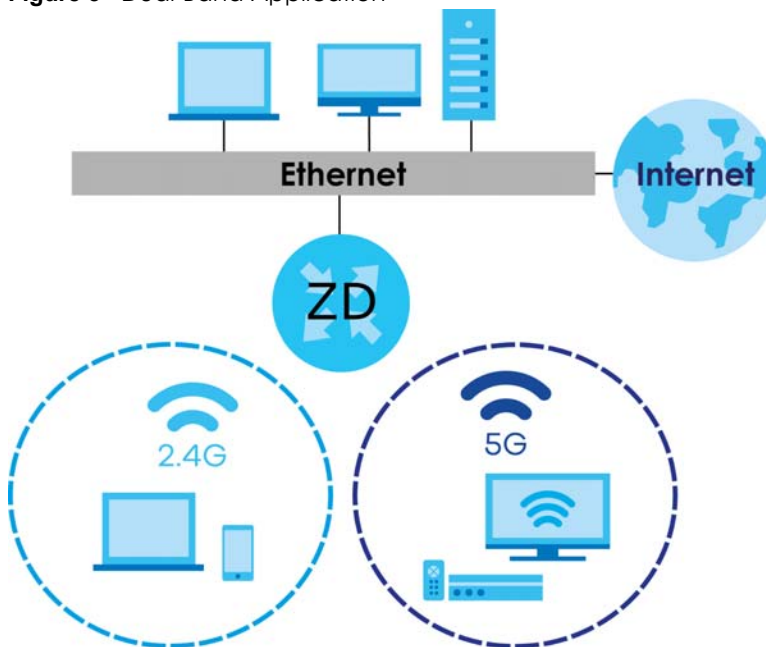
Note: Check [Section Table 1 on page 19](#) to see if your Zyxel Device supports dual-band WiFi.

When WiFi is enabled on the Zyxel Device, IEEE 802.11 a/b/g/n/ac/ax compliant clients, such as notebooks, tablets, and smartphones can wirelessly connect to the Zyxel Device to access network resources.

With dual-band, the Zyxel Device is a gateway that can use both 2.4G and 5G WiFi networks at the same time. WiFi clients could use the 2.4 GHz band for regular Internet surfing and downloading while using the 5 GHz band for time sensitive traffic like high-definition video, music, and gaming.

The Zyxel Device supports WiFi6 that is most suitable in areas with a high concentration of users.

**Figure 3** Dual-Band Application



## 1.2.3 Triple-Band WiFi

Note: Check [Section Table 1 on page 19](#) to see if your Zyxel Device supports triple-band WiFi.

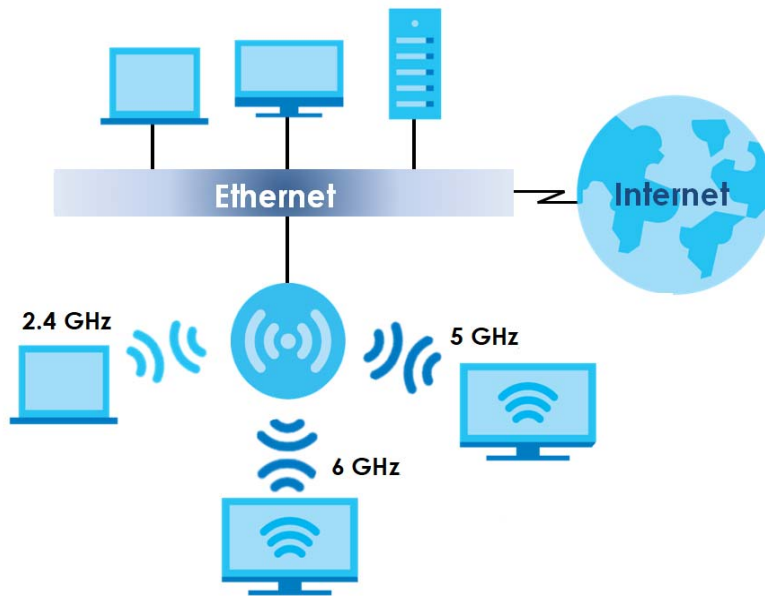
With triple-band, the Zyxel Device can use 2.4G/5G/6G bands to operate simultaneously.

The 6 GHz band provides less coverage but has the highest amount of channels among the three frequency bands. Use the 6 GHz band for the most congestion-free transmission if your client devices supports WiFi 6E.

Note: Due to each country's regulations on frequency band usage, the available bands (2.4 GHz, 5 GHz, and 6 GHz) may differ by countries or markets the Zyxel Device products are sold to.

WiFi clients could use the 2.4 GHz band for regular Internet surfing and downloading while using the 5 GHz or 6 GHz band for time sensitive traffic like high-definition video, music, and gaming.

Figure 4 Triple-Band Application



## 1.2.4 Multi-Gigabit Ethernet

For Zyxel Devices that support 10 Gbps/2.5 Gbps Multi-Gigabit Ethernet (GbE) WAN/LAN ports, the port speeds are backward compatible with standard Gigabit speed. The Zyxel Devices with an SFP port can also provide Internet access through a Multi-Gigabit GPON WAN or Ethernet connection.

A 2.5 Gigabit Ethernet port supports speeds of 2.5 Gbps if the connected device supports 2.5 Gbps. While a 10 Gigabit Ethernet port supports speeds of 10 Gbps if the connected device supports 10 Gbps and a Cat 6a (up to 100 m) or Cat 6 cable (up to 50 m) is used.

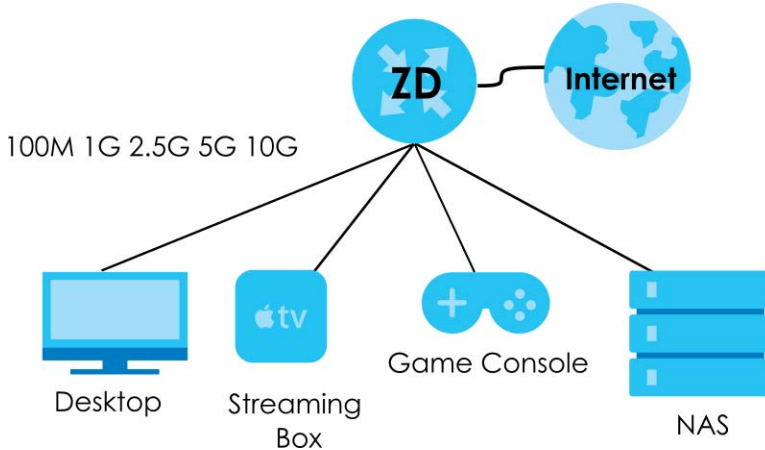
Some network devices such as gaming computers, servers, network attached storage (NAS) devices, or access points may have network cards that are capable of 2.5 Gbps or 5 Gbps connectivity.

If these devices are connected to a 1 Gbps or 10 Gbps Ethernet port, they can only transmit or receive up to 1 Gbps as speeds of 2.5 Gbps / 10 Gbps cannot be attained. Moreover, if network devices with 2.5 Gbps / 10 Gbps network cards are connected to a 2.5 Gbps / 10 Gbps Ethernet port, you must use Cat 5e / Cat 6A or better Ethernet cables to achieve 2.5 Gbps / 10 Gbps speeds. Most buildings, at the time of writing, use Cat 5e or Cat 6 Ethernet cables.

Multi-Gigabit Ethernet ports automatically allow connections up to the speed of the connected network device (100 Mbps (not supported on EX5501-B0), 1 Gbps, 2.5 Gbps or 5 Gbps), and you just need to use a Cat 5, Cat 5e or Cat 6 Ethernet cable.



**Figure 5** Multi-Gigabit Application



See the following table for the cables required and distance limitation to attain the corresponding speed.

**Table 4** Ethernet Cable Types

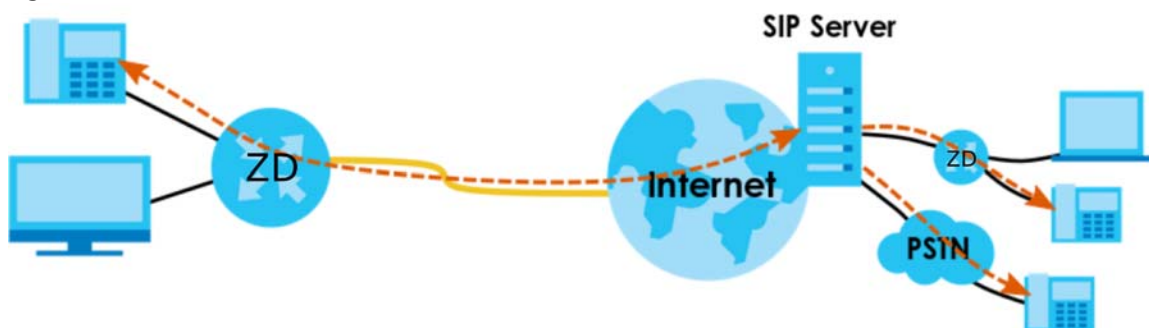
CABLE	TRANSMISSION SPEED	MAXIMUM DISTANCE	BANDWIDTH CAPACITY
Category 5	100 Mbps	100 m	100 MHz
Category 5e	1 Gbps / 2.5 Gbps / 5 Gbps	100 m	100 MHz
Category 6	5 Gbps / 10 Gbps	100m / 50 m	250 MHz
Category 6a	10 Gbps	100 m	500 MHz
Category 7	10 Gbps	100 m	650 MHz

\* A high quality Category 5e cable can support 5 Gbps and up to 100m with no electromagnetic interference.

## 1.2.5 VoIP Applications

The Zyxel Device's VoIP function allows you to register up to two SIP (Session Initiation Protocol) accounts and use the Zyxel Device to make and receive VoIP telephone calls. The Zyxel Device sends your call to a VoIP service provider's SIP server which forwards the calls to either VoIP or PSTN phones.

**Figure 6** VoIP Application



## 1.2.6 Zyxel Device's USB Support

The USB port of the Zyxel Device is used for cellular WAN backup, file-sharing, and media server.

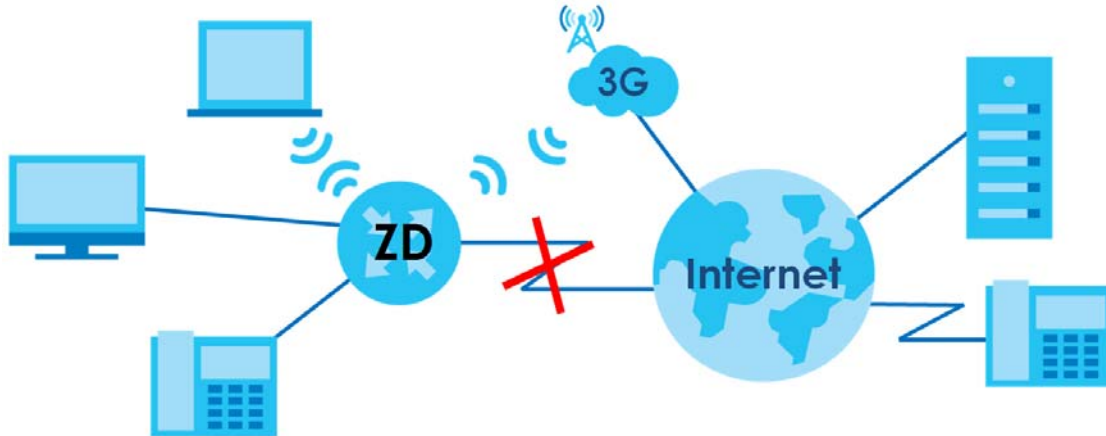
## Cellular WAN (3G/4G) Backup

Connect a supported cellular USB dongle with an active SIM card to the USB port. This adds a second WAN interface and allows the Zyxel Device to wirelessly access the Internet via a cellular network. The cellular WAN connection is a backup in case the DSL/Ethernet/Fiber connection fails.

To set up a cellular connection, click **Network > Broadband > Cellular Backup**.

To update the supported cellular USB dongle list, download the latest WWAN package from the Zyxel website and upload it to the Zyxel Device using the **Maintenance > Firmware Upgrade** screen.

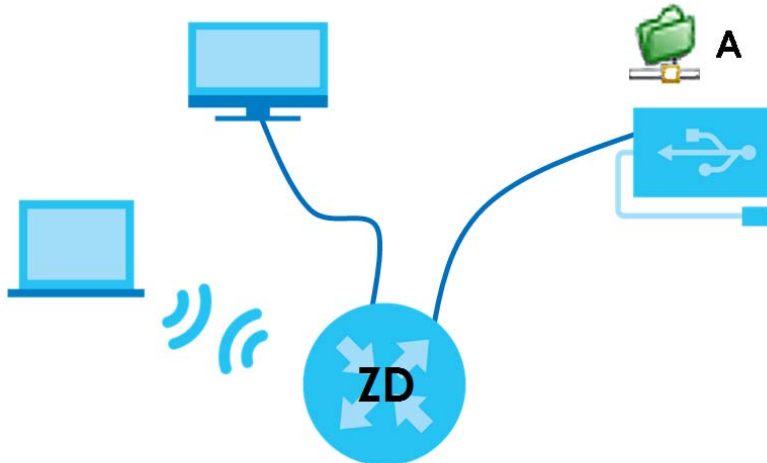
**Figure 7** Internet Access Application: Cellular WAN



## File Sharing

Use the built-in USB 3.0 port to share files on a USB memory stick or a USB hard drive (A). Use FTP to access the files on the USB device.

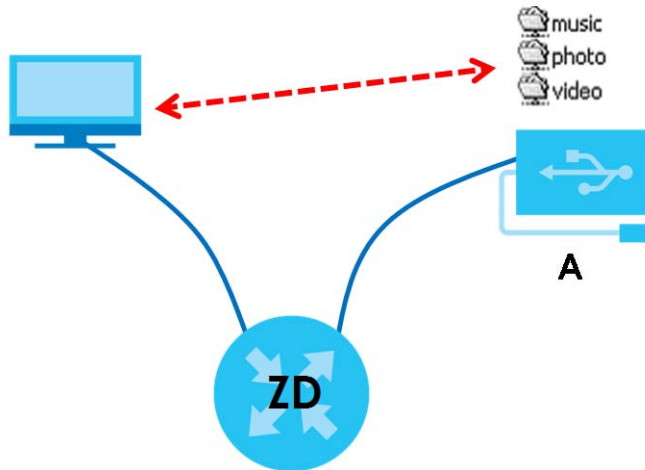
**Figure 8** USB File Sharing Application



## Media Server

You can also use the Zyxel Device as a media server. This lets anyone on your network play video, music, and photos from a USB device (A) connected to the Zyxel Device's USB port (without having to copy them to another computer).

**Figure 9** USB Media Server Application



## 1.3 Ways to Manage the Zyxel Device

Use any of the following methods to manage the Zyxel Device.

- Web Configurator. This is recommended for management of the Zyxel Device using a (supported) web browser.
- Simple Network Management Protocol (SNMP). Use to monitor and/or manage the Zyxel Device by an SNMP manager.
- Secure Shell (SSH), Telnet. Use for troubleshooting the Zyxel Device by qualified personnel.
- FTP. Use FTP for firmware upgrades and configuration backup or restore.

## 1.4 Good Habits for Managing the Zyxel Device

Do the following things regularly to make the Zyxel Device more secure and to manage the Zyxel Device more effectively.

- Change the WiFi and Web Configurator passwords. Use a password that is not easy to guess and that consists of different types of characters, such as numbers and letters.
- Write down the passwords and put it in a safe place.

- Back up the configuration (and make sure you know how to restore it). Restoring an earlier working configuration may be useful if the device becomes unstable or even crashes. If you forget your password, you will have to reset the Zyxel Device to its factory default settings. If you backed up an earlier configuration file, you would not have to totally re-configure the Zyxel Device. You could simply restore your last configuration.

# CHAPTER 2

## Hardware

### 2.1 Hardware

This section describes the front and rear panels for each model. If your model is not shown here, refer to the Zyxel Device's Quick Start Guides to see the product drawings and how to make the hardware connections.

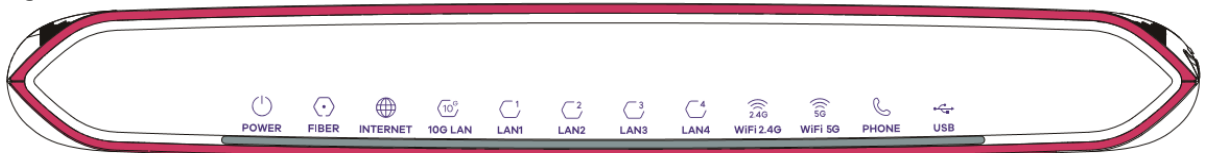
### 2.2 LED Indicators Panel

The following shows the Zyxel Device LED indicators panel and the LED behaviors.

None of the LEDs are on if the Zyxel Device is not receiving power.

#### 2.2.1 AX7501

Figure 10 LED Indicators (AX7501-B0 / AX7501-B1)



Note: The 2.5G LAN and 2.5G WAN LEDs are only for the Ethernet router. 10G LAN is only for the AON and PON routers. See [Section 1.1 on page 19](#) for more information.

The following are the LED descriptions for your AX7501.

Table 5 LED Descriptions (AX7501)

LED	COLOR	STATUS	DESCRIPTION
POWER	Green	On	The Zyxel Device is receiving power and ready for use.
		Blinking	The Zyxel Device is self-testing.
	Red	On	The Zyxel Device detected an error while self-testing, or there is a device malfunction.
		Blinking	The Zyxel Device is upgrading firmware.
	Off	The Zyxel Device is not receiving power.	
2.5G WAN	Blue	On	The Zyxel Device has a successful 2.5 Gbps Ethernet connection on the WAN.
	Green	On	The Zyxel Device has a successful 1 Gbps Ethernet connection on the WAN.
		Off	The Zyxel Device does not have an Ethernet connection with the WAN.
			The LED will cycle Green > Blue > Off > repeat, when the Zyxel Device has an unsupported 100 Mbps Ethernet connection on the WAN.

Table 5 LED Descriptions (AX7501) (continued)

LED	COLOR	STATUS	DESCRIPTION
FIBER	Green	On	The FIBER port is connected to the ISP's ONT and the Zyxel Device is receiving optical signals normally.
		Blinking	The Zyxel Device's FIBER port is trying to build a PON connection.
	Red	On	The optical power received (the strength of optical signals transmitted on the remote optical module) is too low.
		Off	The connection to the ISP's ONT is down.
INTERNET	Green	On	The Zyxel Device has an IP connection but no traffic.  Your device has a WAN IP address (either static or assigned by a DHCP server), PPP negotiation was successfully completed (if used).
		Blinking	The Zyxel Device is sending or receiving IP traffic.  Note: For AON and PON routers only; see <a href="#">Section 1.1 on page 19</a> for more information.
		Off	There is no Internet connection or the gateway is in Bridge mode.
	Red	On	The Zyxel Device attempted to make an IP connection but failed. Possible causes are no response from a DHCP server, no PPPoE response, PPPoE authentication failed.
		Blinking	The Zyxel Device has an unsupported 100 Mbps Ethernet connection on the WAN.  Note: For Ethernet routers only, see <a href="#">Section 1.1 on page 19</a> for more information.
		Off	
10G LAN (for AX7501-B0/AX7501-B1)	Green	On	The Zyxel Device has a successful 10/100/10000 Mbps Ethernet connection with a device on the Local Area Network (LAN) through the 10G LAN port.
		Blinking	The Zyxel Device is sending or receiving data to/from the LAN at 10/100/10000 Mbps through the 10G LAN port.
		Off	The Zyxel Device does not have an Ethernet connection with the LAN through the 10G LAN port.
LAN1 – 4	Green	On	The Zyxel Device has a successful 10/100/1000 Mbps Ethernet connection with a device on the Local Area Network (LAN) through the LAN1 – 4 ports.
		Blinking	The Zyxel Device is sending or receiving data to/from the LAN at 10/100/1000 Mbps through the LAN1 – 4 ports.  Note: For AON and PON routers only; see <a href="#">Section 1.1 on page 19</a> for more information.
		Off	The Zyxel Device does not have an Ethernet connection with the LAN through the LAN1 – 4 ports.
WiFi 2.4G	Green	On	The 2.4G WiFi network is activated.
		Blinking	The Zyxel Device is communicating with 2.4G WiFi clients.  Note: For AON and PON routers only; see <a href="#">Section 1.1 on page 19</a> for more information.
		Off	The 2.4G WiFi network is not activated.
	Amber	Blinking	The Zyxel Device is setting up a WPS connection with a 2.4G WiFi client.

Table 5 LED Descriptions (AX7501) (continued)

LED	COLOR	STATUS	DESCRIPTION
WiFi 5G	Green	On	The 5G WiFi network is activated.
		Blinking	The Zyxel Device is communicating with 5G WiFi clients.  Note: For AON and PON routers only; see <a href="#">Section 1.1 on page 19</a> for more information.
		Off	The 5G WiFi network is not activated.
	Amber	Blinking	The Zyxel Device is setting up a WPS connection with a 5G WiFi client.
PHONE	Green	On	A SIP account is registered for the phone port.
		Blinking	The telephone connected to this phone port has an incoming call or is off the hook.
		Off	The phone port does not have a SIP account registered.
	Amber	On	A SIP account is registered for the phone port, and there is a voice message in the corresponding SIP account.
		Blinking	The telephone connected to this phone port has an incoming call or is off the hook. There is a voice message in the corresponding SIP account.
USB	Green	On	The Zyxel Device recognizes a USB connection through the USB port.
		Blinking	The Zyxel Device is sending or receiving data to/from the USB device connected to it.  Note: For AON and PON routers only; see <a href="#">Section 1.1 on page 19</a> for more information.
		Off	The Zyxel Device does not detect a USB connection through the USB port.

## 2.2.2 DX3300-T0, DX3301-T0, EX3300-T0 and EX3301-T0

Figure 11 LED Indicators (DX3300-T0 / DX3301-T0 / EX3300-T0 / EX3301-T0)



The following are the LED descriptions for your DX3300-T0 / EX3300-T0.

Table 6 LED Descriptions (DX3300-T0 / EX3300-T0)

LED	COLOR	STATUS	DESCRIPTION
Power	Green	On	The Zyxel Device is receiving power and ready for use.
		Blinking	The Zyxel Device is self-testing.
	Red	On	The Zyxel Device detected an error while self-testing, or there is a device malfunction.
		Blinking	The Zyxel Device is upgrading firmware.
	Off	The Zyxel Device is not receiving power.	
DSL / Ethernet WAN	Green	On	The VDSL/ ADSL link is up.
		Slow Blinking	The Zyxel Device is looking for a VDSL or ADSL link.
		Fast Blinking	The Zyxel Device is initializing the VDSL or ADSL link.



Table 6 LED Descriptions (DX3300-T0 / EX3300-T0)

LED	COLOR	STATUS	DESCRIPTION
Internet	Green	On	The Zyxel Device has an IP connection but no traffic. Your device has a WAN IP address (either static or assigned by a DHCP server), PPP negotiation was successfully completed (if used) and the DSL connection is up.
		Blinking	The Zyxel Device is sending or receiving IP traffic.
		Off	There is no Internet connection or the gateway is in bridged mode.
	Red	On	The Zyxel Device attempted to make an IP connection but failed. Possible causes are no response from a DHCP server, no PPPoE response, PPPoE authentication failed.
LAN1 – 4	Green	On	The Zyxel Device has a successful 10/100/1000 Mbps Ethernet connection with a device on the Local Area Network (LAN).
		Blinking	The Zyxel Device is sending or receiving data to/from the LAN at 10/100/1000 Mbps.
		Off	The Zyxel Device does not have an Ethernet connection with the LAN.
2.4G WLAN/WPS	Green	On	The 2.4 GHz WiFi network is activated.
		Blinking	The Zyxel Device is communicating with 2.4 GHz WiFi clients.
		Off	The link is down or disabled.
	Amber	Blinking	The Zyxel Device is setting up a WPS connection with a 2.4 GHz WiFi client.
5G WLAN/WPS	Green	On	The 5 GHz WiFi network is activated.
		Blinking	The Zyxel Device is communicating with 5 GHz WiFi clients.
		Off	The link is down or disabled.
	Amber	Blinking	The Zyxel Device is setting up a WPS connection with a 5 GHz WiFi client.

The following are the LED descriptions for your DX3301-T0 / EX3301-T0.

Table 7 LED Descriptions (DX3301-T0 / EX3301-T0)

LED	COLOR	STATUS	DESCRIPTION
Power	Green	On	The Zyxel Device is receiving power and ready for use.
		Blinking	The Zyxel Device is self-testing.
	Red	On	The Zyxel Device detected an error while self-testing, or there is a device malfunction.
		Blinking	The Zyxel Device is upgrading firmware.
		Off	The Zyxel Device is not receiving power.
DSL / Ethernet WAN	Green	On	The VDSL / ADSL link is up.
		Slow Blinking	The Zyxel Device is looking for a VDSL / ADSL link.
		Fast Blinking	The Zyxel Device is initializing the VDSL / ADSL link.

Table 7 LED Descriptions (DX3301-T0 / EX3301-T0) (continued)

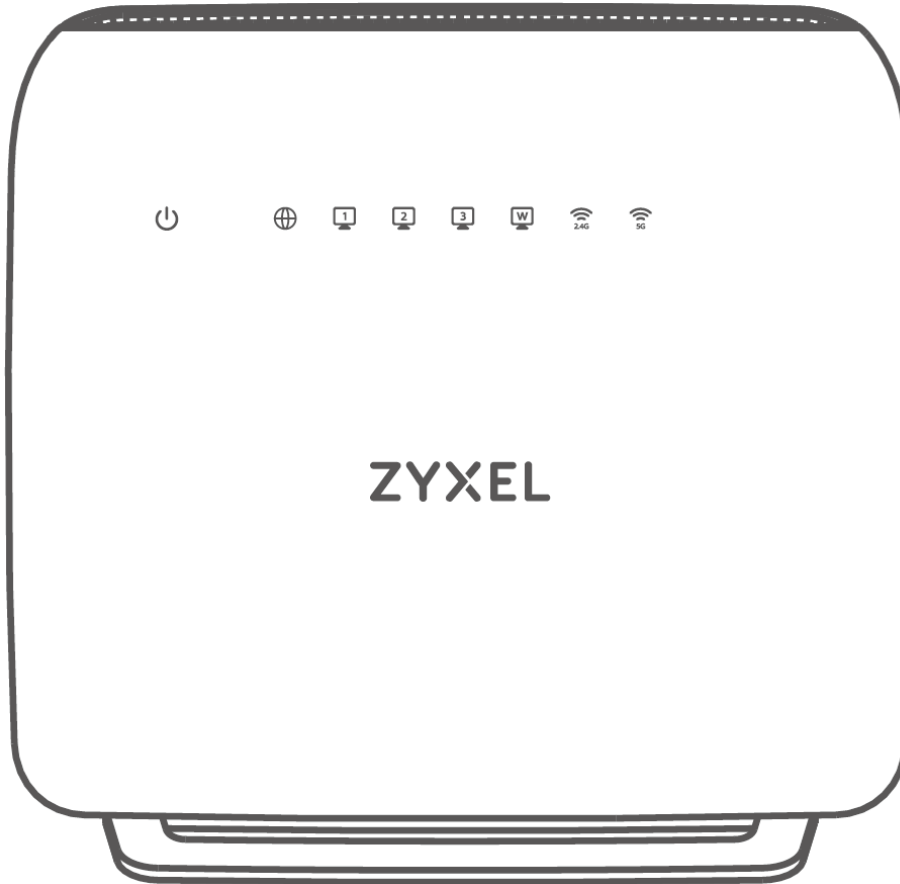
LED	COLOR	STATUS	DESCRIPTION
Internet	Green	On	The Zyxel Device has an IP connection but no traffic. Your device has a WAN IP address (either static or assigned by a DHCP server), PPP negotiation was successfully completed (if used) and the DSL connection is up.
		Blinking	The Zyxel Device is sending or receiving IP traffic.
		Off	There is no Internet connection or the gateway is in bridged mode.
	Red	On	The Zyxel Device attempted to make an IP connection but failed. Possible causes are no response from a DHCP server, no PPPoE response, PPPoE authentication failed.
LAN1 – 4	Green	On	The Zyxel Device has a successful 10/100/1000 Mbps Ethernet connection with a device on the Local Area Network (LAN).
		Blinking	The Zyxel Device is sending or receiving data to/from the LAN at 10/100/1000 Mbps.
		Off	The Zyxel Device does not have an Ethernet connection with the LAN.
2.4G WLAN/WPS	Green	On	The 2.4 GHz WiFi network is activated.
		Blinking	The Zyxel Device is communicating with 2.4 GHz WiFi clients.
		Off	The link is down or disabled.
	Amber	Blinking	The Zyxel Device is setting up a WPS connection with a 2.4 GHz WiFi client.
5G WLAN/WPS	Green	On	The 5 GHz WiFi network is activated.
		Blinking	The Zyxel Device is communicating with 5 GHz WiFi clients.
		Off	The link is down or disabled.
	Amber	Blinking	The Zyxel Device is setting up a WPS connection with a 5 GHz WiFi client.
Phone1, Phone2	Green	On	A SIP account is registered for at least one phone port, and there is no voice message in the corresponding SIP account.
		Blinking	A telephone connected to one of the phone port has its receiver off the hook or there is an incoming call. There is no voice message in the corresponding SIP account.
	Amber	On	A SIP account is registered for the phone port and there is a voice message in the corresponding SIP account.
		Blinking	A telephone connected to the phone port has its receiver off the hook or there is an incoming call. There is voice message in the corresponding SIP account.
		Off	<ul style="list-style-type: none"> <li>• The Zyxel Device is turned off.</li> <li>• The VoIP function is not activated.</li> <li>• The SIP account is not enabled.</li> <li>• The phone port does not have a SIP account registered.</li> </ul>

### 2.2.3 DX3300-T1 and EX3300-T1

Figure 12 DX3300-T1



Figure 13 EX3300-T1



The following are the LED descriptions for your DX3300-T1 and EX3300-T1.

Table 8 LED Descriptions (DX3300-T1 and EX-3300-T1)








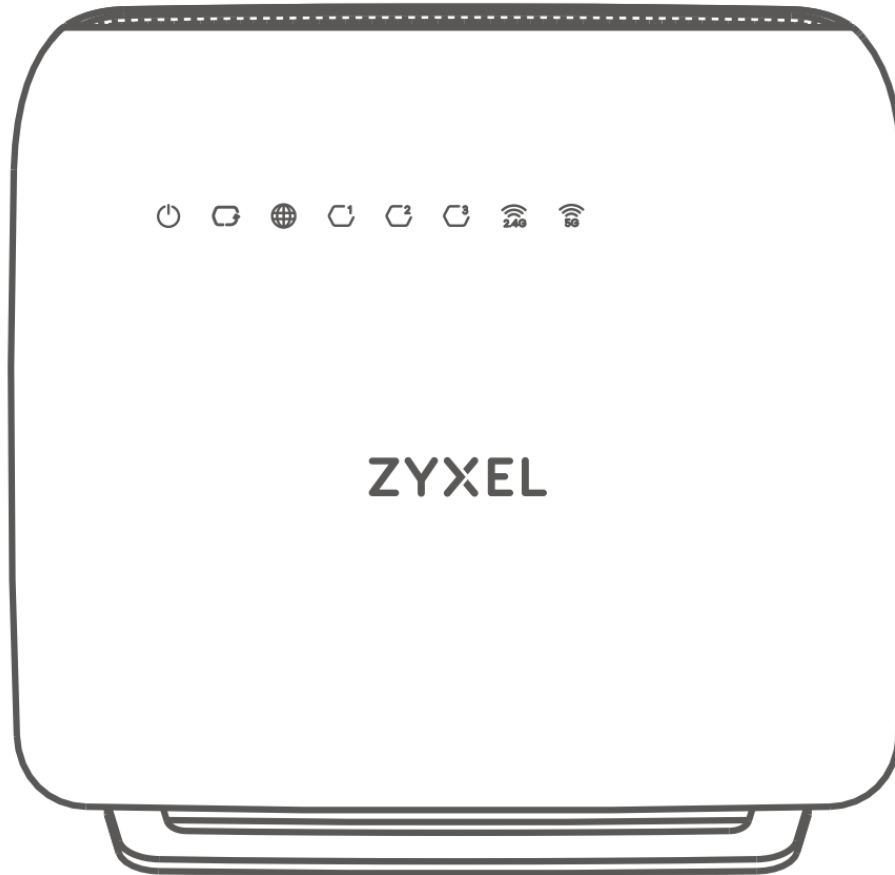
LED	COLOR	STATUS	DESCRIPTION
POWER 	Green	On	The Zyxel Device is receiving power and ready for use.
		Blinking	The Zyxel Device is booting up.
	Red	On	The Zyxel Device detects an error while self-testing, or there is a device malfunction.
		Blinking	The Zyxel Device is upgrading firmware.
		Off	The Zyxel Device is not receiving power.
DSL WAN 	Green	On	For DX3300-T1: The ADSL/VDSL link on the WAN is up.
		Slow Blinking	For DX3300-T1: The ADSL/VDSL link is down, and the Zyxel Device is looking for an ADSL/VDSL link.
		Fast Blinking	For DX3300-T1: The Zyxel Device is initializing the ADSL/VDSL link.
		Off	For DX3300-T1: The ADSL/VDSL link is down.

Table 8 LED Descriptions (DX3300-T1 and EX-3300-T1) (continued)

LED	COLOR	STATUS	DESCRIPTION
INTERNET 	Green	On	The Zyxel Device has a WAN IP address (either static or assigned by a DHCP server) and the Internet connection is up.
		Blinking	The Zyxel Device is sending or receiving traffic.
	Red	On	The Zyxel Device attempted to obtain a WAN IP but failed. Possible causes are no response from a DHCP server, no PPPoE response, PPPoE authentication failed.
		Off	There is no Internet connection or the gateway is in bridge mode.
LAN1-3 	Green	On	The Zyxel Device has a successful Ethernet connection with a device on the Local Area Network (LAN) port.
		Blinking	The Zyxel Device is sending or receiving data to/from the LAN port.
		Off	The Zyxel Device does not have an Ethernet connection on the LAN port.
LAN4/WAN 	Green	On	LAN mode: The Zyxel Device has a successful Ethernet connection with a device on the <b>LAN4/WAN</b> port.  WAN mode: The Ethernet WAN connection is up on the <b>LAN4/WAN</b> port.
		Blinking	The Zyxel Device is sending or receiving data to/from the <b>LAN4/WAN</b> port.
		Off	LAN mode: The Zyxel Device does not have an Ethernet connection with a device on the <b>LAN4/WAN</b> port.  WAN mode: The Ethernet WAN connection on the <b>LAN4/WAN</b> port is down.
2.4G 	Green	On	The 2.4 GHz WiFi is activated.
		Blinking	The Zyxel Device is sending or receiving data to/from 2.4 GHz WiFi clients.
	Amber	Blinking	The Zyxel Device is connecting to a 2.4 GHz WiFi client through WPS.
		Off	The 2.4 GHz WiFi network is not activated.
5G 	Green	On	The 5 GHz WiFi network is activated.
		Blinking	The Zyxel Device is sending or receiving data to/from 5 GHz WiFi clients.
	Amber	Blinking	The Zyxel Device is connecting to a 5 GHz WiFi client through WPS.
		Off	The 5 GHz WiFi network is not activated.

## 2.2.4 EX3500-T0 and EX3501-T0

Figure 14 LED Indicators (EX3500-T0 and EX3501-T0)



The following are the LED descriptions for your EX3500-T0 and EX3501-T0.

Table 9 LED Descriptions (EX3500-T0 and EX3501-T0)




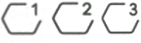



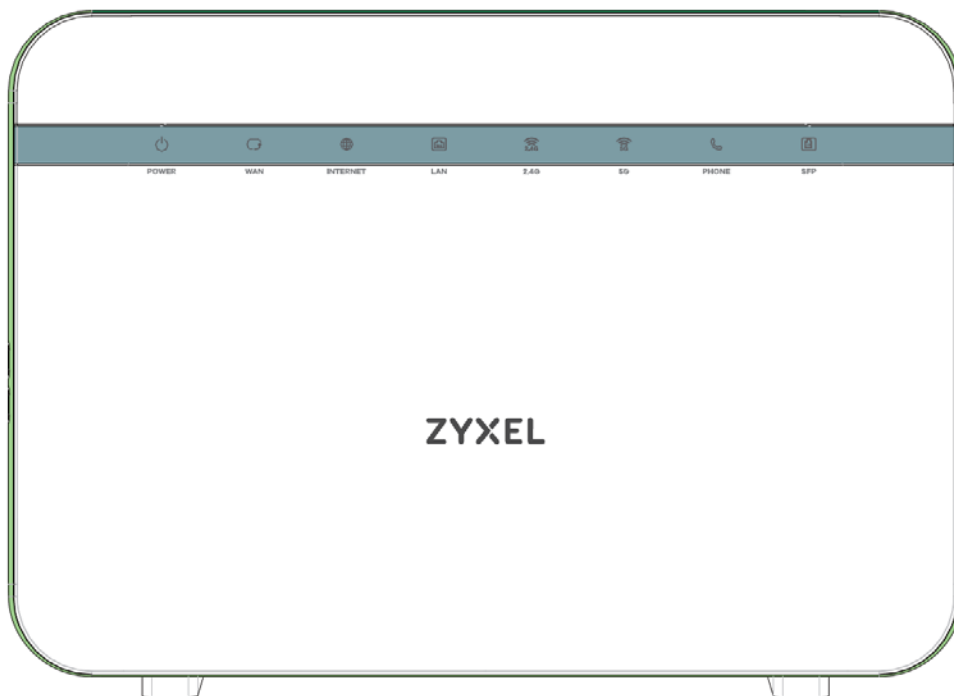
LED	COLOR	STATUS	DESCRIPTION
POWER 	Green	On	The Zyxel Device is receiving power and ready for use.
		Blinking	The Zyxel Device is booting up.
	Red	On	The Zyxel Device detects an error while self-testing, or there is a device malfunction.
		Blinking	The Zyxel Device is upgrading firmware.
	Off	The Zyxel Device is not receiving power.	
WAN 	Green	On	The Ethernet link on the WAN is up.
		Off	The Ethernet link on the WAN is down.
INTERNET 	Green	On	The Zyxel Device has a WAN IP address (either static or assigned by a DHCP server) and the Internet connection is up.
		Blinking	The Zyxel Device is sending or receiving Internet data.
	Red	On	The Zyxel Device attempted to obtain a WAN IP but failed. Possible causes are no response from a DHCP server, no PPPoE response, PPPoE authentication failed.
		Off	There is no Internet connection or the gateway is in bridge mode.

Table 9 LED Descriptions (EX3500-T0 and EX3501-T0) (continued)

LED	COLOR	STATUS	DESCRIPTION
LAN1-3 	Green	On	The Zyxel Device has a successful Ethernet connection with a device on the Local Area Network (LAN) port.
		Blinking	The Zyxel Device is sending or receiving data to/from the LAN port.
		Off	The Zyxel Device does not have an Ethernet connection on the LAN port.
2.4G 	Green	On	The 2.4 GHz WiFi is activated.
		Blinking	The Zyxel Device is sending or receiving data to/from 2.4 GHz WiFi clients.
	Amber	Blinking	The Zyxel Device is connecting to a 2.4 GHz WiFi client through WPS.
		Off	The 2.4 GHz WiFi network is not activated.
5G 	Green	On	The 5 GHz WiFi network is activated.
		Blinking	The Zyxel Device is sending or receiving data to/from 5 GHz WiFi clients.
	Amber	Blinking	The Zyxel Device is connecting to a 5 GHz WiFi client through WPS.
		Off	The 5 GHz WiFi network is not activated.
Phone1, Phone2 	Green	On	A SIP account is registered for at least one phone port, and there is no voice message in the corresponding SIP account.
		Blinking	A telephone connected to one of the phone port has its receiver off the hook or there is an incoming call. There is no voice message in the corresponding SIP account.
	Amber	On	A SIP account is registered for the phone port and there is a voice message in the corresponding SIP account.
		Blinking	A telephone connected to the phone port has its receiver off the hook or there is an incoming call. There's voice message in the corresponding SIP account.
		Off	The phone port has a telephone connection, but it is not in use. VoIP is disabled, or there is no registered SIP account defined for the phone port.

## 2.2.5 DX5401-B0/1 and EX5401-B0/1

Figure 15 LED Indicators (DX5401-B0 / DX5401-B1 / EX5401-B0 / EX5401-B1)



Note: The phone LED is for the Zyxel Device with phone ports only; see [Section 1.1 on page 19](#) for more information.

The following are the LED descriptions for your DX5401-B0/B1 and EX5401-B0/B1.

Table 10 LED Descriptions (DX5401-B0/B1 and EX5401-B0/B1)






LED	COLOR	STATUS	DESCRIPTION
Power 	Green	On	The Zyxel Device is receiving power and ready for use.
		Blinking	The Zyxel Device is self-testing.
	Red	On	The Zyxel Device detects an error while self-testing, or there is a device malfunction.
		Blinking	The Zyxel Device is upgrading firmware.
		Off	The Zyxel Device is not receiving power.
DSL / Ethernet WAN 	Green	On	The VDSL line or a successful 10/100/1000 Mbps Ethernet connection on the WAN is up.
		Slow Blinking	The Zyxel Device is looking for a VDSL line.
		Fast Blinking	The Zyxel Device is initializing the VDSL line.
		Off	There is no Ethernet connection on the WAN.
	Amber	On	The ADSL line on the WAN is up.
		Slow Blinking	The Zyxel Device is looking for an ADSL line
		Fast Blinking	The Zyxel Device is initializing the ADSL line.



Table 10 LED Descriptions (DX5401-B0/B1 and EX5401-B0/B1) (continued)

LED	COLOR	STATUS	DESCRIPTION
Internet 	Green	On	The Zyxel Device has an IP connection but no traffic. Your device has a WAN IP address (either static or assigned by a DHCP server), PPP negotiation was successfully completed (if used) and the DSL connection is up.
		Blinking	The Zyxel Device is sending or receiving IP traffic.
		Off	There is no Internet connection or the gateway is in bridged mode.
	Red	On	The Zyxel Device attempted to make an IP connection but failed. Possible causes are no response from a DHCP server, no PPPoE response, PPPoE authentication failed.
LAN1 – 4 	Green	On	The Zyxel Device has a successful 10/100/1000 Mbps Ethernet connection with a device on the Local Area Network (LAN).
		Blinking	The Zyxel Device is sending or receiving data to/from the LAN at 10/100/1000 Mbps.
		Off	The Zyxel Device does not have an Ethernet connection with the LAN.
2.4G WLAN/ WPS 	Green	On	The 2.4 GHz WiFi network is activated.
		Blinking	The Zyxel Device is communicating with 2.4 GHz WiFi clients.
	Amber	On	The WPS process fails.
		Blinking	The Zyxel Device is setting up a WPS connection with a 2.4 GHz WiFi client.
5G WLAN/ WPS 	Green	On	The 5 GHz WiFi network is activated.
		Blinking	The Zyxel Device is communicating with 5 GHz WiFi clients.
	Amber	On	The WPS process fails.
		Blinking	The Zyxel Device is setting up a WPS connection with a 5 GHz WiFi client.
Phone1, Phone2 	Green	On	A SIP account is registered for at least one phone port, and there is no voice message in the corresponding SIP account.
		Blinking	A telephone connected to one of the phone port has its receiver off the hook or there is an incoming call. There is no voice message in the corresponding SIP account.
	Amber	On	A SIP account is registered for the phone port and there is a voice message in the corresponding SIP account.
		Blinking	A telephone connected to the phone port has its receiver off the hook or there is an incoming call. There's voice message in the corresponding SIP account.

## 2.2.6 EX5600-T1, EX5601-T0 and EX5601-T1

Figure 16 LED Indicators (EX5600-T1)

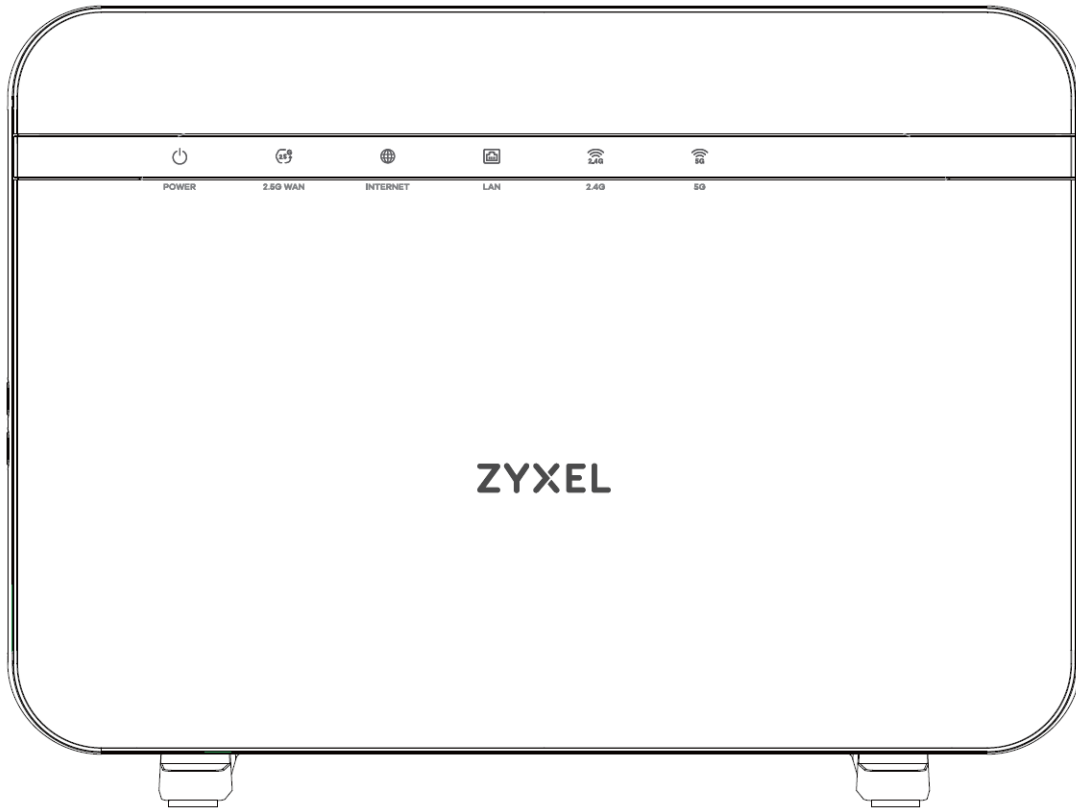


Figure 17 LED Indicators (EX5601-T0)

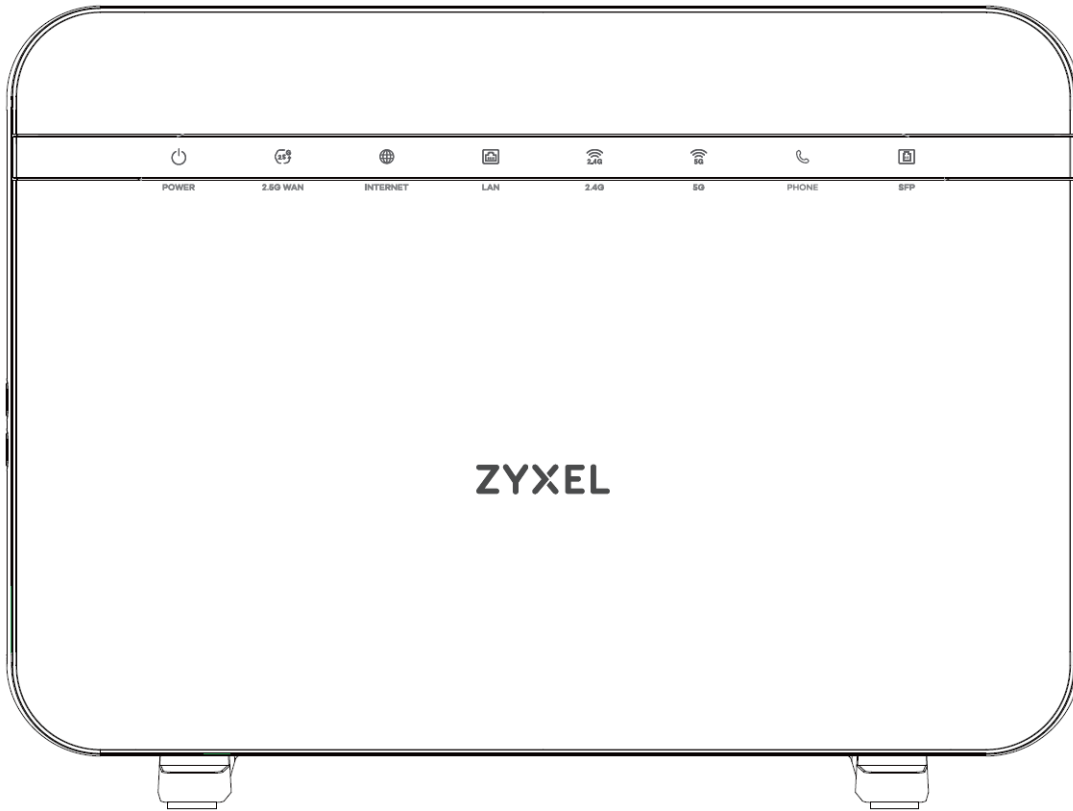
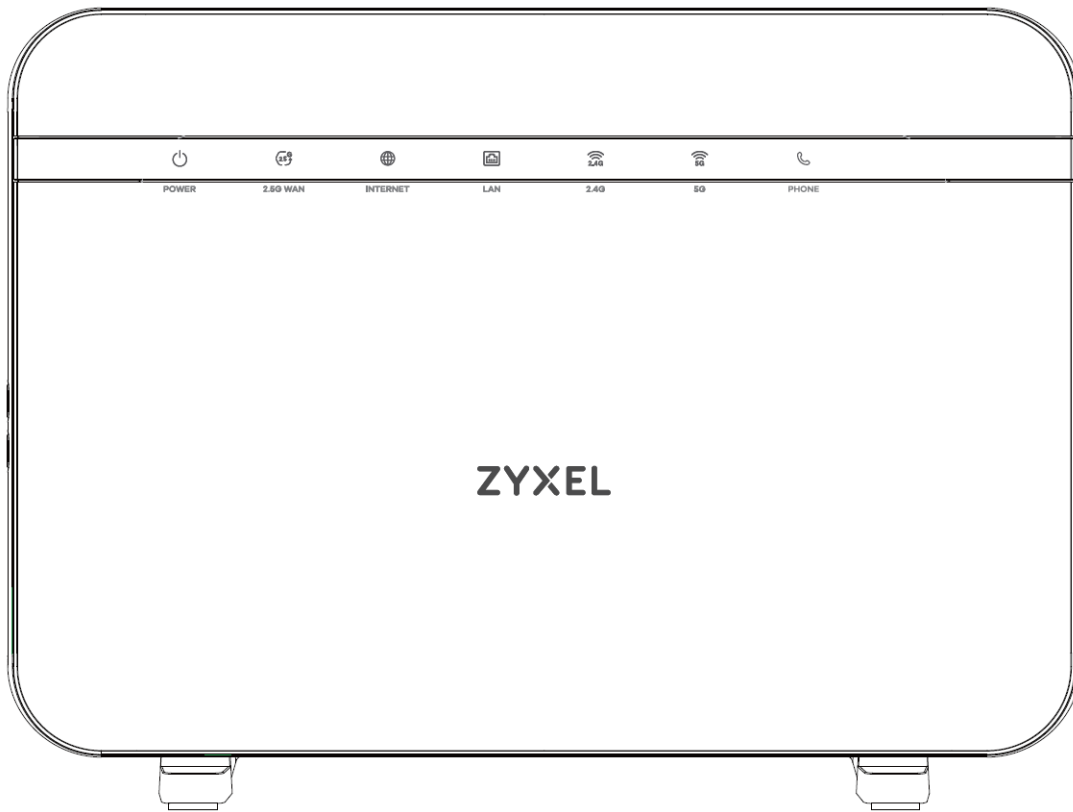


Figure 18 LED Indicators (EX5601-T1)



Note: The Phone LED is for the Zyxel Device with phone ports only; the SFP LED is for the Zyxel Device with an SFP port only; see [Section 1.1 on page 19](#) for more information.

The following are the LED descriptions for your EX5600-T1 / EX5601-T0/ EX5601-T1.

Table 11 LED Descriptions (EX5600-T1 / EX5601-T0/ EX5601-T1)









LED	COLOR	STATUS	DESCRIPTION
POWER 	Green	On	The Zyxel Device is receiving power and ready for use.
		Blinking	The Zyxel Device is booting up.
	Red	On	The Zyxel Device detects an error while self-testing, or there is a device malfunction.
		Blinking	The Zyxel Device is upgrading firmware.
	Off	The Zyxel Device is not receiving power.	
2.5G WAN 	Green	On	The Zyxel Device has a successful Ethernet connection on the 2.5G WAN port.
		Off	The Zyxel Device does not have an Ethernet connection on the 2.5G WAN port.
INTERNET 	Green	On	The Zyxel Device has a WAN IP address (either static or assigned by a DHCP server) and the Internet connection is up.
		Blinking	The Zyxel Device is sending or receiving traffic.
		Off	There is no Internet connection or the gateway is in bridged mode.
	Red	On	The Zyxel Device attempted to obtain a WAN IP but failed. Possible causes are no response from a DHCP server, no PPPoE response, PPPoE authentication failed.
LAN 	Green	On	The Zyxel Device has a successful Ethernet connection with a device on the Local Area Network (LAN).
		Blinking	The Zyxel Device is sending or receiving data to/from the LAN.
		Off	The Zyxel Device does not have an Ethernet connection on the LAN.
2.4G 	Green	On	The 2.4 GHz WiFi is activated.
		Blinking	The Zyxel Device is communicating with 2.4 GHz WiFi clients.
	Amber	Blinking	The Zyxel Device is setting up a WPS connection with a 2.4 GHz WiFi client.
		Off	The 2.4 GHz WiFi network is not activated.
5G 	Green	On	The 5 GHz WiFi network is activated.
		Blinking	The Zyxel Device is communicating with 5 GHz WiFi clients.
	Amber	Blinking	The Zyxel Device is connecting to 5 GHz WiFi clients via WPS.
		Off	The 5 GHz WiFi network is not activated.
Phone 	Green	On	All phone ports are on-hook. An SIP account is registered for at least one phone port, and there is no voice message in the corresponding SIP account.
		Blinking	A telephone connected to one of the phone port has its receiver off the hook or there is an incoming call. There is no voice message in the corresponding SIP account.
	Amber	On	A SIP account is registered for the phone port and there is a voice message in the corresponding SIP account.
		Blinking	A telephone connected to the phone port has its receiver off the hook or there is an incoming call. There's voice message in the corresponding SIP account.
		Off	All phone ports are on-hook. The VoIP function is disabled, or there is no registered SIP account defined for any of the phone ports.

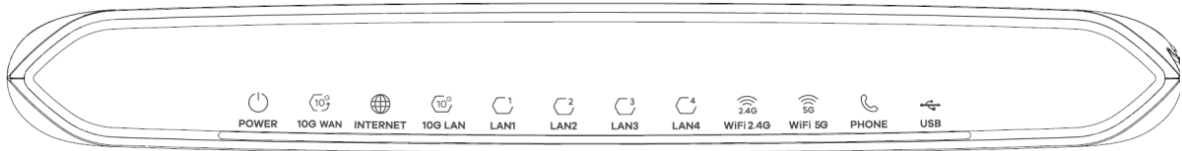
Table 11 LED Descriptions (EX5600-T1 / EX5601-T0/ EX5601-T1) (continued)

LED	COLOR	STATUS	DESCRIPTION
SFP 	Green	On	The SFP port is connected to the ISP's ONT and the Zyxel Device is receiving optical signals normally, or the SFP port's Ethernet WAN connection is up.
		Off	The connection to the ISP's ONT or the Ethernet WAN connection is down.

Note: The phone LED is for the Zyxel Device with phone ports only; see [Section 1.1 on page 19](#) for more information.

## 2.2.7 EX7501-B0

Figure 19 LED Indicators



The following are the LED descriptions for your EX7501-B0.

Table 12 LED Descriptions (EX7501-B0)










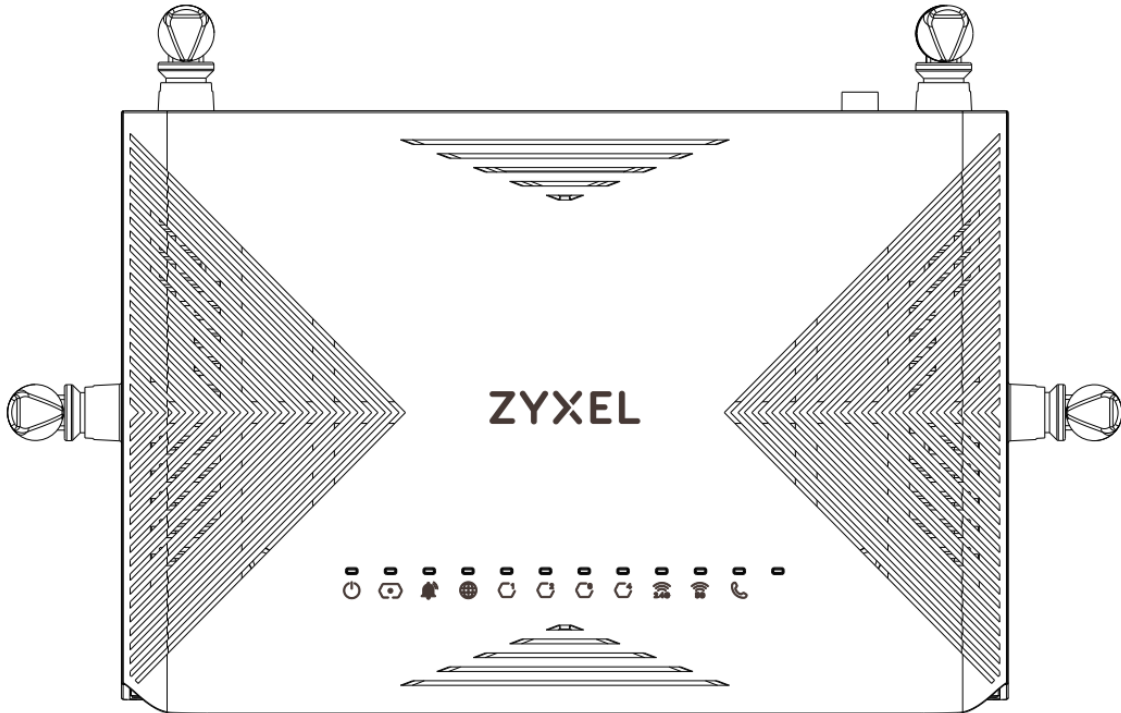
LED	COLOR	STATUS	DESCRIPTION
POWER 	Green	On	The Zyxel Device is receiving power and ready for use.
		Blinking	The Zyxel Device is booting up.
	Red	On	The Zyxel Device detects an error while self-testing, or there is a device malfunction.
		Blinking	The Zyxel Device is upgrading firmware.
	Off	The Zyxel Device is not receiving power.	
10G WAN 	Green	On	The Zyxel Device has a successful Ethernet connection on the 10G WAN port.
		Off	The Zyxel Device does not have an Ethernet connection on the 10G WAN port.
INTERNET 	Green	On	The Zyxel Device has a WAN IP address (either static or assigned by a DHCP server) and the Internet connection is up.
		Blinking	The Zyxel Device is sending or receiving traffic.
		Off	There is no Internet connection or the gateway is in bridged mode.
	Red	On	The Zyxel Device attempted to obtain a WAN IP but failed. Possible causes are no response from a DHCP server, no PPPoE response, PPPoE authentication failed.
10G LAN 	Green	On	The Zyxel Device has a successful Ethernet connection with a device on the 10G LAN (Local Area Network) port.
		Blinking	The Zyxel Device is sending or receiving data to/from the 10G LAN port.
		Off	The Zyxel Device does not have an Ethernet connection on the 10G LAN port.

Table 12 LED Descriptions (EX7501-B0) (continued)

LED	COLOR	STATUS	DESCRIPTION
LAN1-4 	Green	On	The Zyxel Device has a successful Ethernet connection with a device on the LAN (Local Area Network) port.
		Blinking	The Zyxel Device is sending or receiving data to/from the LAN port.
		Off	The Zyxel Device does not have an Ethernet connection on the LAN port.
2.4G  2.4G	Green	On	The 2.4 GHz WiFi is activated.
		Blinking	The Zyxel Device is communicating with 2.4 GHz WiFi clients.
	Amber	Blinking	The Zyxel Device is setting up a WPS connection with a 2.4 GHz WiFi client.
		Off	The 2.4 GHz WiFi network is not activated.
5G  5G	Green	On	The 5 GHz WiFi network is activated.
		Blinking	The Zyxel Device is communicating with 5 GHz WiFi clients.
	Amber	Blinking	The Zyxel Device is connecting to 5 GHz WiFi clients via WPS.
		Off	The 5 GHz WiFi network is not activated.
Phone 	Green	On	All phone ports are on-hook. An SIP account is registered for at least one phone port, and there is no voice message in the corresponding SIP account.
		Blinking	At least one telephone connected to one of the phone ports has its receiver off the hook or there is an incoming call. There is no voice message in the corresponding SIP account.
	Amber	On	All phone ports are on-hook. A SIP account is registered for the phone port and there is a voice message in the corresponding SIP account.
		Blinking	At least one telephone connected to the phone port has its receiver off the hook or there is an incoming call. There's voice message in the corresponding SIP account.
	Off	All phone ports are on-hook. The VoIP function is disabled, or there is no registered SIP account defined for any of the phone ports.	
USB 	Green	On	A device is connected to the USB port.
		Off	There is currently no device connected to the USB port.

## 2.2.8 PX3321-T1

Figure 20 LED Indicators (PX3321-T1)



The following are the LED descriptions for your PX3321-T1.

Table 13 LED Descriptions (PX3321-T1)

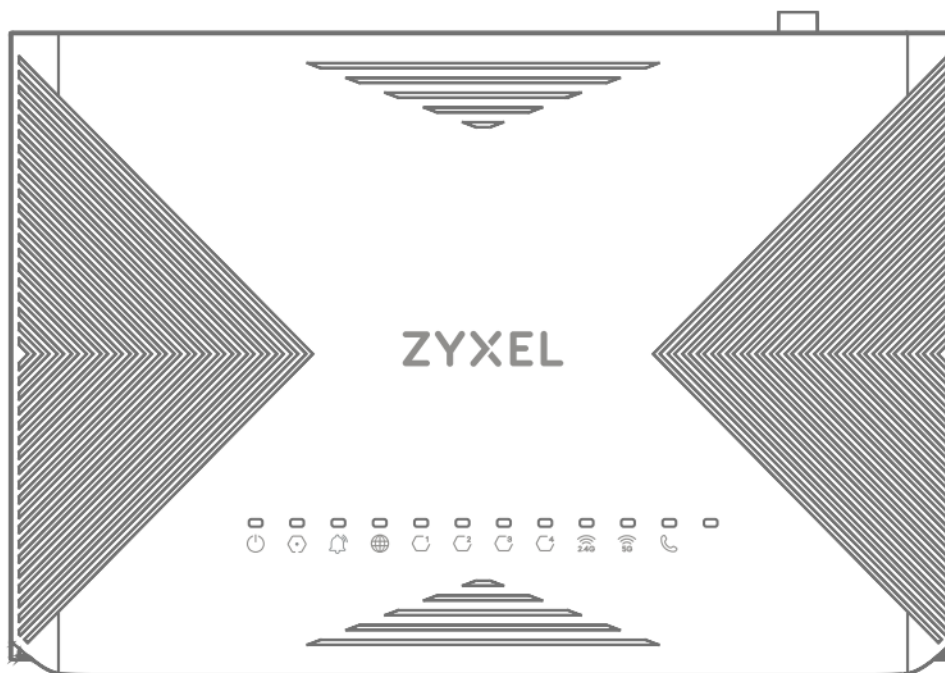
LED	COLOR	STATUS	DESCRIPTION
POWER	Green	On	The Zyxel Device is receiving power and ready for use.
		Blinking Slow	The Zyxel Device is booting up.
		Blinking Fast	The Zyxel Device is trying to boot up but failed.
		Off	The Zyxel Device is not receiving power.
PON	Green	On	The Zyxel Device is ready for PON connection.
		Blinking	The Zyxel Device is setting up a PON connection.
		Off	The Zyxel Device is not receiving an optical signal.
LOS	Red	On	The PON transceiver is not receiving an optical signal.
		Blinking	The optical signal the PON transceiver receiving is too weak or too strong.
		Off	The PON connection is ready.
INTERNET	Green	On	The Zyxel Device has a WAN IP address (either static or assigned by a DHCP server) and the Internet connection is up.
		Blinking	The Zyxel Device is sending or receiving Internet data.
		Off	The Zyxel Device's WAN connection is down or in <b>Bridge</b> mode. You can select modes on the <b>Network Setting &gt; Broadband &gt; Modify</b> screen.
	Red	On	The Zyxel Device attempted to obtain a WAN IP but failed. Possible causes are no response from a DHCP server, no PPPoE response, PPPoE authentication failed.

Table 13 LED Descriptions (PX3321-T1) (continued)

LED	COLOR	STATUS	DESCRIPTION
LAN 1-4	Green	On	The Zyxel Device has a successful Ethernet connection with a device on the LAN (Local Area Network) port.
		Blinking	The Zyxel Device is sending or receiving data to/from the LAN port.
		Off	The Zyxel Device does not have an Ethernet connection on the LAN port.
2.4G	Green	On	The 2.4 GHz WiFi is activated.
		Blinking	The Zyxel Device is communicating with 2.4 GHz WiFi clients.
		Off	The 2.4 GHz WiFi network is not activated.
	Amber	Blinking	The Zyxel Device is setting up a WPS connection with a 2.4 GHz WiFi client.
5G	Green	On	The 5 GHz WiFi network is activated.
		Blinking	The Zyxel Device is communicating with 5 GHz WiFi clients.
		Off	The 5 GHz WiFi network is not activated.
	Amber	Blinking	The Zyxel Device is connecting to 5 GHz WiFi clients via WPS.
Phone	Green	On	The phone port has a telephone connection, but it is not in use. A SIP account is registered for the phone port.
		Blinking	The phone port has a telephone connection, and it is in use.
		Off	The phone port has a telephone connection, but it is not in use. VoIP is disabled, or there is no registered SIP account defined for the phone port.

## 2.2.9 PX5311-T0

Figure 21 LED Indicators (PX5531-T0)





The following are the LED descriptions for your PX5531-T0.

Table 14 LED Descriptions (PX5531-T0)

LED	COLOR	STATUS	DESCRIPTION
POWER	Green	On	The Zyxel Device is receiving power and ready for use.
		Blinking Slow	The Zyxel Device is booting up.
		Blinking Fast	The Zyxel Device is trying to boot up but failed.
		Off	The Zyxel Device is not receiving power.
PON	Green	On	The Zyxel Device is ready for PON connection.
		Blinking	The Zyxel Device is setting up a PON connection.
		Off	The Zyxel Device is not receiving an optical signal.
LOS	Red	On	The PON transceiver is not receiving an optical signal.
		Blinking	The optical signal the PON transceiver receiving is too weak or too strong.
		Off	The PON connection is ready.
INTERNET	Green	On	The Zyxel Device has a WAN IP address (either static or assigned by a DHCP server) and the Internet connection is up.
		Blinking	The Zyxel Device is sending or receiving Internet data.
		Off	The Zyxel Device's WAN connection is down or in <b>Bridge</b> mode. You can select modes on the <b>Network Setting &gt; Broadband &gt; Modify</b> screen.
	Red	On	The Zyxel Device attempted to obtain a WAN IP but failed. Possible causes are no response from a DHCP server, no PPPoE response, PPPoE authentication failed.
LAN 1-4	Green	On	The Zyxel Device has a successful Ethernet connection with a device on the LAN (Local Area Network) port.
		Blinking	The Zyxel Device is sending or receiving data to/from the LAN port.
		Off	The Zyxel Device does not have an Ethernet connection on the LAN port.
2.4G	Green	On	The 2.4 GHz WiFi is activated.
		Blinking	The Zyxel Device is communicating with 2.4 GHz WiFi clients.
		Off	The 2.4 GHz WiFi network is not activated.
	Amber	Blinking	The Zyxel Device is setting up a WPS connection with a 2.4 GHz WiFi client.
5G	Green	On	The 5 GHz WiFi network is activated.
		Blinking	The Zyxel Device is communicating with 5 GHz WiFi clients.
		Off	The 5 GHz WiFi network is not activated.
	Amber	Blinking	The Zyxel Device is connecting to 5 GHz WiFi clients via WPS.
Phone	Green	On	The phone port has a telephone connection, but it is not in use. A SIP account is registered for the phone port.
		Blinking	The phone port has a telephone connection, and it is in use.
		Off	The phone port has a telephone connection, but it is not in use. VoIP is disabled, or there is no registered SIP account defined for the phone port.

## 2.3 Ports Panel

The following shows the Zyxel Device ports panel and connection ports.

### 2.3.1 AX7501

Figure 22 AX7501-B0

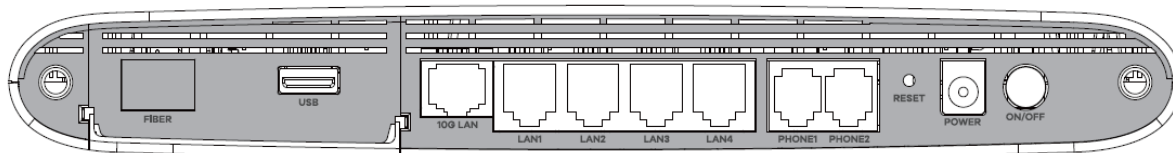
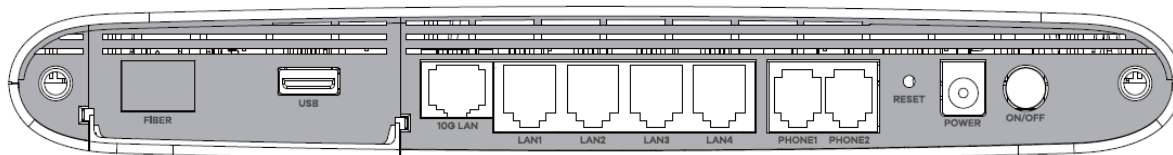


Figure 23 AX7501-B1



The following table describes the items on the ports panels of AX7501.

Table 15 Panel Ports and Buttons

LABEL	DESCRIPTION
FIBER	For AX7501-B0 / AX7501-B1 Insert a compatible SFP+ transceiver to the FIBER port and connect the fiber cable for Internet access.
USB	The USB port is used for cellular WAN backup, file-sharing, and media server.
LAN1 – LAN4 2.5G LAN 10G LAN	Connect computers or other Ethernet devices to Ethernet ports for Internet access.
PHONE1/2	Connect analog phones to the PHONE ports to make phone calls.
RESET	Press the button to return the Zyxel Device to the factory defaults.
POWER	Connect the power adapter and press the ON/OFF button to start the device.
WPS	Press the WPS button for more than 5 seconds to quickly set up a secure WiFi connection between the device and a WPS-compatible client.
WLAN	Press the WLAN button for more than 2 seconds to enable the WiFi function.

### 2.3.2 DX3300-T0, DX3301-T0, DX5401-B0/B1, EX3300-T0, EX3301-T0 and EX5401-B0/B1

Figure 24 DX3300-T0



Figure 25 DX3301-T0



Figure 26 DX5401-B0/DX5401-B1

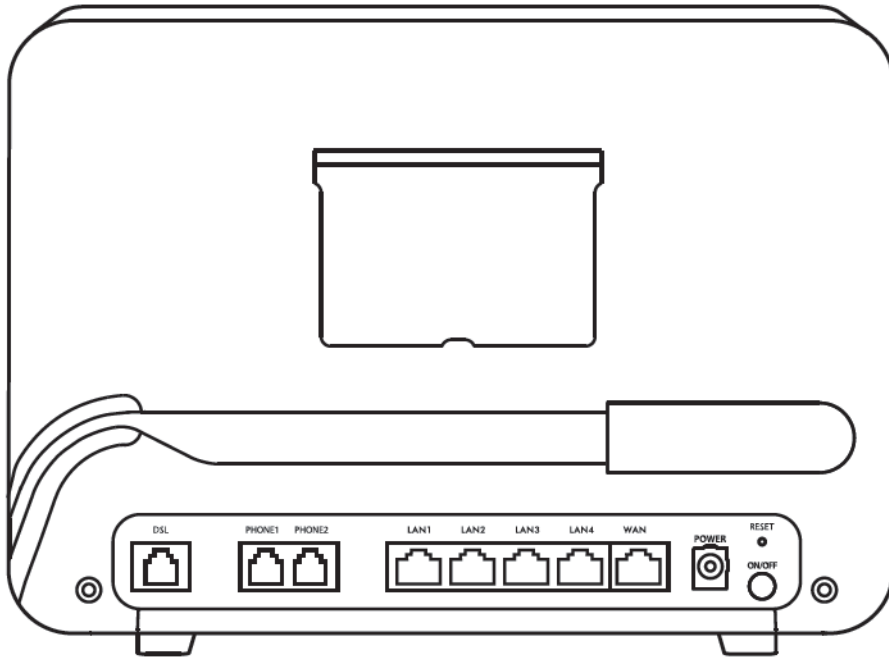


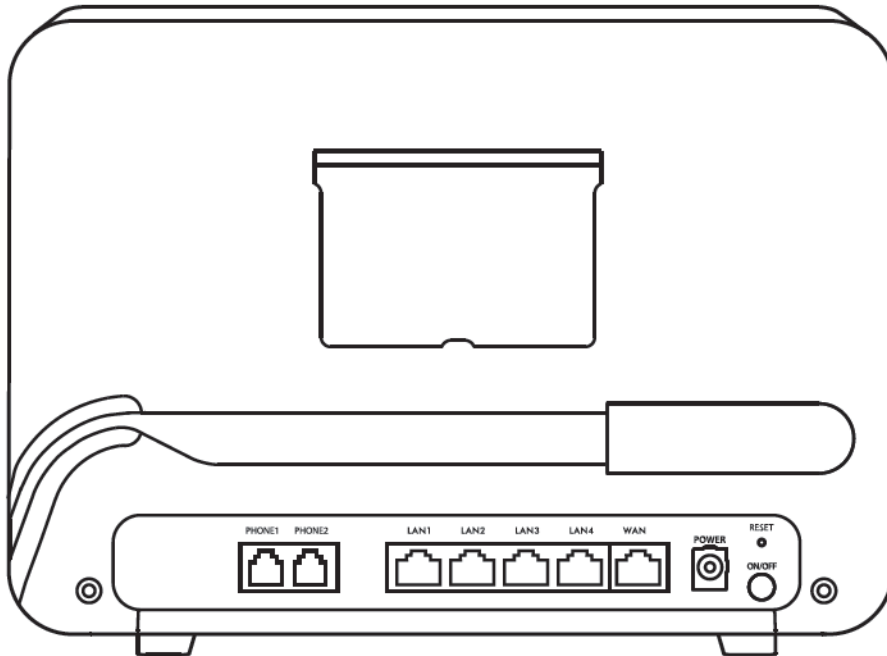
Figure 27 EX3300-T0



Figure 28 EX3301-T0



Figure 29 EX5401-B0 / EX5401-B1



The following table describes the items on the ports panels of DX3300-T0, DX3301-T0, DX5401-B0/B1, EX3300-T0, EX3301-T0 and EX5401-B0/B1.

Table 16 Panel Ports and Buttons

LABEL	DESCRIPTION
WAN	For EX3300-T0, EX3301-T0 and EX5401-B0/B1, use an Ethernet cable to connect the WAN port to a gateway/modem for Internet connection.
LAN1 – LAN4	Connect computers or other Ethernet devices to Ethernet ports for Internet access.
FIBER	For DX5401-B0 and EX5401-B0/B1, Insert a compatible SFP transceiver to the FIBER port and connect the fiber cable for Internet access.
USB	The USB port is used for cellular WAN backup, file-sharing, and media server.
DSL	For DX3300-T0, DX3301-T0 and DX5401-B0/B1, connect a DSL cable to the <b>DSL</b> port for Internet connection.
PHONE1/2	For DX3301-T0, DX5401-B0/B1, EX3301-T0, and EX5401-B0/B1, connect analog phones to the <b>PHONE</b> ports to make phone calls.
RESET	Press the button to return the Zyxel Device to the factory defaults.
POWER	Connect the power adapter and press the <b>ON/OFF</b> button to start the device.
WPS	Press the <b>WPS</b> button once within 3 seconds to quickly setup a secure WiFi connection between the device and a WPS-compatible client.
WLAN	Press the <b>WLAN</b> button for more than 2 seconds to enable the WiFi function.

### 2.3.3 DX3300-T1 and EX3300-T1

Figure 30 DX3300-T1

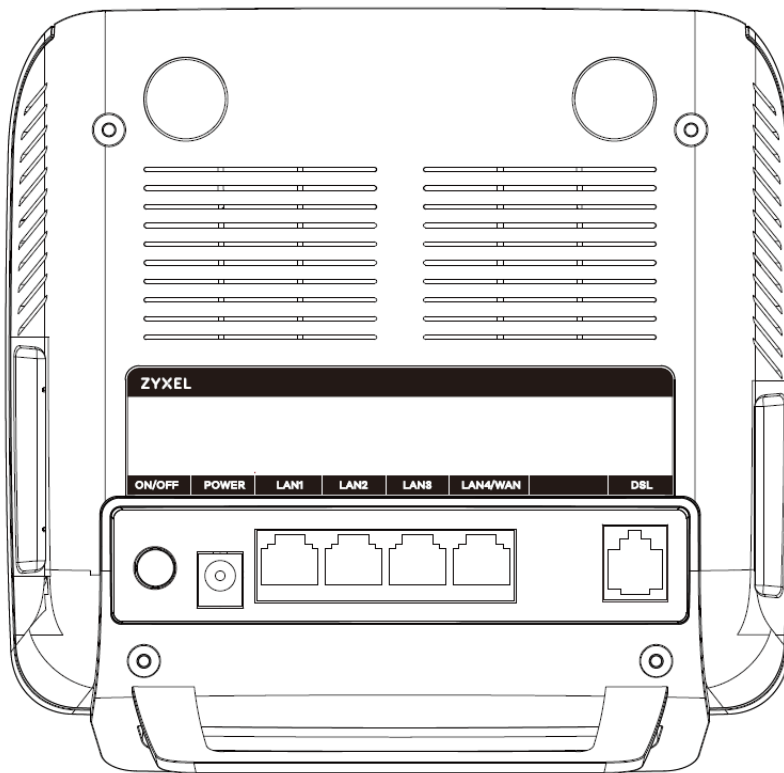
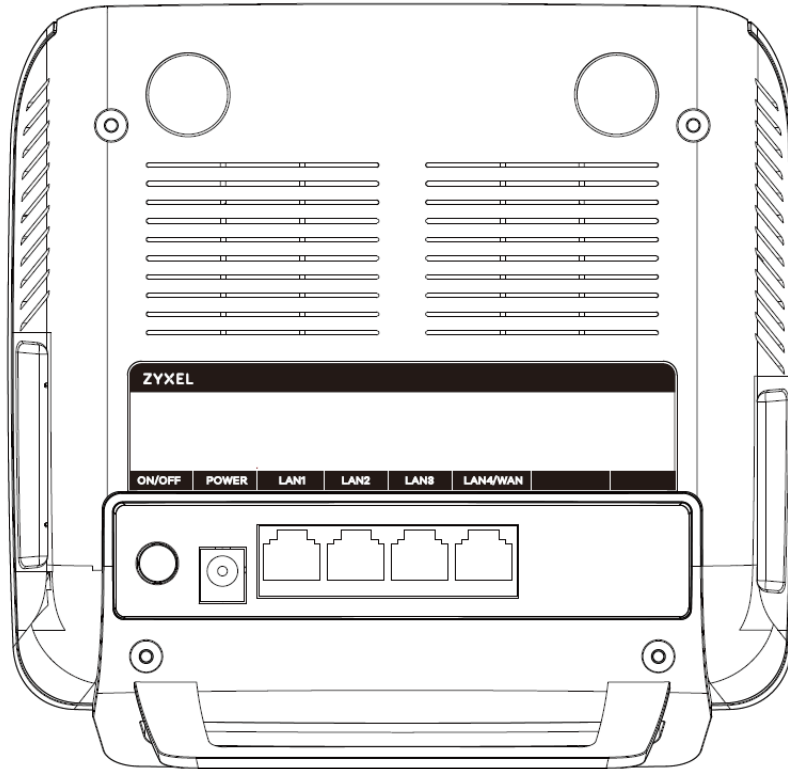


Figure 31 EX3300-T1



The following table describes the items on the ports panels of DX3300-T1 and EX3300-T1.

Table 17 Panel Ports and Buttons

LABEL	DESCRIPTION
DSL	For DX3300-T1, connect a DSL cable to the <b>DSL</b> port for Internet connection.
LAN1 – LAN3	Connect computers or other Ethernet devices to Ethernet ports for Internet access.
LAN4/WAN	LAN mode: Connect computers or other Ethernet devices to the <b>LAN4/WAN</b> port for Internet access. WAN mode: Connect the <b>LAN4/WAN</b> port to a gateway/modem with an Ethernet cable for Internet connection.
USB	The USB port is used for cellular WAN backup, file-sharing, and media server.
RESET	Press the button to return the Zyxel Device to the factory defaults.
POWER	Connect the power adapter and press the <b>ON/OFF</b> button to start the device.
WLAN	Press the <b>WLAN</b> button for more than 1 second to enable the WiFi function.
WPS	Press the <b>WPS</b> button once within 3 seconds to quickly setup a secure WiFi connection between the device and a WPS-compatible client.

### 2.3.4 EX3500-T0 and EX3501-T0

Figure 32 EX3500-T0

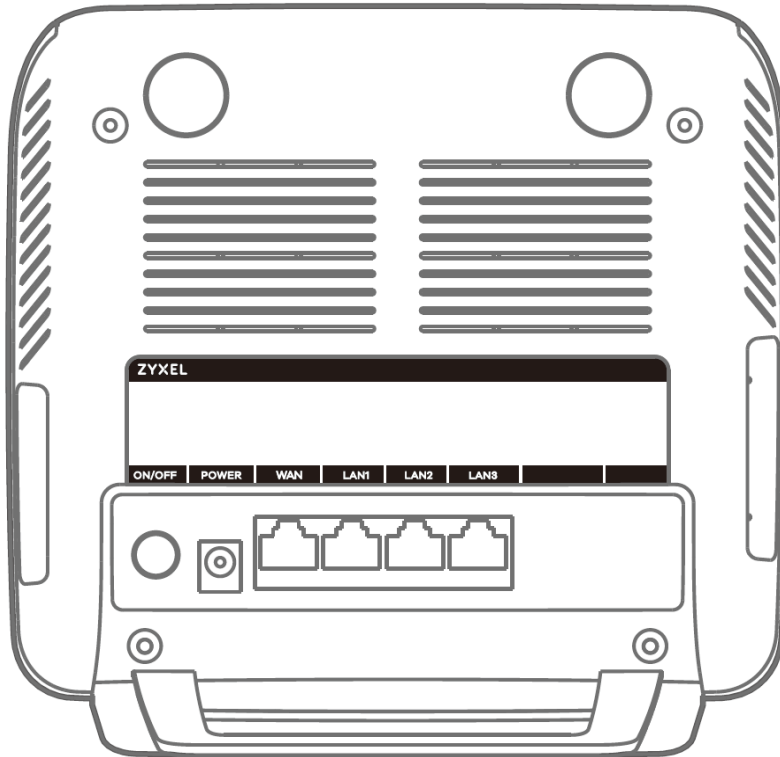
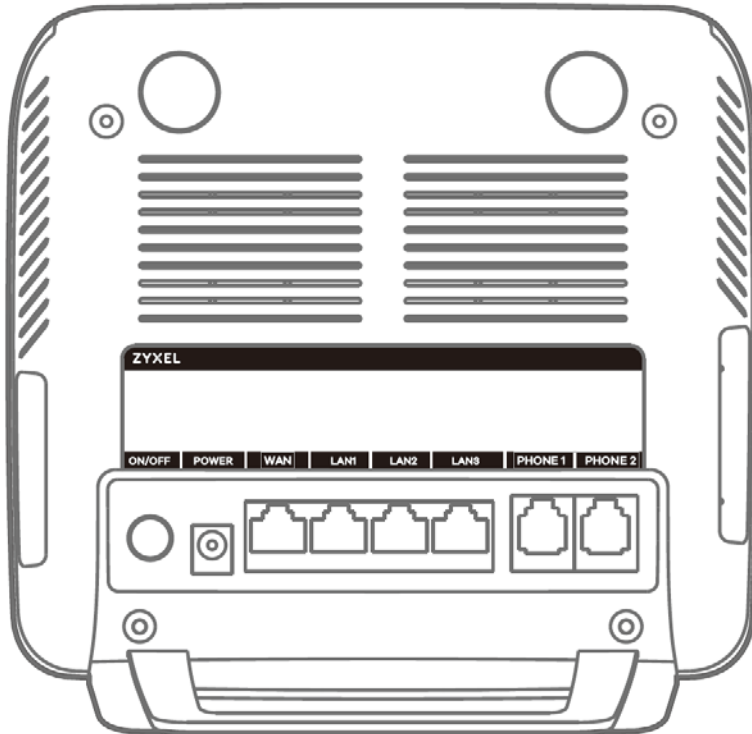


Figure 33 EX3501-T0





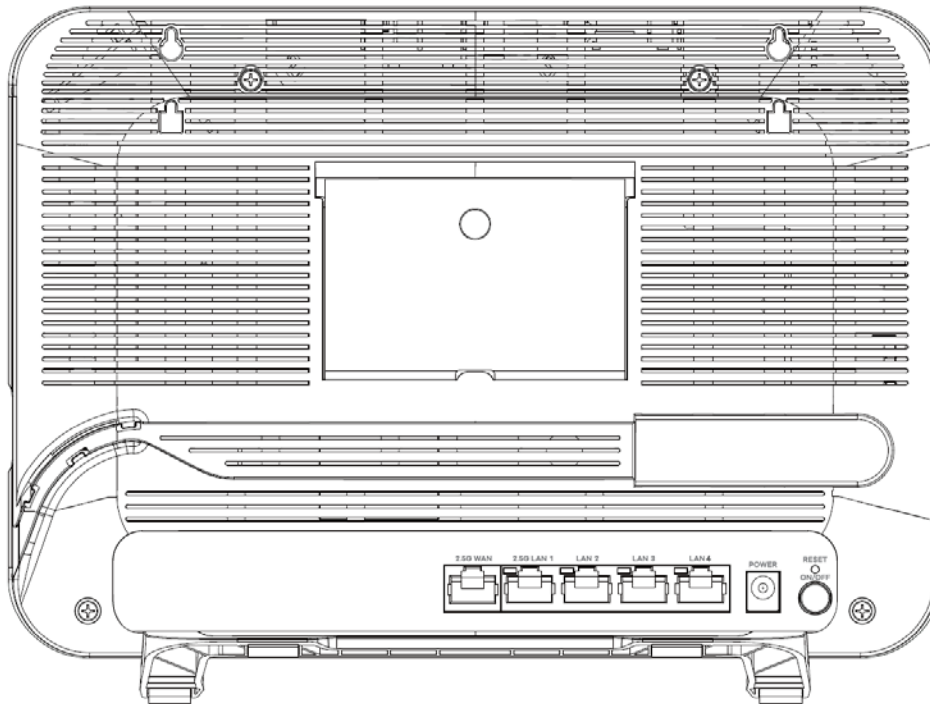
The following table describes the items on the ports panels of EX3500-T0 and EX3501-T0.

Table 18 Panel Ports and Buttons

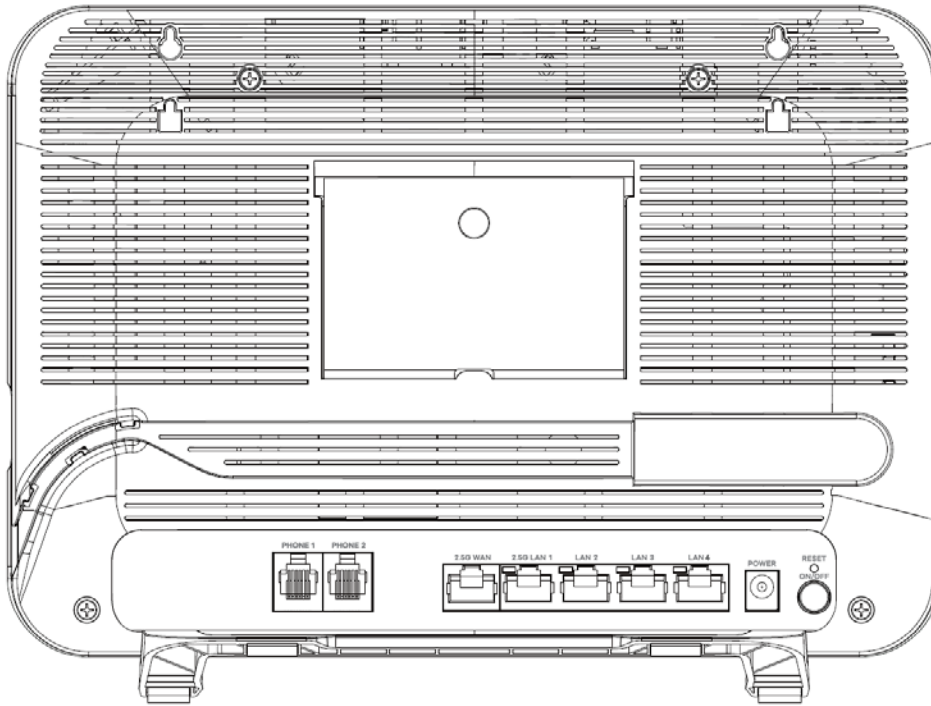
LABEL	DESCRIPTION
WAN	Use an Ethernet cable to connect the <b>WAN</b> port to a gateway/modem for Internet connection.
LAN1 – LAN3	Connect computers or other Ethernet devices to Ethernet ports for Internet access.
Phone1/2	Connect analog phones to the <b>PHONE</b> ports to make phone calls.
USB	The USB port is used for cellular WAN backup, file-sharing, and media server.
RESET	Press the button to return the Zyxel Device to the factory defaults.
POWER	Connect the power adapter and press the <b>ON/OFF</b> button to start the device.
WLAN	Press the <b>WLAN</b> button for more than 1 second to enable the WiFi function.
WPS	Press the <b>WPS</b> button once within 3 seconds to quickly setup a secure WiFi connection between the device and a WPS-compatible client.

### 2.3.5 EX5600-T1, EX5601-T0, and EX5601-T1

Figure 34 EX5600-T1

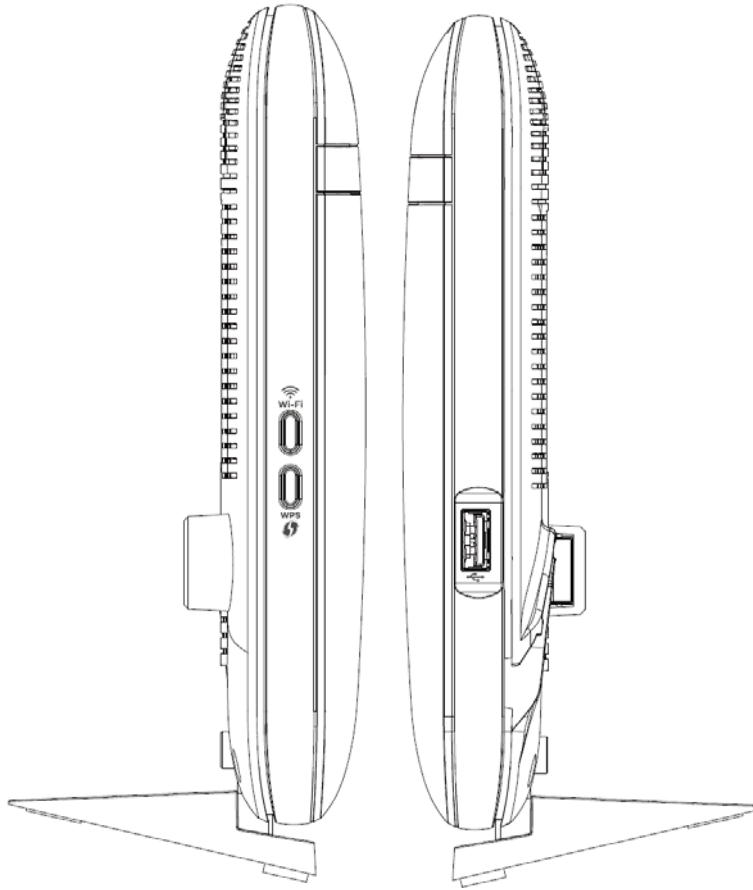


**Figure 35** EX5601-T0/EX5601-T1



Note: See [Section 1.1 on page 19](#) to see if your Zyxel Device supports the SFP port.

**Figure 36** EX5600-T1/EX5601-T0/EX5601-T1 Side Panels



The following table describes the items on the ports panels of EX5600-T1, EX5601-T0, and EX5601-T1.

Table 19 Panel Ports and Buttons

LABEL	DESCRIPTION
2.5G WAN	For EX5600-T1 and EX5601-T1, use an Ethernet cable to connect the 2.5G WAN port to a gateway/modem for an (up to) 2.5 Gbps Internet connection.  For EX5601-T0, use an Ethernet cable to connect the 2.5G WAN port to a gateway/modem, or connect a fiber optic/Ethernet cable to the SFP port through an SFP transceiver for an (up to) 2.5 Gbps Ethernet connection.
2.5G LAN1	Connect computers or other Ethernet devices to the 2.5G LAN port for Internet access with speed up to 2.5 Gbps.
LAN2-4	Connect computers or other Ethernet devices to Ethernet ports for Internet access.
SFP	For EX5601-T0, insert a compatible SFP transceiver to the SFP port and connect a fiber optic or Ethernet cable for an (up to) 2.5 Gbps Internet connection.
USB	The USB port is used for cellular WAN backup, file-sharing, and media server.
PHONE1/2	For EX5601-T0, and EX5601-T1, connect analog phones to the PHONE ports with RJ 11 cables for VoIP services.
RESET	Press the button for more than 5 seconds to return the Zyxel Device to the factory defaults.
POWER	Connect the power adapter and press the <b>ON/OFF</b> button to start the device.
WPS	Press the <b>WPS</b> button once within 3 seconds to quickly setup a secure WiFi connection between the device and a WPS-compatible client.
WiFi	Press the <b>WiFi</b> button for more than 2 seconds to enable the WiFi function.

## 2.3.6 EX7501-B0

Figure 37 Bottom Panel

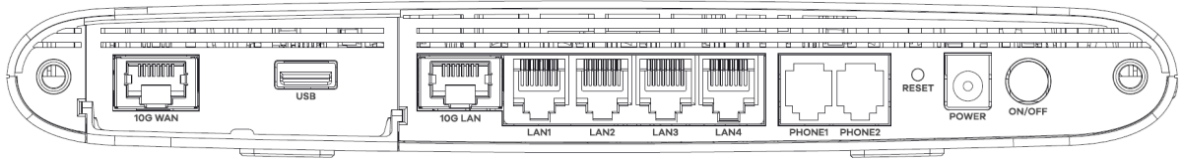
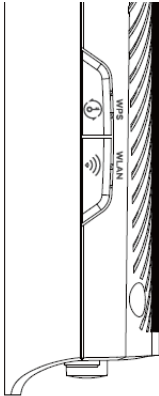


Figure 38 WPS/WLAN Buttons



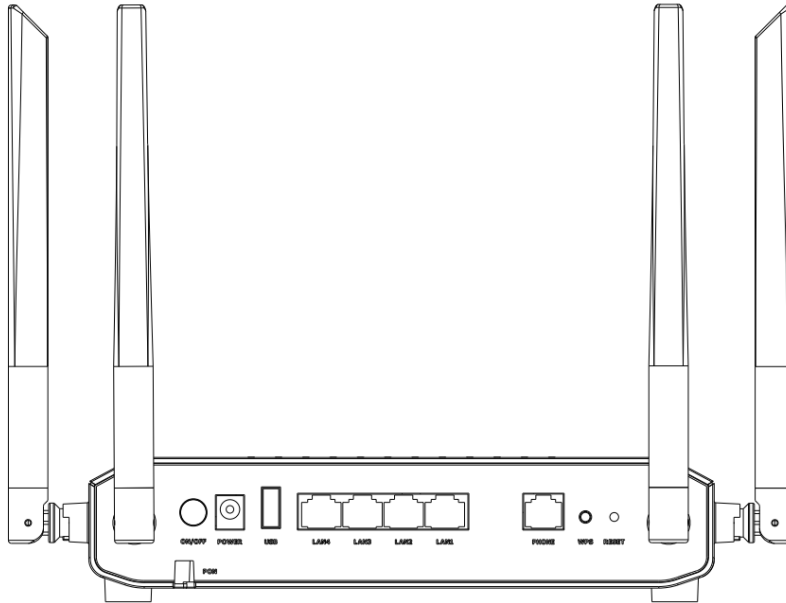
The following table describes the items on the ports panels of EX7501-B0.

Table 20 Panel Ports and Buttons

LABEL	DESCRIPTION
10G WAN	Connect an Ethernet cable to the <b>10G WAN</b> port for an (up to) 10 Gbps Ethernet connection.
10G LAN	Connect computers or other Ethernet devices to the <b>10G LAN</b> port for Internet access with speed up to 10 Gbps.
LAN1-4	Connect computers or other Ethernet devices to Ethernet ports for Internet access.
USB	The USB port is used for cellular WAN backup, file-sharing, and media server.
PHONE1/2	Connect analog phones to the <b>PHONE</b> ports with RJ 11 cables for VoIP services.
RESET	Press the button for more than 5 seconds to return the Zyxel Device to the factory defaults.
POWER	Connect the power adapter and press the <b>ON/OFF</b> button to start the device.
WPS	Press the <b>WPS</b> button once within 3 seconds to quickly setup a secure WiFi connection between the device and a WPS-compatible client.
WLAN	Press the <b>WLAN</b> button for more than 2 seconds to enable the WiFi function.

## 2.3.7 PX3321-T1

Figure 39 PX3321-T1



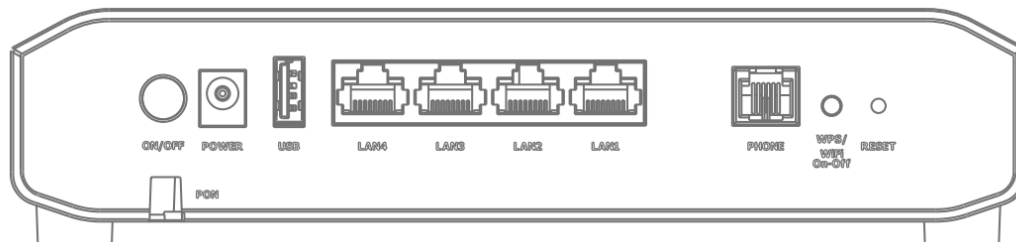
The following table describes the items on the ports panel of PX3321-T1.

Table 21 Panel Ports and Buttons

LABEL	DESCRIPTION
POWER	Connect the power adapter and press the <b>ON/OFF</b> button to start the device.
USB	The USB port is used for cellular WAN backup, file-sharing, and media server.
LAN 1-4	Connect computers or other Ethernet devices to Ethernet ports for Internet access.
Phone	Connect analog phone to the <b>PHONE</b> port with RJ11 cable for VoIP services.
WPS	Press the <b>WPS</b> button once within 3 seconds to quickly setup a secure WiFi connection between the device and a WPS-compatible client.
RESET	Press the button for more than 5 seconds to return the Zyxel Device to the factory defaults.

## 2.3.8 PX5531-T0

Figure 40 PX5531-T0



The following table describes the items on the ports panel of PX5531-T0.

Table 22 Panel Ports and Buttons

LABEL	DESCRIPTION
POWER	Connect the power adapter and press the <b>ON/OFF</b> button to start the device.
USB	The USB port is used for cellular WAN backup, file-sharing, and media server.
LAN 1-4	Connect computers or other Ethernet devices to Ethernet ports for Internet access.
Phone	Connect analog phone to the <b>PHONE</b> port with RJ11 cable for VoIP services.
WPS	Press the <b>WPS</b> button once within 3 seconds to quickly setup a secure WiFi connection between the device and a WPS-compatible client.
RESET	Press the button for more than 5 seconds to return the Zyxel Device to the factory defaults.

## 2.3.9 Transceiver Installation/Removal

### Transceiver Installation

Use the following steps to install an SFP transceiver.

- 1 Attach an ESD preventive wrist strap to your wrist and to a bare metal surface.
- 2 Align the transceiver in front of the slot opening.
- 3 Make sure the latch is in the lock position (latch styles vary), then insert the transceiver into the slot with the exposed section of PCB board facing down.
- 4 Press the transceiver firmly until it clicks into place.
- 5 The Zyxel Device automatically detects the installed transceiver. Check the LEDs to verify that it is functioning properly.
- 6 Remove the dust plugs from the transceiver and cables (dust plug styles vary).
- 7 Identify the signal transmission direction of the fiber cables and the transceiver. Insert the fiber cable into the transceiver.

Figure 41 Latch in the Lock Position

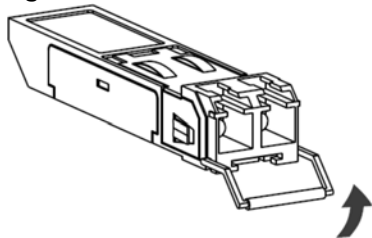
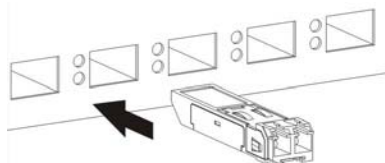
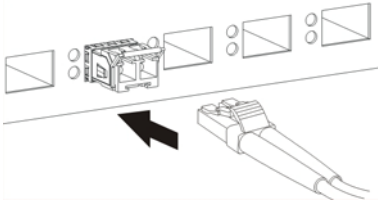


Figure 42 Transceiver Installation Example



**Figure 43** Connecting the Fiber Cables

## Transceiver Removal

Use the following steps to remove an SFP transceiver.

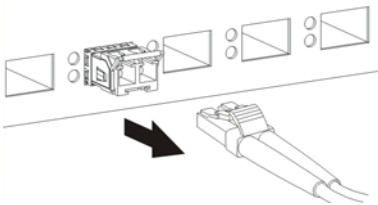
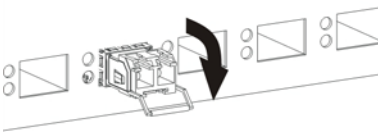
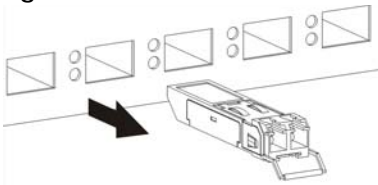
- 1 Attach an ESD preventive wrist strap to your wrist and to a bare metal surface on the chassis.
- 2 Remove the fiber cables from the transceiver.
- 3 Pull out the latch and down to unlock the transceiver (latch styles vary).

Note: Make sure the transceiver's latch is pushed all the way down, so the transceiver can be pulled out successfully.

- 4 Pull the latch, or use your thumb and index finger to grasp the tabs on both sides of the transceiver, and carefully slide it out of the slot.

Note: Do NOT pull the transceiver out by force. You could damage it. If the transceiver will not slide out, grasp the tabs on both sides of the transceiver with a slight up or down motion and carefully slide it out of the slot. If unsuccessful, contact Zyxel Support to prevent damage to your Zyxel Device and transceiver.

- 5 Insert the dust plug into the ports on the transceiver and the cables.

**Figure 44** Removing the Fiber Cables**Figure 45** Opening the Transceiver's Latch Example**Figure 46** Transceiver Removal Example

## 2.3.10 WPS Button

You can use the **WPS** button to quickly set up a secure WiFi connection between the Zyxel Device and a WPS-compatible client by adding one device at a time.

### To Activate WPS

- 1 Make sure the **POWER** LED is on and not blinking.
- 2 Press the **WPS** button once within 3 seconds (see the ports panel table of each Zyxel Device model in [Section 2.3 on page 50](#) for more information) and release it.
- 3 Press the **WPS** button on another WPS-enabled device within range of the Zyxel Device (within 120 seconds). The **WPS** LED flashes green while the Zyxel Device sets up a WPS connection with the other wireless device.
- 4 Once the connection is successfully made, the **WPS** LED will light off.

## 2.3.11 RESET Button

If you forget your password or cannot access the Web Configurator, you will need to use the **RESET** button to reload the factory-default configuration file. This means that you will lose all configurations that you had previously. The password will be reset to the factory default (see the device label), and the LAN IP address will be "192.168.1.1".

- 1 Make sure the **POWER** LED is on (not blinking).
- 2 To set the device back to the factory default settings, press the **RESET** button for more than 5 seconds or until the **POWER** LED begins to blink and then release it. When the **POWER** LED begins to blink, the defaults have been restored and the device restarts.



# CHAPTER 3

## Web Configurator

### 3.1 Overview

The Web Configurator is an HTML-based management interface that allows easy system setup and management through Internet browser. Use a browser that supports HTML5, such as Microsoft Edge, Mozilla Firefox, or Google Chrome. The recommended minimum screen resolution is 1024 by 768 pixels.

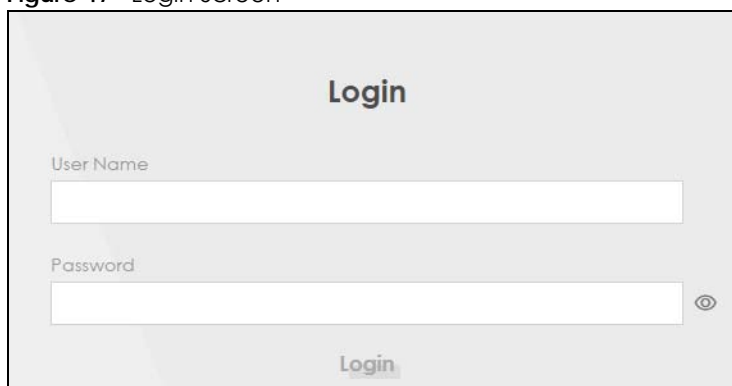
In order to use the Web Configurator you need to allow:

- Web browser pop-up windows from your computer.
- JavaScript (enabled by default).
- Java permissions (enabled by default).

#### 3.1.1 Access the Web Configurator

- 1 Make sure your Zyxel Device hardware is properly connected (refer to the Quick Start Guide).
- 2 Make sure your computer has an IP address in the same subnet as the Zyxel Device.
- 3 Launch your web browser. If the Zyxel Device does not automatically re-direct you to the login screen, go to <http://192.168.1.1>.
- 4 A login screen displays. Select the language you prefer (upper right).
- 5 To access the administrative Web Configurator and manage the Zyxel Device, enter the default user name **admin** and the randomly assigned default password (see the Zyxel Device label) in the **Login** screen and click **Login**. If you have changed the password, enter your password and click **Login**.

**Figure 47** Login Screen



The image shows a web browser window displaying the login page of a Zyxel device. The page has a light gray background. At the top center, the word "Login" is displayed in a bold, dark font. Below this, there are two input fields. The first is labeled "User Name" and is a simple white rectangular box. The second is labeled "Password" and is a white rectangular box with a small eye icon to its right, used for toggling password visibility. At the bottom center of the form area, there is a "Login" button.

Note: The first time you enter the password, you will be asked to change it. Make sure the new password must contain at least one uppercase letter, one lowercase letter and one number. For some models, the password must contain at least one English character and one number. Please see the password requirement displayed on the screen.

- 6 The **Connection Status** screen appears. Use this screen to configure basic Internet access and WiFi settings.

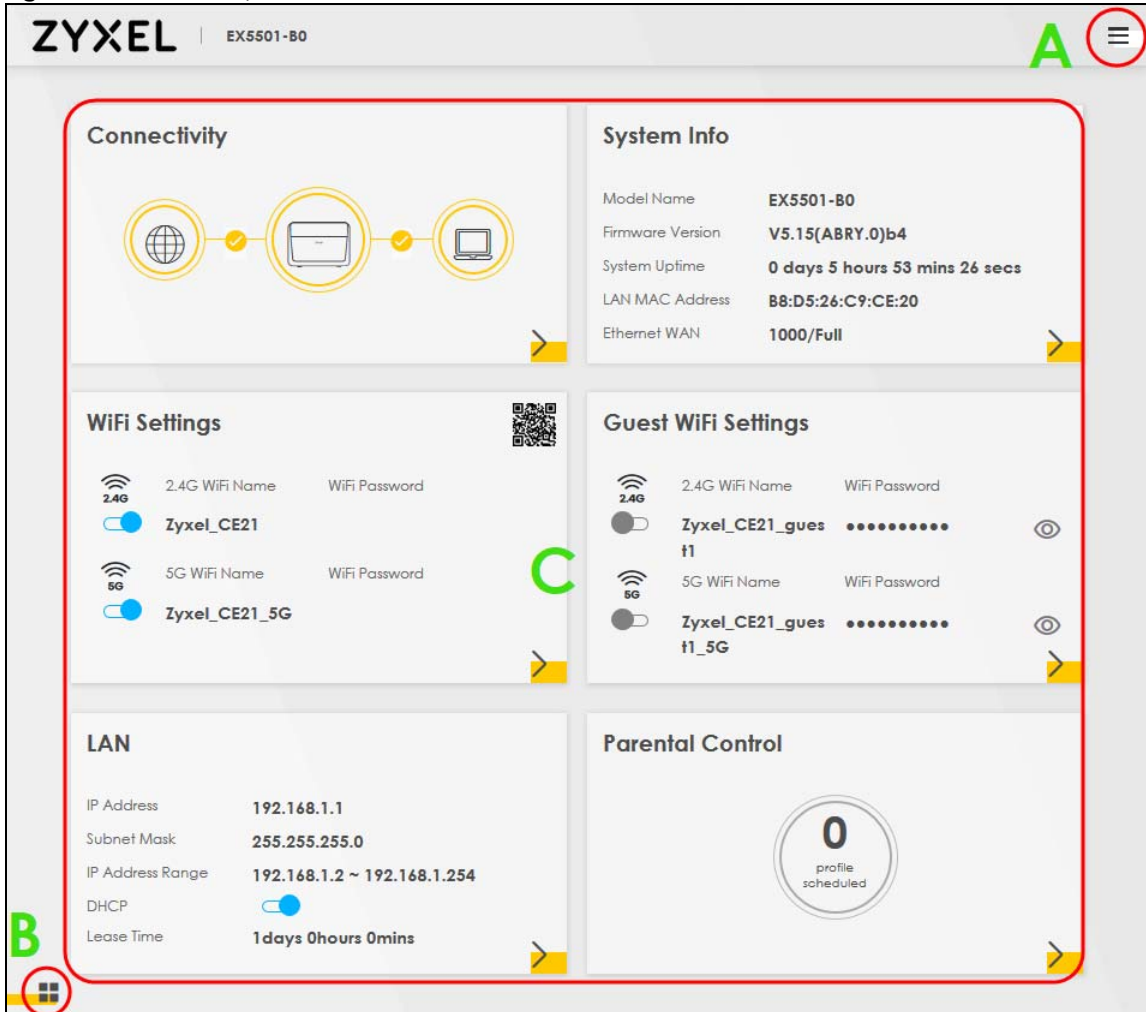
**Figure 48** Connection Status

The screenshot displays the 'Connection Status' web configurator interface, organized into six main sections:

- Connectivity:** Shows a status diagram with three icons (globe, laptop, tablet) connected by lines, indicating network connectivity. A yellow arrow points to the right.
- System Info:** Lists system details:
  - Model Name: **EX5501-B0**
  - Firmware Version: **V5.15(ABRY.0)b4**
  - System Uptime: **0 days 5 hours 50 mins 18 secs**
  - LAN MAC Address: **B8:D5:26:C9:CE:20**
  - Ethernet WAN: **1000/Full**
 A yellow arrow points to the right.
- WiFi Settings:** Includes a QR code and two rows of settings:
  - 2.4G:** 2.4G WiFi Name: **Zyxel\_CE21**, WiFi Password: [redacted]
  - 5G:** 5G WiFi Name: **Zyxel\_CE21\_5G**, WiFi Password: [redacted]
 A yellow arrow points to the right.
- Guest WiFi Settings:** Includes two rows of settings:
  - 2.4G:** 2.4G WiFi Name: **Zyxel\_CE21\_gues t1**, WiFi Password: [redacted]
  - 5G:** 5G WiFi Name: **Zyxel\_CE21\_gues t1\_5G**, WiFi Password: [redacted]
 A yellow arrow points to the right.
- LAN:** Lists network parameters:
  - IP Address: **192.168.1.1**
  - Subnet Mask: **255.255.255.0**
  - IP Address Range: **192.168.1.2 ~ 192.168.1.254**
  - DHCP:
  - Lease Time: **1 days 0 hours 0 mins**
 A yellow arrow points to the right.
- Parental Control:** Shows a large '0' in a circle with the text 'profile scheduled' below it. A yellow arrow points to the right.

## 3.2 Web Configurator Layout

Figure 49 Screen Layout



As illustrated above, the main screen is divided into these parts:

- A – Settings Icon (Navigation Panel and Side Bar)
- B – Layout Icon
- C – Main Window

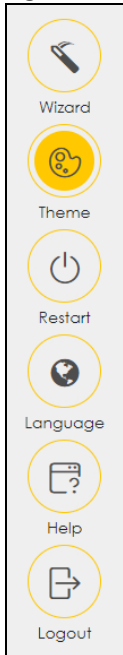
### 3.2.1 Settings Icon

Click this icon (☰) to see the side bar and navigation panel.

#### 3.2.1.1 Side Bar

The side bar provides some icons on the right hand side.

**Figure 50** Side Bar



The icons provide the following functions.

**Table 23** Web Configurator Icons in the Title Bar



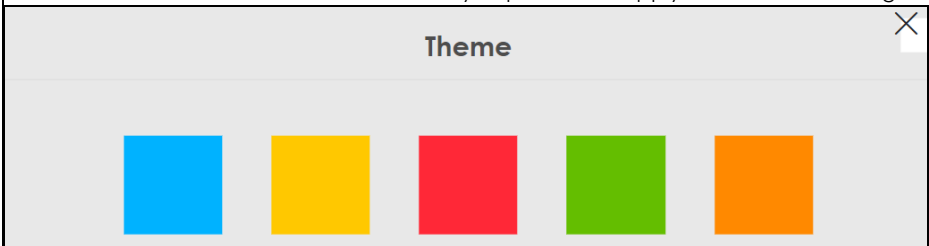



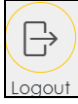

ICON	DESCRIPTION
 <p>Wizard</p>	<p><b>Wizard:</b> Click this icon to open screens where you can configure the Zyxel Device's time zone and WiFi settings.</p>
 <p>Theme</p>	<p><b>Theme:</b> Click this icon to select a color that you prefer and apply it to the Web Configurator.</p> 
 <p>Language</p>	<p><b>Language:</b> Select the language you prefer.</p>
 <p>Help</p>	<p><b>Help:</b> Click this link to display web help pages. The help pages provide descriptions for all of the configuration screens.</p>

Table 23 Web Configurator Icons in the Title Bar (continued)

ICON	DESCRIPTION
	<b>Restart:</b> Click this icon to reboot the Zyxel Device without turning the power off.
	<b>Logout:</b> Click this icon to log out of the Web Configurator.

### 3.2.1.2 Navigation Panel

Click the menu icon () to display the navigation panel that contains configuration menus and icons (quick links). Click **X** to close the navigation panel.

Use the menu items on the navigation panel to open screens to configure Zyxel Device features. The following tables describe each menu item.

Figure 51 Navigation Panel

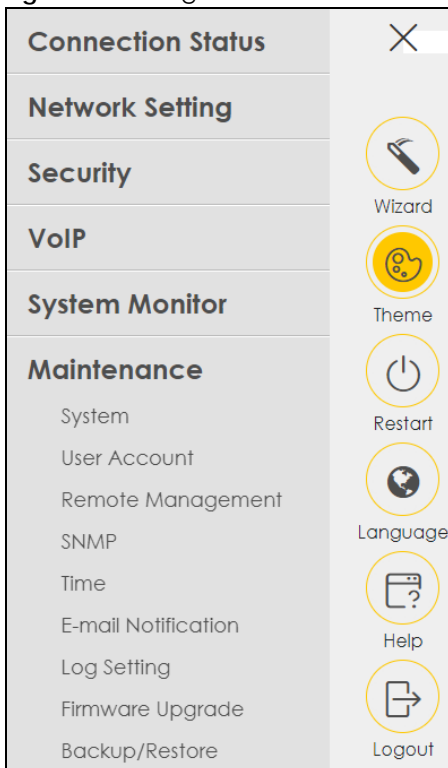


Table 24 Navigation Panel Summary

LINK	TAB	FUNCTION
Connection Status		Use this screen to configure basic Internet access, wireless settings, and parental control settings. This screen also shows the network status of the Zyxel Device and computers/devices connected to it.
Network Setting		
Broadband	Broadband	Use this screen to view and configure ISP parameters, WAN IP address assignment, and other advanced properties. You can also add new WAN connections.

Table 24 Navigation Panel Summary (continued)

LINK	TAB	FUNCTION
	Cellular Backup	Use this screen to configure a cellular WAN connection as a backup to keep you online if the primary WAN connection fails.
	Advanced	Use this screen to enable or disable PTM over ADSL, Annex M/Annex J, and DSL PhyR functions.
	Backup WAN	Use this screen to convert the LAN port as a WAN port, or reset the WAN port to LAN port.
Wireless	General	Use this screen to configure the WiFi settings and WiFi authentication or security settings.
	Guest/More AP	Use this screen to configure multiple BSSs on the Zyxel Device.
	MAC Authentication	Use this screen to block or allow wireless traffic from wireless devices of certain SSIDs and MAC addresses to the Zyxel Device.
	WPS	Use this screen to configure and view your WPS (WiFi Protected Setup) settings.
	WMM	Use this screen to enable or disable WiFi MultiMedia (WMM).
	Others	Use this screen to configure advanced WiFi settings.
	Channel Status	Use this screen to scan WiFi channel noises and view the results.
	MESH	Use this screen to enable or disable MPro Mesh.
Home Networking	LAN Setup	Use this screen to configure LAN TCP/IP settings, and other advanced properties.
	Static DHCP	Use this screen to assign specific IP addresses to individual MAC addresses.
	UPnP	Use this screen to turn UPnP and UPnP NAT-T on or off.
	Additional Subnet	Use this screen to configure IP alias and public static IP.
	STB Vendor ID	Use this screen to configure the Vendor IDs of the connected Set Top Box (STB) devices, which have the Zyxel Device automatically create static DHCP entries for the STB devices when they request IP addresses.
	Wake on LAN	Use this screen to remotely turn on a device on the local network.
	TFTP Server Name	Use DHCP option 66 to identify a TFTP server name.
	APAS	Use this screen to allow a LAN device to use any available port to access any available service from a remote WAN device.
Routing	Static Route	Use this screen to view and set up static routes on the Zyxel Device.
	DNS Route	Use this screen to forward DNS queries for certain domain names through a specific WAN interface to its DNS servers.
	Policy Route	Use this screen to configure policy routing on the Zyxel Device.
	RIP	Use this screen to configure Routing Information Protocol to exchange routing information with other routers.
QoS	General	Use this screen to enable QoS and traffic prioritizing. You can also configure the QoS rules and actions.
	Queue Setup	Use this screen to configure QoS queues.
	Classification Setup	Use this screen to define a classifier.
	Shaper Setup	Use this screen to limit outgoing traffic rate on the selected interface.
	Policer Setup	Use this screen to configure QoS policers.
	Monitor	Use this screen to view statistics of QoS on WAN/LAN interface and the status of queues.
NAT	Port Forwarding	Use this screen to make your local servers visible to the outside world.

Table 24 Navigation Panel Summary (continued)

LINK	TAB	FUNCTION
	Port Triggering	Use this screen to change your Zyxel Device's port triggering settings.
	DMZ	Use this screen to configure a default server which receives packets from ports that are not specified in the <b>Port Forwarding</b> screen.
	ALG	Use this screen to enable the ALGs (Application Layer Gateways) in the Zyxel Device to allow applications to operate through NAT.
	Address Mapping	Use this screen to change your Zyxel Device's IP address mapping settings.
	Sessions	Use this screen to configure the maximum number of NAT sessions each client host is allowed to have through the Zyxel Device.
	PCP	Use this screen to configure PCP (Port Control Protocol) to allow devices such as web or file sharing servers behind the Zyxel Device to receive incoming traffic.
DNS	DNS Entry	Use this screen to view and configure DNS routes.
	Dynamic DNS	Use this screen to allow a static hostname alias for a dynamic IP address.
IGMP/MLD	IGMP/MLD	Use this screen to configure multicast settings (IGMP for IPv4 and MLD for IPv6 multicast groups) on the WAN.
VLAN Group	VLAN Group	Use this screen to group and tag VLAN IDs to outgoing traffic from the specified interface.
Interface Grouping	Interface Grouping	Use this screen to map a port to create multiple networks on the Zyxel Device.
USB Service	File Sharing	Use this screen to enable file sharing through the Zyxel Device.
	Media Server	Use this screen to use the Zyxel Device as a media server.
Security		
Firewall	General	Use this screen to configure the security level of your firewall.
	Protocol	Use this screen to add Internet services and configure firewall rules.
	Access Control	Use this screen to enable specific traffic directions for network services.
	DoS	Use this screen to activate protection against Denial of Service (DoS) attacks.
MAC Filter	MAC Filter	Use this screen to block or allow traffic from devices of certain MAC addresses to the Zyxel Device.
Home Security	Connected Home Security	Use this screen to set up a URL filter that blocks users on your network from accessing certain websites.
Parental Control	Parental Control	Use this screen to define time periods and days during which the Zyxel Device performs parental control and/or block web sites with the specific URL.
Scheduler Rule	Scheduler Rule	Use this screen to configure the days and times when a configured restriction (such as parental control) is enforced.
Certificates	Local Certificates	Use this screen to view a summary list of certificates and manage certificates and certification requests.
	Trusted CA	Use this screen to view and manage the list of the trusted CAs.
VoIP		
SIP	SIP Account	Use this screen to set up information about your SIP account and configure audio settings such as volume levels for the phones connected to the Zyxel Device.
	SIP Service Provider	Use this screen to configure the SIP server information, and other SIP settings, such as QoS for VoIP calls, outbound proxy, DTMF mode and SIP timers.

Table 24 Navigation Panel Summary (continued)

LINK	TAB	FUNCTION
	SIP TLS Common	Use this screen to change the default TLS local port if you need to, and select a local certificate for the SIP server to verify the Zyxel Device.
Phone	Phone Device	Use this screen to control which SIP accounts each phone uses to handle outgoing and incoming calls.
	Region	Use this screen to select your location and call service mode.
Call Rule	Call Rule	Use this screen to configure speed dial for SIP phone numbers that you often call.
Call History	Call History	Use this screen to view detailed information for each outgoing call you made or each incoming call from someone calling you. You can also view a summary list of received, dialed and missed calls.
System Monitor		
Log	System Log	Use this screen to view the status of events that occurred to the Zyxel Device. You can export or email the logs.
	Security Log	Use this screen to view all security related events. You can select the level and category of the security events in their proper drop-down list window.  Levels include: <ul style="list-style-type: none"> <li>• Emergency</li> <li>• Alert</li> <li>• Critical</li> <li>• Error</li> <li>• Warning</li> <li>• Notice</li> <li>• Informational</li> <li>• Debugging</li> </ul> Categories include: <ul style="list-style-type: none"> <li>• Account</li> <li>• Attack</li> <li>• Firewall</li> <li>• MAC Filter</li> </ul>
Traffic Status	WAN	Use this screen to view the status of all network traffic going through the WAN port of the Zyxel Device.
	LAN	Use this screen to view the status of all network traffic going through the LAN ports of the Zyxel Device.
	NAT	Use this screen to view NAT statistics for connected hosts.
VoIP Status	VoIP Status	Use this screen to view VoIP registration, current call status and phone numbers for the phone ports.
ARP Table	ARP Table	Use this screen to view the ARP table. It displays the IP and MAC address of each DHCP connection.
Routing Table	Routing Table	Use this screen to view the routing table on the Zyxel Device.
Multicast Status	IGMP Status	Use this screen to view the status of all IGMP settings on the Zyxel Device.
	MLD Status	Use this screen to view the status of all MLD settings on the Zyxel Device.
xDSL Statistics	xDSL Statistics	Use this screen to view the Zyxel Device's xDSL traffic statistics.
WLAN Station Status	WLAN Station Status	Use this screen to view the wireless stations that are currently associated to the Zyxel Device's WiFi.
Cellular Statistics	Cellular Statistics	Use this screen to look at the cellular Internet connection status.



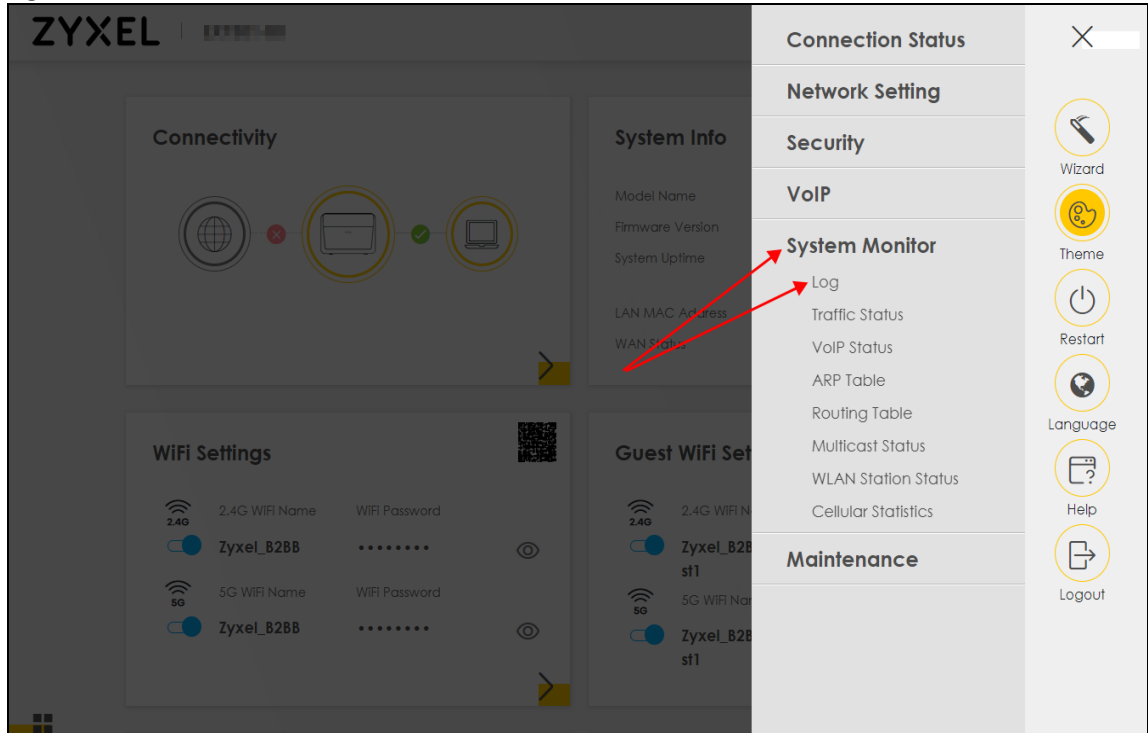
Table 24 Navigation Panel Summary (continued)

LINK	TAB	FUNCTION
GPON Status	GPON Status	Use this screen to view the fiber transceiver's TX power and RX power level and its temperature.  Note: Not yet available as of this writing.
Maintenance		
System	System	Use this screen to set the Zyxel Device name and Domain name.
User Account	User Account	Use this screen to change the user password on the Zyxel Device.
Remote Management	MGMT Services	Use this screen to enable specific traffic directions for network services.
	Trust Domain	Use this screen to view a list of public IP addresses which are allowed to access the Zyxel Device through the services configured in the <b>Maintenance &gt; Remote Management</b> screen.
SNMP	SNMP	Use this screen to configure SNMP (Simple Network Management Protocol) settings.
Time	Time	Use this screen to change your Zyxel Device's time and date.
E-mail Notification	E-mail Notification	Use this screen to configure up to two mail servers and sender addresses on the Zyxel Device.
Log Settings	Log Settings	Use this screen to change your Zyxel Device's log settings.
Firmware Upgrade	Firmware Upgrade	Use this screen to upload firmware to your Zyxel Device.
Backup/Restore	Backup/Restore	Use this screen to backup and restore your Zyxel Device's configuration (settings) or reset the factory default settings.
Reboot	Reboot	Use this screen to reboot the Zyxel Device without turning the power off.
Diagnostic	Ping&Traceroute &Nslookup	Use this screen to identify problems with the Zyxel Device. You can use Ping, TraceRoute, or Nslookup to help you identify problems.
	802.1ag	Use this screen to configure CFM (Connectivity Fault Management) MD (maintenance domain) and MA (maintenance association), perform connectivity tests and view test reports.
	802.3ah	Use this screen to configure link OAM port parameters,
	OAM Ping	Use this screen to view information to help you identify problems with the DSL connection.

### 3.2.1.3 Dashboard

Use the menu items in the navigation panel on the right to open screens to configure the Zyxel Device's features.

Figure 52 Navigation Panel



### 3.2.2 Widget Icon


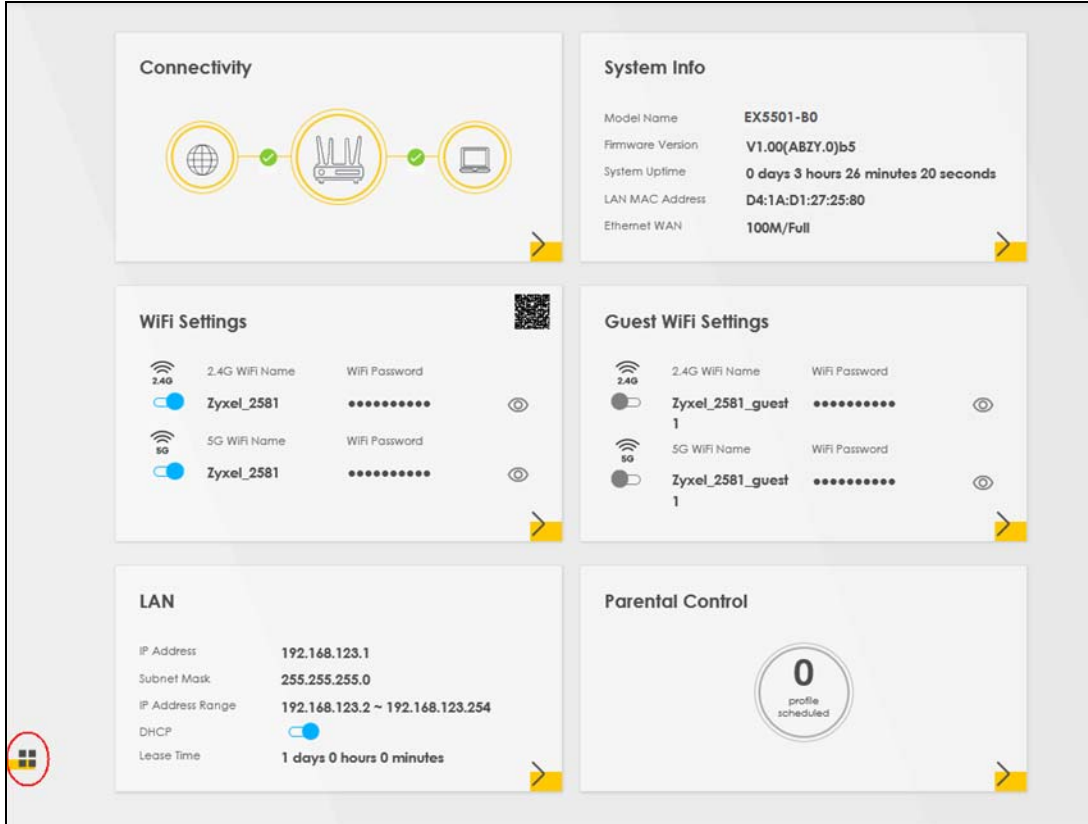
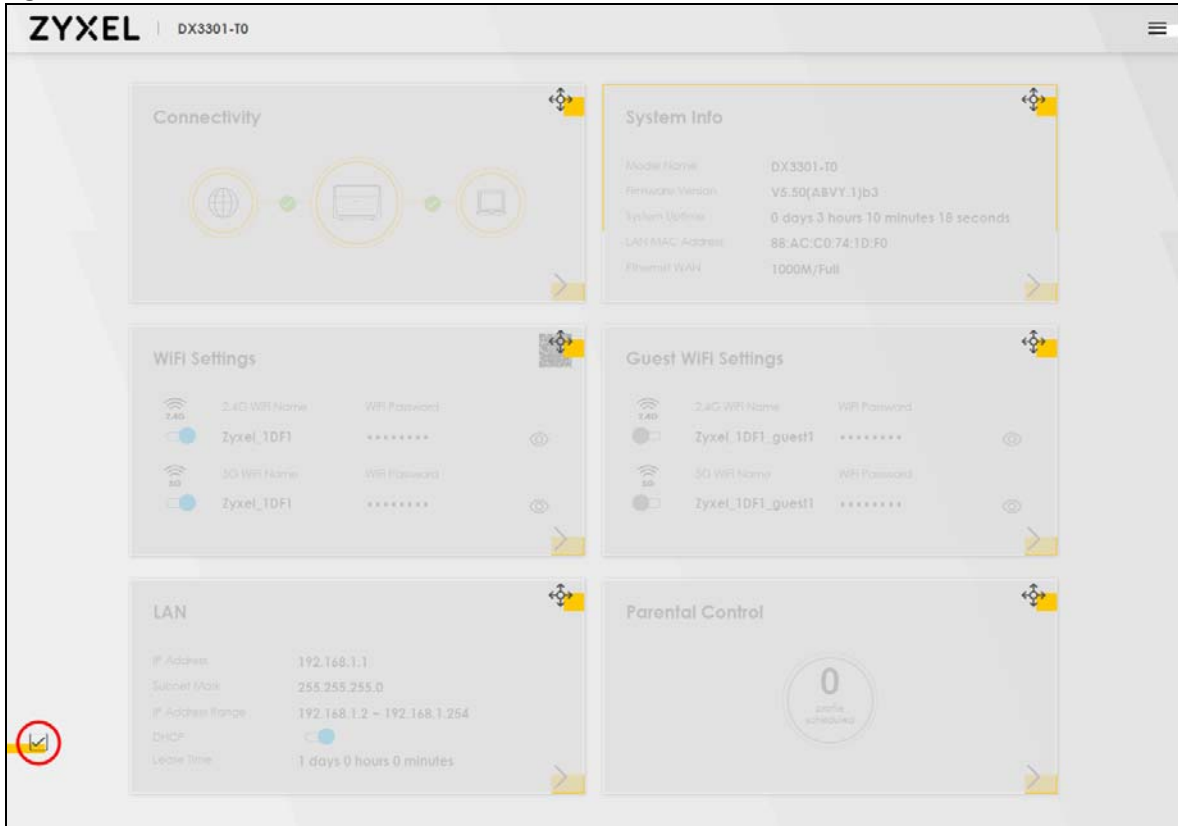
Click the Widget icon (  ) in the lower left corner to arrange the screen order.

Figure 53 Dashboard Widget



The following screen appears. Select a block and hold it to move around. Click the Check icon (☑) in the lower left corner to save the changes.

Figure 54 Check Icon



# CHAPTER 4

## Quick Start

### 4.1 Quick Start Overview

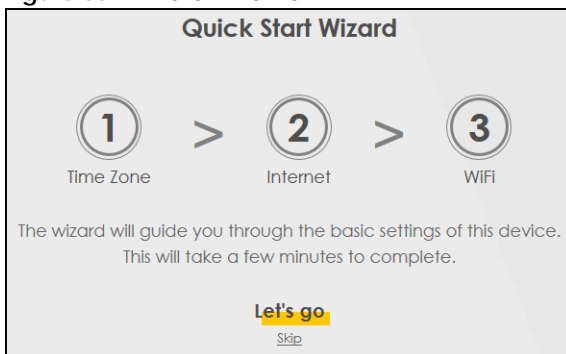
Use the **Wizard** screens to configure the Zyxel Device's time zone and WiFi settings.

Note: See the technical reference chapters for background information on the features in this chapter.

### 4.2 Quick Start Setup

You can click the **Wizard** icon in the side bar to open the **Wizard** screens. After you click the **Wizard** icon, the following screen appears. Click **Let's go** to proceed with settings on time zone and WiFi networks. It will take you a few minutes to complete the settings on the **Wizard** screens. You can click **Skip** to leave the **Wizard** screens.

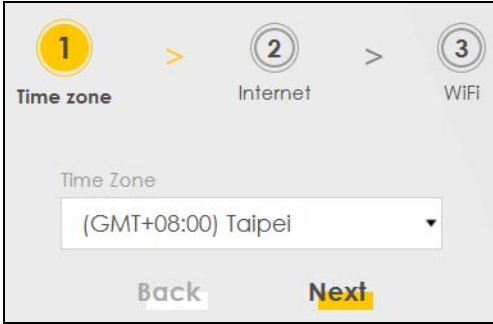
Figure 55 Wizard – Home



### 4.3 Quick Start Setup – Time Zone

Select the time zone of the Zyxel Device's location. Click **Next**.

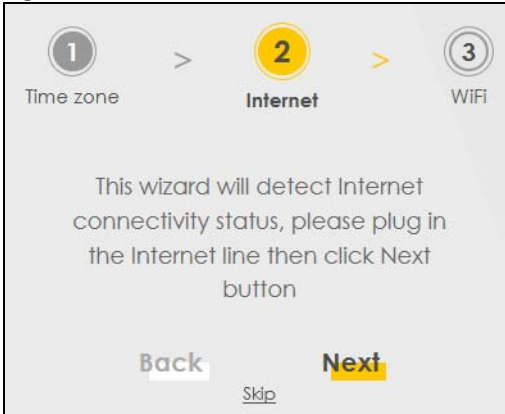
Figure 56 Wizard – Time Zone



## 4.4 Quick Start Setup – Internet Connection

The Zyxel Device detects your Internet connection status. Click **Next** to continue.

Figure 57 Wizard – Internet



### 4.4.1 Successful Internet Connection

The Zyxel Device has Internet access.

Figure 58 Wizard – Successful Internet Connection



## 4.4.2 Unsuccessful Internet Connection

The Zyxel Device did not detect a WAN connection. See [Section 4.5.4 on page 509](#) for troubleshooting the Zyxel Device WAN connection.

**Figure 59** Wizard – Internet Connection is Down



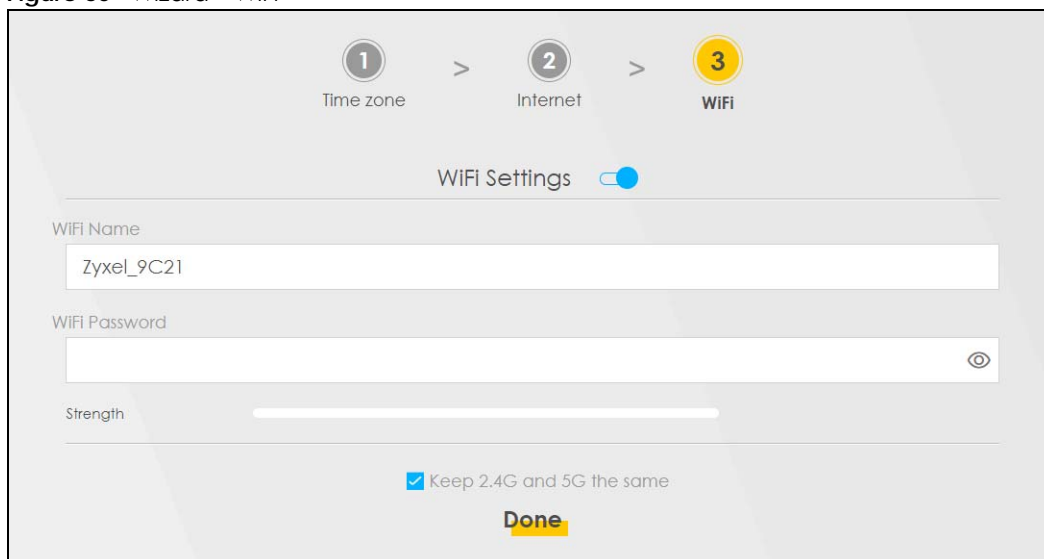
## 4.5 Quick Start Setup – WiFi

Turn WiFi on or off. If you keep it on, record the **WiFi Name** and **Password** in this screen so you can configure your WiFi clients to connect to the Zyxel Device. If you want to show or hide your WiFi password, click the Eye icon (👁).

Select **Keep 2.4G and 5G the same** to use the same SSID for 2.4G and 5G WiFi networks. Otherwise, clear the check box to have two different SSIDs for 2.4G and 5G WiFi networks. The screen and fields to enter may vary when you select or clear the check box.

You have to disable **MPro Mesh** in the **Network > Wireless > MESH** screen to clear the **Keep 2.4G and 5G the same** check box. Click **Done**.

**Figure 60** Wizard – WiFi



## 4.6 Quick Start Setup – Finish

Your Zyxel Device saves and applies your settings.



# CHAPTER 5

## Web Interface Tutorials

### 5.1 Web Interface Overview

This chapter shows you how to use the Zyxel Device's various features.

- [Wired Network Setup](#)
- [WiFi Network Setup](#)
- [USB Applications](#)
- [Network Security](#)
- [Internet Calls](#)
- [Device Maintenance](#)

### 5.2 Wired Network Setup

This section shows you how to set up a DSL or Ethernet Internet connection with the **Broadband** screens. The screens vary by the connection mode, encapsulation type and IP mode (IPv6 or IPv4) you select.

Set the Zyxel Device to **Routing** mode or **Bridge** mode on this connection as follows:

- Use **Routing** mode if you want the Zyxel Device to use routing mode functions such as **NAT**, **Firewall**, or **DHCP Server**. You will need to reconfigure your network if you have an existing router.
- Use **Bridge** mode to pass the ISP-assigned IP address(es) to your devices connected to the LAN port. All traffic from the Internet passes through the Zyxel Device directly to devices connected to the LAN port. Use this mode if you already have a router with complete routing functions in your network.

#### 5.2.1 Setting Up a DSL Connection

This tutorial shows you how to set up a DSL Internet connection using the Web Configurator on DSL routers (see [Section 1.1 on page 19](#)).

If you connect to the Internet through a DSL connection, use the information from your Internet Service Provider (ISP) to configure the **Broadband** screens.

- 1 Go to **Network Setting > Broadband** and then the following screen appears. Click **Add New WAN Interface**.

**Broadband**

**Broadband** Cellular Backup Advanced

You can configure the Internet settings of this device. Correct configurations build successful Internet connection.

+ Add New WAN Interface

#	Name	Type	Mode	Encapsulation	802.1p	802.1q	IGMP Proxy	NAT	Default Gateway	IPv6	MLD Proxy	Modify
1	ADSL	ATM	Routing	IPoE	N/A	N/A	Y	Y	Y	Y	Y	
2	VDSL	PTM	Routing	IPoE	N/A	N/A	Y	Y	Y	Y	Y	
3	ETHWAN	ETH	Routing	IPoE	N/A	N/A	Y	Y	Y	Y	Y	

- 2 To set the Zyxel Device to **Routing** mode, see [Section 1 on page 82](#).

To set the Zyxel Device to **Bridge** mode, see [Section 1 on page 85](#).

## Routing Mode

- 1 In this routing mode example, the DSL WAN connection has the following information.

General	
Name	MyDSLConnection
Type	ADSL over ATM
Connection Mode	Routing
Encapsulation	PPPoE
IPv6/IPv4 Mode	IPv4
ATM PVC Configuration	
VPI/VCI	36/48
Encapsulation Mode	LLC/SNAP-Bridging
Service Category	UBR without PCR
Account Information	
PPP User Name	1234@DSL-Ex.com
PPP Password	ABCDEF!
Static IP Address	192.168.1.32
Gateway IP Address	192.168.1.254
Primary DNS server	192.168.5.2

Secondary DNS server	192.168.5.1
Others	Authentication Method: AUTO PPPoE Passthrough: Disabled NAT: Enabled IGMP Multicast Proxy: Enabled Apply as Default Gateway: Enabled VLAN: Disabled

- 2 Enter the **General** and **ATM PVC Configuration** settings as provided above.
  - Set the **Type** to **ADSL over ATM**.
  - Choose the **Encapsulation** specified by your DSL service provider. For this example, the service provider requires a username and password to establish an Internet connection. Therefore, select **PPPoE** as the WAN encapsulation type.
  - Set the **IPv4/IPv6 Mode** to **IPv4 Only**.
- 3 Enter the account information provided by your DSL service provider.
- 4 Enable **Apply as Default Gateway** to use this rule as your default Internet connection. Then select **Use Following Static DNS Address** and enter the DNS server addresses provided by your DSL service provider.
- 5 For the rest of the fields, use the default settings.
- 6 Click **Apply** to save your settings.

<
**Add New WAN Interface**

<div style="text-align: center; border-bottom: 1px solid black; margin-bottom: 10px;"><b>General</b> <input checked="" type="checkbox"/></div> <p>Name: <input type="text" value="MyDSL Connect"/></p> <p>Type: <input type="text" value="ADSL over ATM"/></p> <p>Mode: <input type="text" value="Routing"/></p> <p>Encapsulation: <input type="text" value="PPPoE"/></p> <p>IPv4/IPv6 Mode: <input type="text" value="IPv4 Only"/></p>	<div style="text-align: center; border-bottom: 1px solid black; margin-bottom: 10px;"><b>PPP Information</b></div> <p>PPP User Name: <input type="text" value="admin"/></p> <p>PPP Password: <input type="password" value="****"/> <input type="checkbox"/></p> <p>PPP Connection Trigger: <input checked="" type="radio"/> Auto Connect <input type="radio"/> On Demand</p> <p>PPPoE Passthrough: <input type="checkbox"/></p>
<div style="text-align: center; border-bottom: 1px solid black; margin-bottom: 10px;"><b>ATM PVC Configuration</b></div> <p>VPI [0-255]: <input type="text" value="0"/></p> <p>VCI [32-65535]: <input type="text" value="33"/></p> <p>Encapsulation: <input type="text" value="LLC/SNAP-BRIDGING"/></p> <p>Service Category: <input type="text" value="UBR Without PCR"/></p>	<div style="text-align: center; border-bottom: 1px solid black; margin-bottom: 10px;"><b>VLAN</b> <input type="checkbox"/></div> <p>802.1p: <input type="text" value="0"/></p> <p>802.1q: <input type="text" value=""/> (1~4094)</p> <div style="text-align: center; border-bottom: 1px solid black; margin-bottom: 10px;"><b>MTU</b></div> <p>MTU: <input type="text" value="1500"/></p>
<div style="text-align: center; border-bottom: 1px solid black; margin-bottom: 10px;"><b>IP Address</b></div> <p><input type="radio"/> Obtain an IP Address Automatically</p> <p><input checked="" type="radio"/> Static IP Address</p> <p>IP Address: <input type="text" value="."/> . <input type="text" value="."/> . <input type="text" value="."/></p> <div style="text-align: center; border-bottom: 1px solid black; margin-bottom: 10px;"><b>DNS Server</b></div> <p><input type="radio"/> Obtain DNS Info Automatically</p> <p><input checked="" type="radio"/> Use Following Static DNS Address:</p> <p>Primary DNS Server: <input type="text" value="."/> . <input type="text" value="."/> . <input type="text" value="."/></p> <p>Secondary DNS Server: <input type="text" value="."/> . <input type="text" value="."/> . <input type="text" value="."/></p>	<div style="text-align: center; border-bottom: 1px solid black; margin-bottom: 10px;"><b>Routing Feature</b></div> <p>NAT: <input checked="" type="checkbox"/> <b>IGMP Proxy</b>: <input checked="" type="checkbox"/></p> <p>Apply as Default Gateway: <input type="checkbox"/> <b>Fullcone NAT</b>: <input type="checkbox"/></p> <p>6RD: <input type="checkbox"/></p>

Cancel
Apply









- 7 Try to connect to a website to see if you have correctly set up your Internet connection.

**Broadband**

**Broadband** Cellular Backup Advanced

You can configure the Internet settings of this device. Correct configurations build successful Internet connection.

+ Add New WAN Interface

#	Name	Type	Mode	Encapsulation	802.1p	802.1q	IGMP Proxy	NAT	Default Gateway	IPv6	MLD Proxy	Modify
1	ADSL	ATM	Routing	IPoE	N/A	N/A	Y	Y	Y	Y	Y	 
2	VDSL	PTM	Routing	IPoE	N/A	N/A	Y	Y	Y	Y	Y	 
3	ETHWAN	ETH	Routing	IPoE	N/A	N/A	Y	Y	Y	Y	Y	 
4	MyDSLConnection	ATM	Routing	PPPoE	N/A	N/A	Y	Y	Y	N	N	 

The new connection is displayed on the **Broadband** screen.

## Bridge Mode

- 1 In this bridge mode example, the DSL WAN connection has the following information.

General	
Name	MyDSLConnection
Type	ADSL over ATM
Connection Mode	Bridge
ATM PVC Configuration	
VPI/VCI	36/48
Encapsulation Mode	LLC/SNAP-BRIDGING
Service Category	UBR without PCR

- 2 Enter the **General** and **ATM PVC Configuration** settings as provided above.
- 3 For the rest of the fields, use the default settings.
- 4 Click **Apply** to save your settings.

**Edit WAN Interface**

**General**

Name: MyDSL Connect

Type: ADSL over ATM

Mode: Bridge

**ATM PVC Configuration**

VPI [0-255]: 36

VCI [32-65535]: 48

Encapsulation: LLC/SNAP-BRIDGING

Service Category: UBR Without PCR

**VLAN**

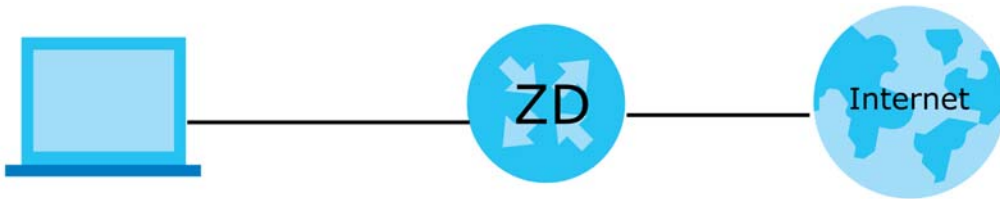
802.1p: 0

802.1q: (1~4094)

Cancel **Apply**

## 5.2.2 Setting Up an Ethernet Connection

If you connect to the Internet through an Ethernet connection, you need to connect a broadband modem or router with Internet access to the WAN Ethernet port on the Zyxel Device. You need to configure the Internet settings from the broadband modem or router on the Zyxel Device. First, make sure you have Internet access through the broadband modem or router by connecting directly to it.



This example shows you how to configure an Ethernet WAN connection.

- 1 Make sure you have the Ethernet WAN port connect to a modem or router.
- 2 Go to **Network Setting > Broadband** and then the following screen appears. Click **Add New WAN Interface** to add a WAN connection.

#	Name	Type	Mode	Encapsulation	802.1p	802.1q	IGMP Proxy	NAT	Default Gateway	IPv6	MLD Proxy	Modify
1	ADSL	ATM	Routing	IPoE	N/A	N/A	Y	Y	Y	Y	Y	
2	VDSL	PTM	Routing	IPoE	N/A	N/A	Y	Y	Y	Y	Y	
3	ETHWAN	ETH	Routing	IPoE	N/A	N/A	Y	Y	Y	Y	Y	

- 3 To set the ZyXel Device to **Routing** mode, see [Section 1 on page 87](#).

To set the ZyXel Device to **Bridge** mode, see [Section 1 on page 88](#).

## Routing Mode

- 1 In this routing mode example, configure the following information for the Ethernet WAN connection.

General	
Name	My ETH Connection
Type	Ethernet
Connection Mode	Routing
Encapsulation (Internet Type)	IPoE
IPv6/IPv4 Mode	IPv4 Only

- 2 Enter the **General** settings provided by your Internet service provider.
- Enter a **Name** to identify your WAN connection.
  - Set the **Type** to **Ethernet**.
  - Set your Ethernet connection **Mode** to **Routing**.
  - Choose the **Encapsulation** specified by your Internet service provider. For this example, select **IPoE** as the WAN encapsulation type.
  - Set the **IPv4/IPv6 Mode** to **IPv4 Only**.
- 3 Under **Routing Feature**, enable **NAT** and **Apply as Default Gateway**.
- 4 For the rest of the fields, use the default settings.
- 5 Click **Apply** to save your settings.

- Go to the **Network Setting > Broadband** screen to view the established Ethernet connection. The new connection is displayed on the **Broadband** screen.

#	Name	Type	Mode	Encapsulation	802.1p	802.1q	IGMP Proxy	NAT	Default Gateway	IPv6	MLD Proxy	Modify
1	My ETH Connecti	ETH	Routing	IPoE	N/A	N/A	N	Y	Y	N	N	

## Bridge Mode

- In this bridge mode example, configure the following information for the Ethernet WAN connection.

General	
Name	My ETH Connection
Type	Ethernet
Connection Mode	Bridge

- Enter the **General** settings provided by your Internet service provider.
  - Enter a **Name** to identify your WAN connection.
  - Set the **Type** to **Ethernet**.
  - Set your Ethernet connection **Mode** to **Bridge**.



- 3 For the rest of the fields, use the default settings.
- 4 Click **Apply** to save your settings.

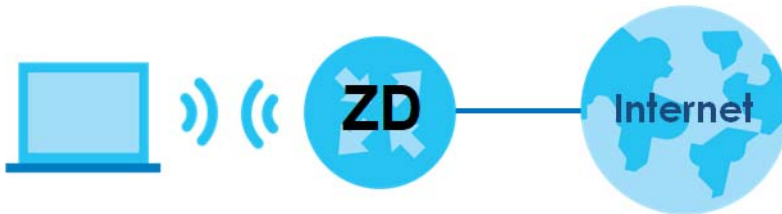
The screenshot shows the 'Edit WAN Interface' configuration page. It is divided into two main sections: 'General' and 'VLAN'. The 'General' section has a toggle switch that is turned on. Below it are three fields: 'Name' with the value 'My ETH Connection', 'Type' with a dropdown menu set to 'Ethernet', and 'Mode' with a dropdown menu set to 'Bridge'. The 'VLAN' section has a toggle switch that is turned off. Below it are two fields: '802.1p' with the value '0' and '802.1q' with the value '0' and a range '(0~4094)' to its right. At the bottom of the page, there are two buttons: 'Cancel' and 'Apply'. The 'Apply' button is circled in red.

## 5.3 WiFi Network Setup

For Zyxel Devices that support MPro Mesh, you can use the MPro Mesh app to configure your WiFi network. See [Section 6.1 on page 130](#) for setting up your WiFi network with the Zyxel MPro Mesh app.

In this example, you want to set up a WiFi network so that you can use your notebook to access the Internet. In this WiFi network, the Zyxel Device is an access point (AP), and the notebook is a WiFi client. The WiFi client can access the Internet through the AP.

**Figure 61** WiFi Network Setup



See the label on the Zyxel Device for the WiFi network settings and then connect manually to the Zyxel Device. Alternatively, you can connect to the Zyxel Device WiFi network using WPS. See [Section 5.3.2 on page 92](#).

### 5.3.1 Changing Security on a WiFi Network

This example changes the default security settings of a WiFi network to the following:

SSID	Example
Security Mode	WPA3-SAE/WPA2-PSK
Pre-Shared Key	DoNotStealMyWirelessNetwork
802.11 Mode	802.11b/g/n Mixed

- 1 Go to the **Network Setting > Wireless > General** screen. Select **More Secure** as the security level and **WPA3-SAE/WPA2-PSK** as the security mode. Configure the screen using the provided parameters. Click **Apply**.

A wireless network name (also known as SSID) and a security level are basic elements to start a wireless service. It is recommended to set a security level other than no security to protect your data from unauthorized access or damage via wireless network.

### Wireless

Wireless  Keep 2.4G and 5G wireless network name the same

### Wireless Network Setup

Band: 2.4GHz

Wireless:

Channel: Auto Current : 7 / 40 MHz

Bandwidth: 20MHz

Control Sideband: None

### Wireless Network Settings

Wireless Network Name: Example

Max Clients: 32

Hide SSID ⓘ

Multicast Forwarding

Max. Upstream Bandwidth:

Max. Downstream Bandwidth:

Note

(1) Max. Upstream Bandwidth: This field allows you to configure the maximum bandwidth of this SSID to WAN.  
 (2) Max. Downstream Bandwidth: This field allows you to configure the maximum bandwidth of WAN to this SSID.  
 (3) If Max. Upstream/Downstream Bandwidth is empty, the CPE sets the value automatically.  
 (4) Using Max. Upstream/Downstream Bandwidth will significantly decrease the wireless performance.

BSSID: 5C:E2:8C:8A:F0:FD

### Security Level

No Security More Secure (Recommended)

WPA3-SAE/WPA2-PSK

Generate password automatically

Enter 8-63 ASCII characters or 64 hexadecimal digits ("0-9", "A-F").

Password: DoNotStealMyWirelessNetwork ⓘ

AES

Timer: 3600 sec.

- 2 Go to the **Wireless > Others** screen. Set **802.11 Mode** to **802.11b/g/n Mixed**, and then click **Apply**.

**Wireless**

General | Guest/More AP | MAC Authentication | WPS | WMM | **Others** | Channel Status | MESH

The configurations below are the advanced wireless settings.

RTS/CTS Threshold	<input type="text" value="2347"/>	
Fragmentation Threshold	<input type="text" value="2346"/>	
Output Power	<input type="text" value="100%"/>	▼
Beacon Interval	<input type="text" value="100"/>	ms
DTIM Interval	<input type="text" value="1"/>	ms
802.11 Mode	<input type="text" value="802.11b/g/n Mixed"/>	▼
802.11 Protection	<input type="text" value="Auto"/>	▼
Preamble	<input type="text" value="Long"/>	
Protected Management Frames	<input type="text" value="Capable"/>	▼

You can now use the WPS feature to establish a WiFi connection between your notebook and the Zyxel Device (see [Section 5.3.2 on page 92](#)). Now use the new security settings to connect to the Internet through the Zyxel Device using WiFi.

## 5.3.2 Connecting to the Zyxel Device's WiFi Network Using WPS

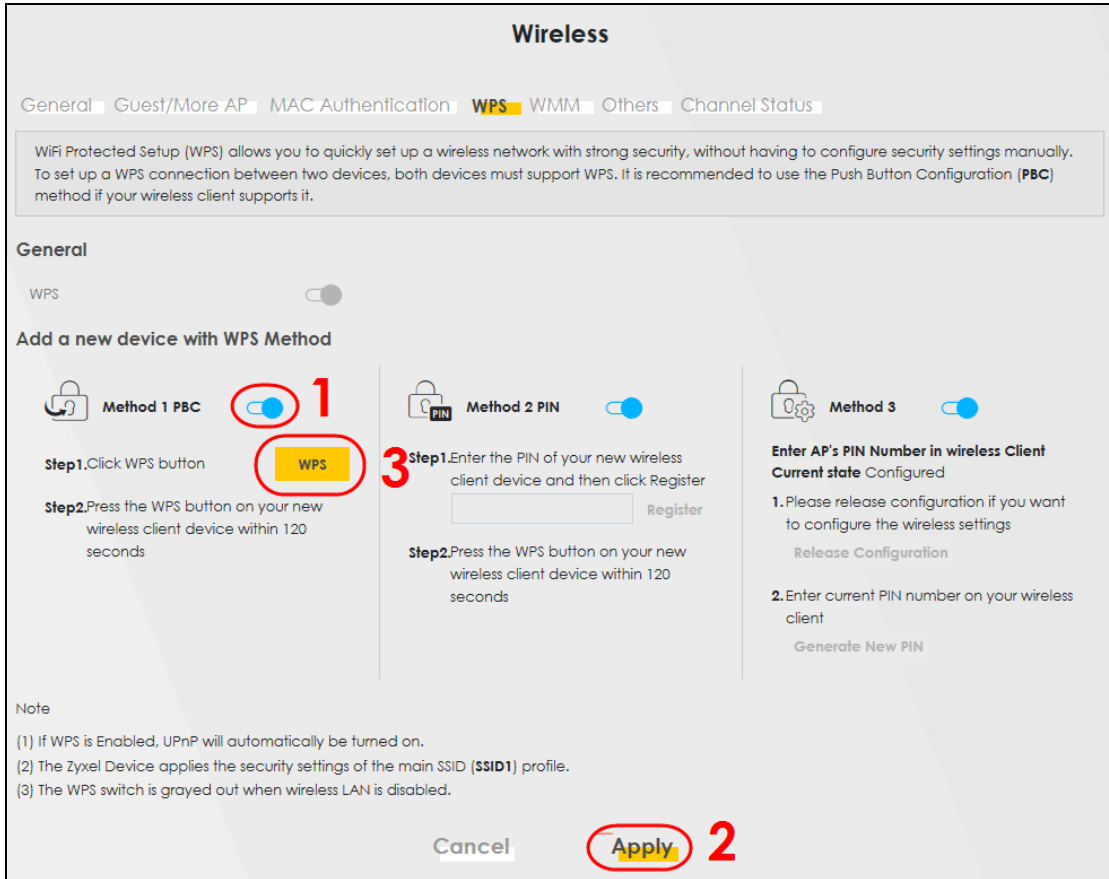
This section shows you how to connect a WiFi device to the Zyxel Device's WiFi network using WPS. WPS (Wi-Fi Protected Setup) is a security standard that allows devices to connect to a router securely without you having to enter a password. There are two methods:

- **Push Button Configuration (PBC)** – Connect to the WiFi network by pressing a button. This is the simplest method.
- **PIN Configuration** – Connect to the WiFi network by entering a PIN (Personal Identification Number) from a WiFi-enabled device in the Zyxel Device's Web Configurator. This is the more secure method, because one device can authenticate the other.

### 5.3.2.1 WPS Push Button Configuration (PBC)

This example shows how to connect to the Zyxel Device's WiFi network from a notebook computer running Windows 10.

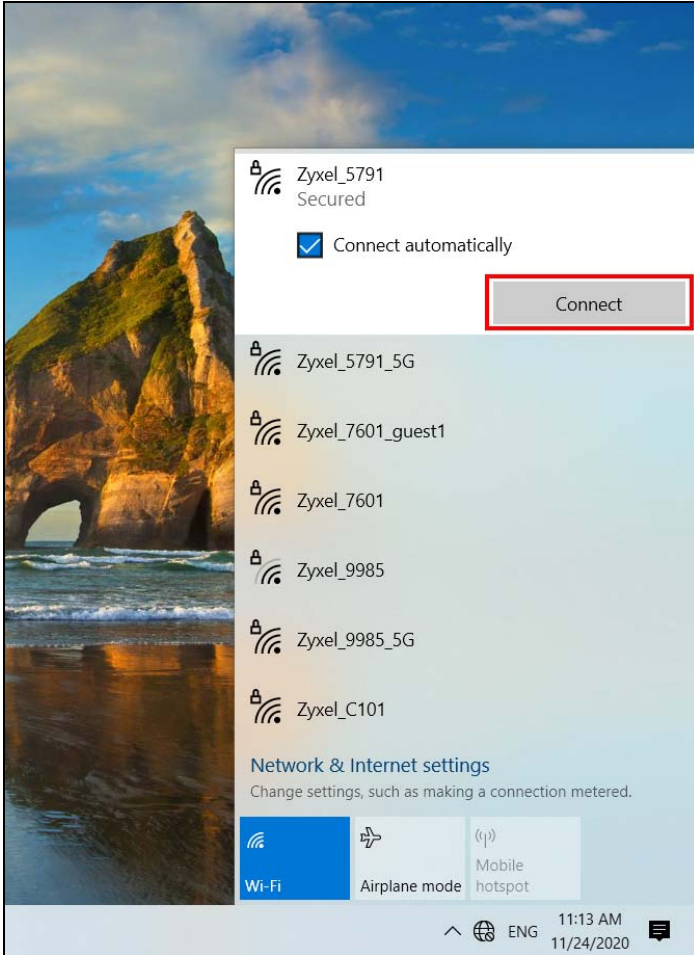
- 1 Make sure that your Zyxel Device is turned on, and your notebook is within range of the Zyxel Device's WiFi signal.
- 2 Push and hold the **WPS** button located on the Zyxel Device until the **WiFi** or **WPS** LED starts blinking slowly. Alternatively, log into the Zyxel Device's Web Configurator, and then go to the **Network Setting > Wireless > WPS** screen. Enable **WPS** and **Method 1 PBC**, click **Apply**, and then click the **WPS button**.



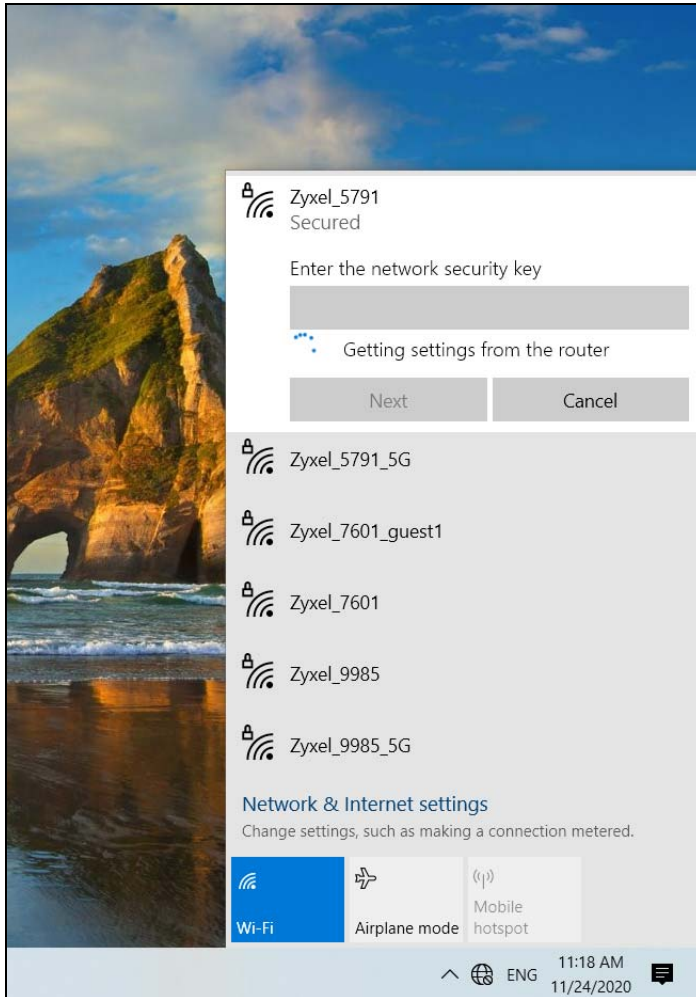
- 3 In Windows 10, click on the Network icon in the system tray to open the list of available WiFi networks.



- 4 Locate the WiFi network of the Zyxel Device. The default WiFi network name is "Zyxel\_XXXX" (2.4G) or "Zyxel\_XXXX\_5G" (5G). Then click **Connect**.



The Zyxel Device sends the WiFi network settings to Windows using WPS. Windows displays "Getting settings from the router".



The WiFi device is then able to connect to the WiFi network securely.

### 5.3.2.2 WPS PIN Configuration

The WPS PIN (Personal Identification Number) method is a more secure version of WPS, used by WiFi-enabled devices such as printers. To use this connection method, you need to log into the Zyxel Device's Web Configurator.

- 1 Enable WiFi on the device you want to connect to the WiFi network. Then, note down the WPS PIN in the device's WiFi settings.
- 2 Log into Zyxel Device's Web Configurator, and then go to the **Network Setting > Wireless > WPS** screen. Enable **WPS**, and then click **Apply**.
- 3 Enable **Method 2 PIN**, and then click **Apply**. Enter the PIN of the WiFi device, and then click **Register**.

WiFi Protected Setup (WPS) allows you to quickly set up a wireless network with strong security, without having to configure security settings manually. To set up a WPS connection between two devices, both devices must support WPS. It is recommended to use the Push Button Configuration (PBC) method if your wireless client supports it.

**General**

WPS

**Add a new device with WPS Method**

**Method 1 PBC**

**Step1.** Click WPS button

**Step2.** Press the WPS button on your new wireless client device within 120 seconds

**Method 2 PIN**  **1**

**Step1.** Enter the PIN of your new wireless client device and then click Register

**Step2.** Press the WPS button on your new wireless client device within 120 seconds

**Method 3**

**Enter AP's PIN Number in wireless Client**

**Current state** Configured

**3** Please release configuration if you want to configure the wireless settings

**2** Enter current PIN number on your wireless client

Note

- (1) If WPS is Enabled, UPnP will automatically be turned on.
- (2) The Zyxel Device applies the security settings of the **SSID1** profile. If you want to use the WPS feature, make sure you have set the security mode of **SSID1** to **WPA2-PSK** or **No Security**.
- (3) The WPS switch is grayed out when wireless LAN is disabled.

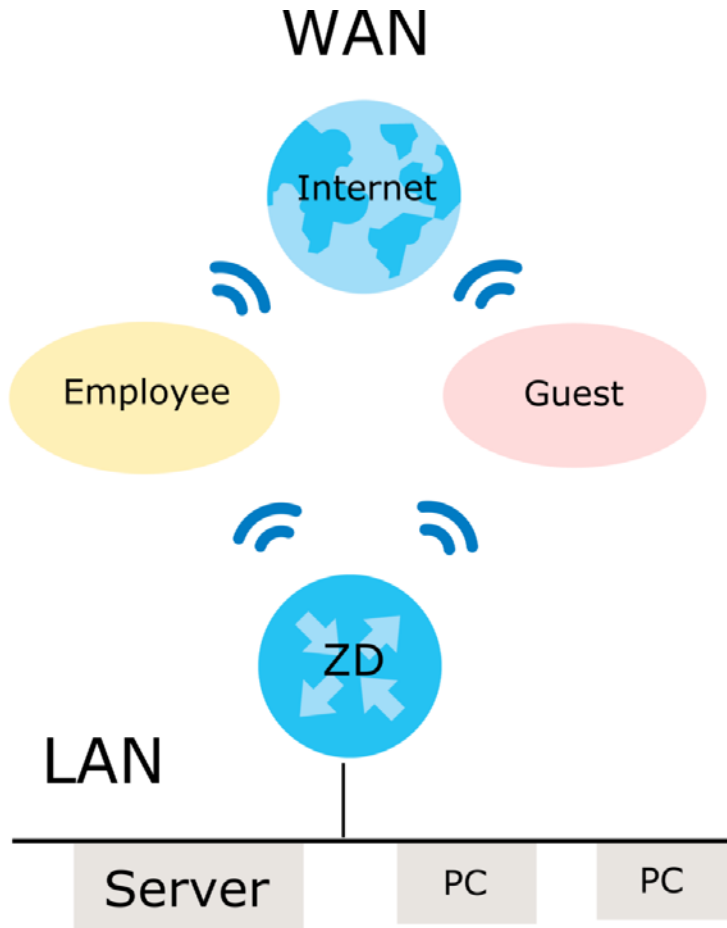
Cancel **Apply** **2**

- 4 Within 2 minutes, enable WPS on the WiFi device.

### 5.3.3 Setting Up a Guest Network

The Zyxel Device authenticates the WiFi device using the PIN, and then sends the WiFi network settings to the device using WPS. This process may take up to 2 minutes. The WiFi device is then able to connect to the WiFi network securely. A company wants to create two WiFi networks for different groups of users as shown in the following figure. Each WiFi network has its own SSID and security mode. Both networks are accessible on both 2.4G and 5G WiFi bands.



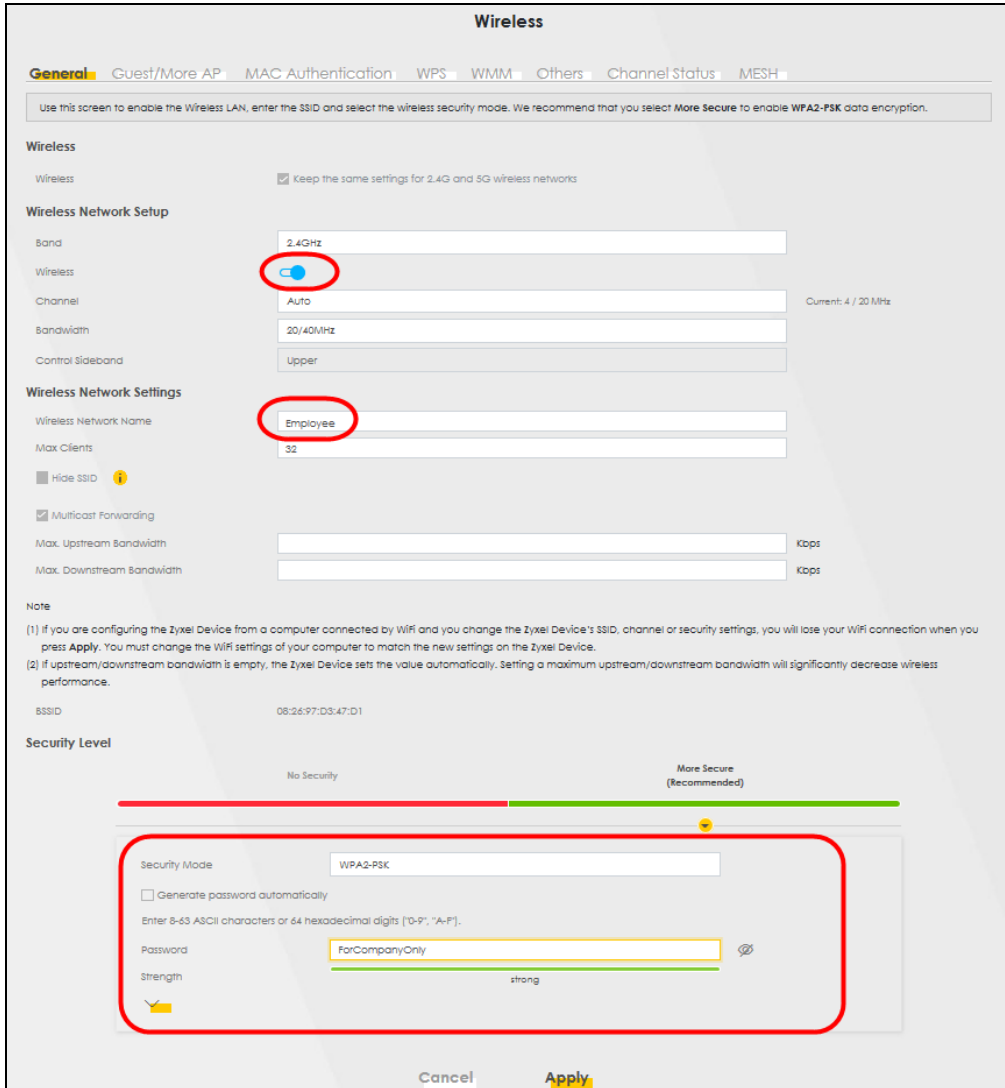


- Employees using the **General** WiFi network group will have access to the local network and the Internet.
- Visitors using the **Guest** WiFi network group with a different SSID and password will have access to the Internet only.

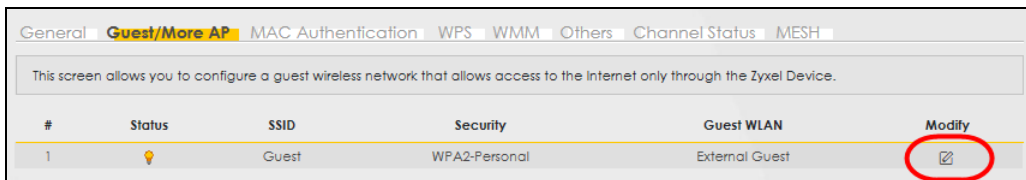
Use the following parameters to set up the WiFi network groups.

	GENERAL	GUEST
2.4/5G SSID	Employee	Guest
Security Level	More Secure	More Secure
Security Mode	WPA2-PSK	WPA2-PSK
Pre-Shared Key	ForCompanyOnly	guest123

Go to the **Network Setting > Wireless > General** screen. Use this screen to set up the company's general WiFi network group. Configure the screen using the provided parameters and click **Apply**. Note that if you have employees using 2.4G and 5G devices, enable **Keep the same settings for 2.4G and 5G wireless networks** to use the same SSID and password. Clear it if you want to configure different SSIDs and passwords for 2.4G and 5G bands.



- 5 Go to the **Network Setting > Wireless > Guest/More AP** screen. Click the **Modify** icon to configure the second WiFi network group.



- 6 On the **Guest/More AP** screen, click the **Modify** icon to configure the other Guest WiFi network group. Configure the screen using the provided parameters and click **OK**.

✕

### More AP Edit

Wireless security can protect the data from unauthorized access or damage via wireless network. You need a wireless network name (also known as SSID) and security mode to set up the wireless security.

**Wireless Network Setup**

Wireless

**Security Level**

Wireless Network Name:

Hide SSID

Guest WLAN

Access Scenario:

Max. Upstream Bandwidth:

Max. Downstream Bandwidth:

**Note**

(1) Max. Upstream Bandwidth: This field allows you to configure the maximum bandwidth of this SSID to WAN.

(2) Max. Downstream Bandwidth: This field allows you to configure the maximum bandwidth of WAN to this SSID.

(3) If Max. Upstream/Downstream Bandwidth is empty, the CPE sets the value automatically.

(4) Using Max. Upstream/Downstream Bandwidth will significantly decrease the wireless performance.

BSSID: 00:00:00:00:00:00

SSID Subnet:

**Security Level**

No Security
More Secure (Recommended)

Security Mode:

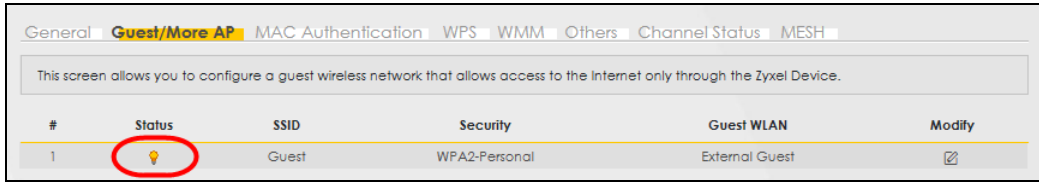
Generate password automatically

Enter 8-63 ASCII characters or 64 hexadecimal digits ("0-9", "A-F").

Password:  👁

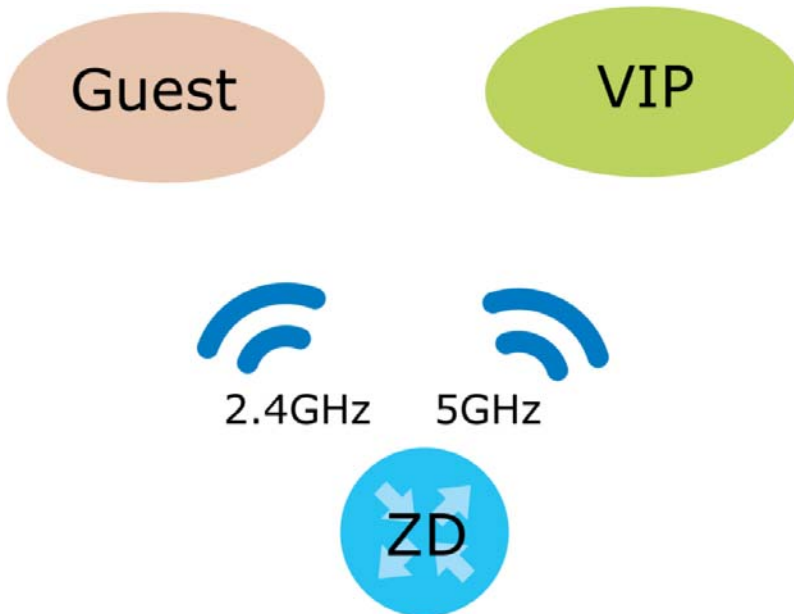
Cancel
OK

- 7 Check the status of **Guest** in the **Guest/More AP** screen. A yellow bulb under **Status** means the SSID is active and ready for WiFi access.



### 5.3.4 Setting Up Two Guest WiFi Networks on Different WiFi Bands

In this example, a company wants to create two Guest WiFi networks: one for the **Guest** group and the other for the **VIP** group as shown in the following figure. Each network will have its SSID and security mode to access the internet.



- The **Guest** group will use the 2.4G band.
- The **VIP** group will use the 5G band.

The Company will use the following parameters to set up the WiFi network groups.

Table 25 WiFi Settings Parameters Example

BAND	2.4G	5G
SSID	Guest	VIP
Security Mode	WPA3-SAE/WPA2-PSK	WPA3-SAE/WPA2-PSK
Pre-Shared Key	guest123	123456789

- 1 Go to the **Wireless > General** screen and set **Band** to **2.4GHz** to configure 2.4G Guest WiFi settings for **Guest**. Click **Apply**.

Note: You will not be able to configure the 2.4G and 5G Guest WiFi settings separately if **Keep the same settings for 2.4G and 5G wireless network** is enabled.

**Wireless**

**General** Guest/More AP MAC Authentication WPS WMM Others Channel Status

Use this screen to enable the Wireless LAN, enter the SSID and select the wireless security mode. We recommend that you select **More Secure** to enable **WPA2-PSK** data encryption.

**Wireless**

Keep the same settings for 2.4G and 5G wireless networks

**Wireless Network Setup**

Band

Wireless

Channel  Current: 3 / 20 MHz

Bandwidth

Control Sideband

**Wireless Network Settings**

Wireless Network Name

Max Clients

Hide SSID ⓘ

Multicast Forwarding

Max. Upstream Bandwidth  Kbps

Max. Downstream Bandwidth  Kbps

- 2 Go to the **Wireless > Guest/More AP** screen and click the **Modify** icon. The following screen appears. Configure the **Security Mode** and **Password** using the provided parameters and click **OK**.

**More AP Edit**

Use this screen to create Guest and additional wireless networks with different security settings.

**Wireless Network Setup**

Wireless

**Wireless Network Settings**

Wireless Network Name

Hide SSID

Guest WLAN

Access Scenario  d5

Max. Upstream Bandwidth  Kbps

Max. Downstream Bandwidth  Kbps

**Note**  
If upstream/downstream bandwidth is empty, the Zyxel Device sets the value automatically. Setting a maximum upstream/downstream bandwidth will significantly decrease wireless performance.

BSSID 0A:26:97:D3:47:D1

SSID Subnet

**Security Level**

No Security More Secure (Recommended)

---

Security Mode

Generate password automatically  
Enter 8-63 ASCII characters or 64 hexadecimal digits [0-9, "A-F"].

Password  @

Strength  medium

The 2.4 GHz **Guest** WiFi network is now configured.

**Wireless**

General **Guest/More AP** MAC Authentication WPS WMM Others Channel Status MESH

This screen allows you to configure a guest wireless network that allows access to the Internet only through the Zyxel Device.

#	Status	SSID	Security	Guest WLAN	Modify
1	<span style="color: orange;">⚠</span>	Guest	WPA2-Personal	External Guest	<input type="button" value="✎"/>

- Go to the **Wireless > General** screen and set **Band** to **5GHz** to configure the 5G Guest WiFi settings for **VIP**. Click **OK**.

## Wireless

**General**Guest/More APMAC AuthenticationWPSWMMOthersChannel Status

Use this screen to enable the Wireless LAN, enter the SSID and select the wireless security mode. We recommend that you select **More Secure** to enable **WPA2-PSK** data encryption.

**Wireless**

Keep the same settings for 2.4G and 5G wireless networks

**Wireless Network Setup**

Band

Wireless

Channel  Current: 60 / 160 MHz

Bandwidth

Control Sideband

**Wireless Network Settings**

Wireless Network Name

Max Clients

Hide SSID i

Multicast Forwarding

Max. Upstream Bandwidth  Kbps

Max. Downstream Bandwidth  Kbps

- 4 Go to the **Wireless > Guest/More AP** screen and click the **Modify** icon. The following screen appears. Configure the **Security Mode** and **Password** using the provided parameters and click **OK**.

**More AP Edit**

Use this screen to create Guest and additional wireless networks with different security settings.

**Wireless Network Setup**

Wireless

**Wireless Network Settings**

Wireless Network Name

Hide SSID

Guest WLAN

Access Scenario

Max. Upstream Bandwidth  Kbps

Max. Downstream Bandwidth  Kbps

**Note**  
If upstream/downstream bandwidth is empty, the Zyxel Device sets the value automatically. Setting a maximum upstream/downstream bandwidth will significantly decrease wireless performance.

BSSID

SSID Subnet

**Security Level**

No Security More Secure (Recommended)

Security Mode

Generate password automatically  
Enter 8-63 ASCII characters or 64 hexadecimal digits ["0-9", "A-F"].

Password

Strength

The 5G **VIP** WiFi network is now configured.

**Wireless**

General **Guest/More AP** MAC Authentication WPS WMM Others Channel Status MESH

This screen allows you to configure a guest wireless network that allows access to the Internet only through the Zyxel Device.

#	Status	SSID	Security	Guest WLAN	Modify
1	🔦	VIP	WPA2-Personal	External Guest	✎



## 5.4 USB Applications

This section shows you how to set up a cellular backup network, access shared folders and play files through Window Media using a USB device.

### 5.4.1 File Sharing

This section shows you how to create a shared folder on your Zyxel Device through a USB device and allow others to access the shared folder with File Sharing services.

#### 5.4.1.1 Setting up File Sharing on Your Zyxel Device

- 1 Before enabling file sharing in the Zyxel Device, please set up your shared folders beforehand in your USB device.
- 2 Connect your USB device to the USB port of the Zyxel Device.
- 3 Go to the **Network Setting > USB Service > File Sharing** screen. Enable **File Sharing Services** and click **Apply** to activate the file sharing function. The Zyxel Device automatically adds your USB device to the **Information** table.

**USB Service**

**FileSharing** MediaServer

The device can share Files from your USB flash drive or disk when you attach it to the USB port. You may Start from decliding which folders in the USB disks to share and which users can access the shared folders.

**Information**

Volume	Capacity	Used Space
usb1_sda1	0 MB	0 MB

**Server Configuration**

File Sharing Services

**Share Directory List** + Add New Share

Active	Status	Share Name	Share Path	Share Description	Modify
--------	--------	------------	------------	-------------------	--------

**Account Management** + Add New User

Status	User Name
	admin

Cancel **Apply**

- 4 Click **Add New Share** to add a new share.

### USB Service

**FileSharing** MediaServer

The device can share Files from your USB flash drive or disk when you attach it to the USB port. You may Start from deciding which folders in the USB disks to share and which users can access the shared folders.

**Information**

Volume	Capacity	Used Space
usb1_sda1	0 MB	0 MB

**Server Configuration**

File Sharing Services

**Share Directory List** + Add New Share

Active	Status	Share Name	Share Path	Share Description	Modify

**Account Management** + Add New User

Status	User Name
	admin

Cancel Apply

- 5 The **Add New Share** screen appears.
- Select your USB device from the **Volume** drop-down list box.
  - Enter a **Description** name for the added share to identify the device.
  - Click **Browse** and the **Browse Directory** screen appears.

### Add New Share

Volume: usb1\_sda1

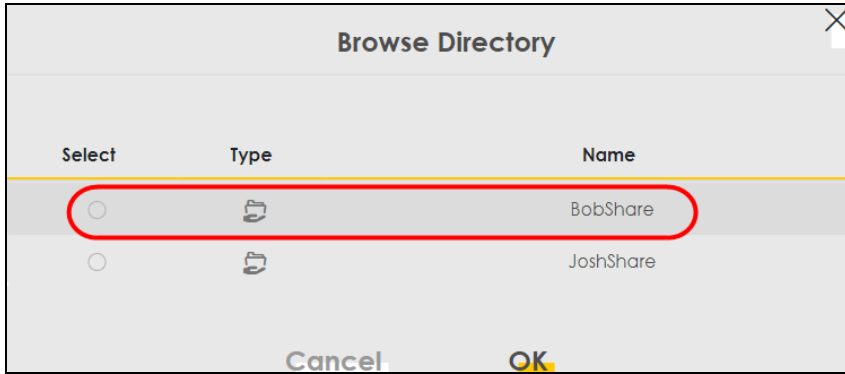
Share Path: BobShare Browse

Description: Bob

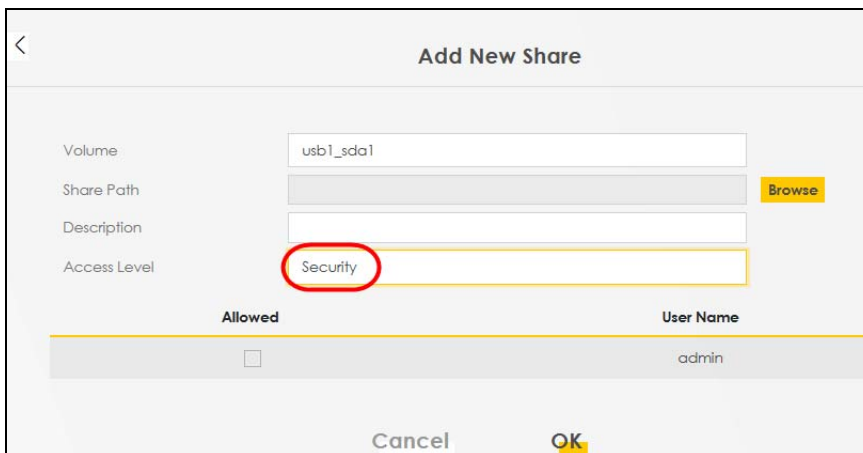
Access Level: Public

Cancel OK

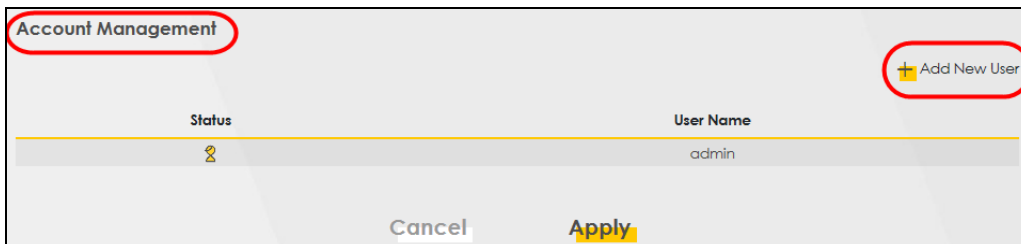
- On the **Browse Directory** screen, select the folder that you want to add as a share. In this example, select **BobShare** and then click **OK**.



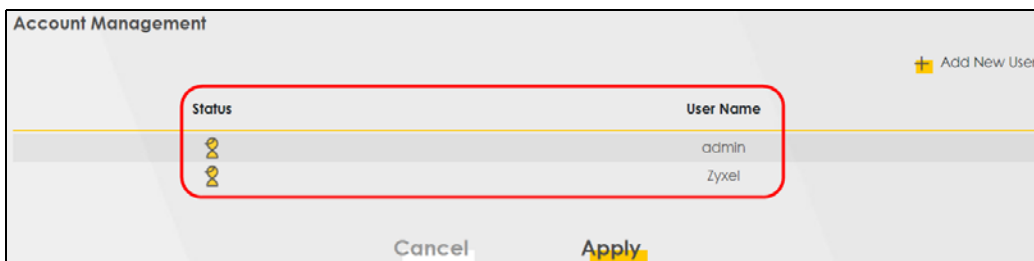
- In **Access Level**, select **Public** to let the share to be accessed by all users connected to the Zyxel Device. Otherwise, select **Security** to let the share to be accessed by specific users to access only. Click **OK** to save the settings.



- 6 To set **Access level** to **Security**, you need to create one or more users accounts. Under **Account Management**, click **Add New User** to open the **User Account** screen.



- 7 After you create a new user account, the screen looks like the following.



- 8 File sharing is now configured. You can see the USB storage device listed in the table below.

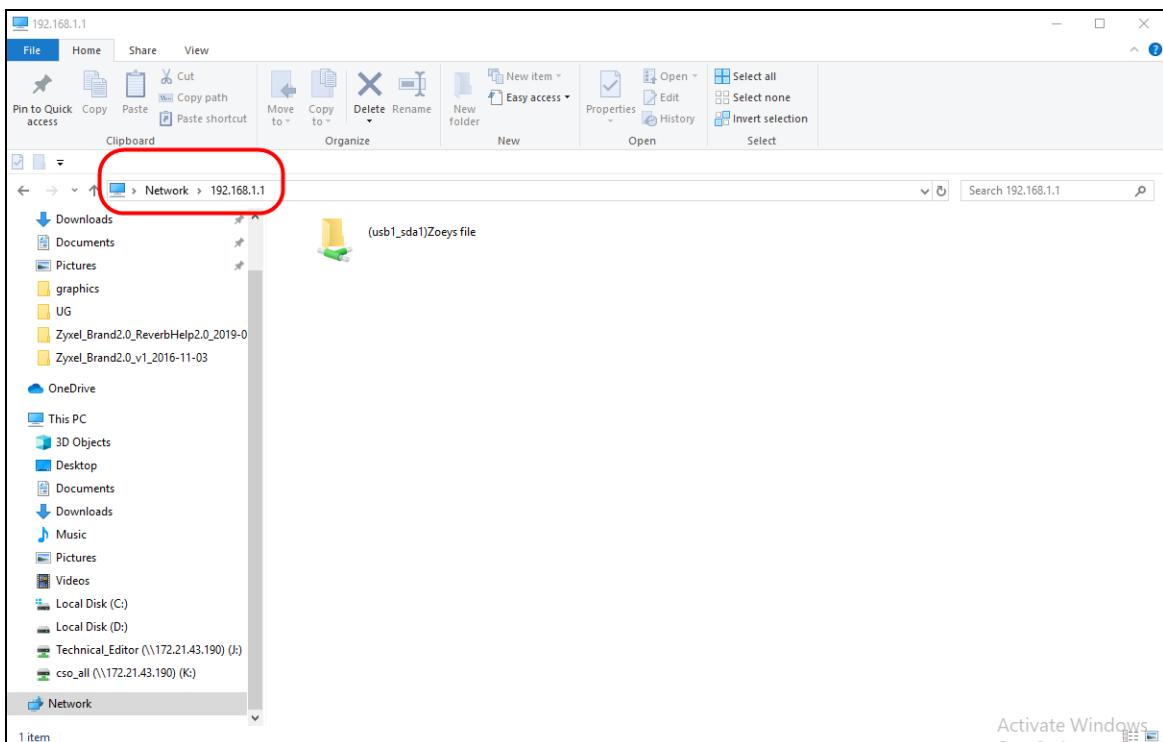
Share Directory List						
Active	Status	Share Name	Share Path	Share Description	Modify	
<input checked="" type="checkbox"/>		BobShare	/mnt/usb1_sda1/BobShare	Bob		
<input checked="" type="checkbox"/>		JoshShare	/mnt/usb1_sda1/JoshShare	Josh		

### 5.4.1.2 Accessing Your Shared Files From a Computer

You can use Windows Explorer to access the USB storage devices connected to the Zyxel Device.

Note: This example shows you how to use Microsoft Windows 10 to browse shared files in a share called (usb1\_sda)Zoey's file. Refer to your operating system's documentation for how to browse your file structure.

- 1 Open Windows Explorer.
- 2 In the Windows Explorer's address bar, enter a double backslash "\\\" followed by the IP address of the Zyxel Device (the default IP address of the Zyxel Device is 192.168.1.1)



- 3 Double-click on **(usb1\_sda)Zoey's file**, and then enter the share's username and password if prompted.
- 4 After you access **(usb1\_sda)Zoey's file** through your Zyxel Device, you do not have to log in again unless you restart your computer.

### 5.4.2 Media Server

Use the media server feature to play files on a computer or on your television.

This section shows you how the media server feature works using the following:

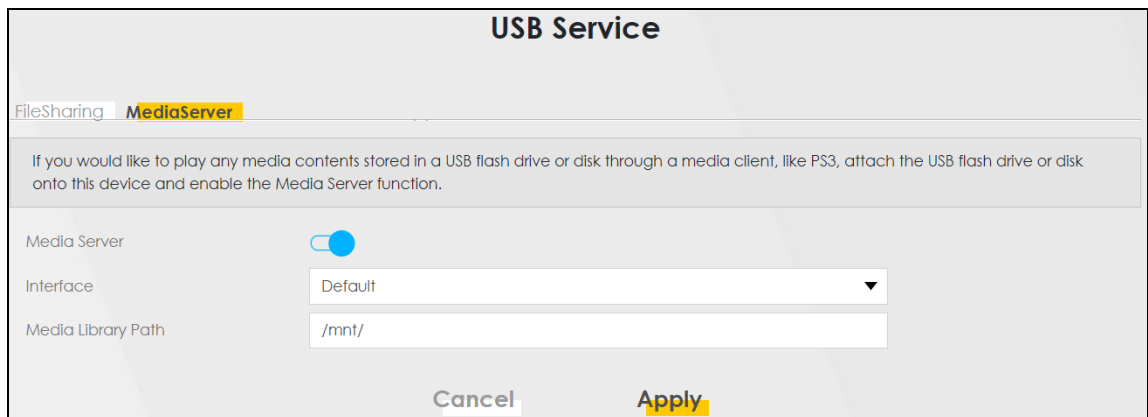
- Microsoft (MS) Windows Media Player  
Media Server works with Windows 10. Make sure your computer is able to play media files (music, videos and pictures).
- A digital media adapter  
You need to set up the media adapter to work with your television (TV).

Before you begin, connect the USB storage device containing the media files you want to play to the USB port of your Zyxel Device.

### 5.4.2.1 Configuring the Zyxel Device

To use your Zyxel Device as a media server, follow the steps below.

- 1 Go to the **Network Setting > USB Service > Media Server** screen.



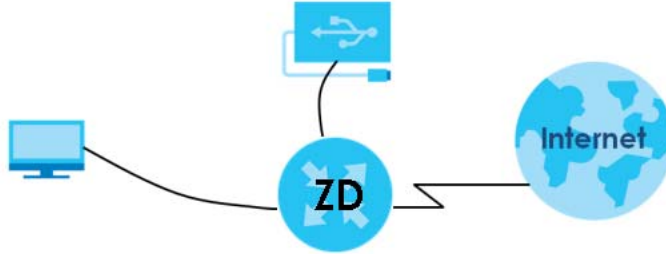
The screenshot shows the 'USB Service' configuration page. At the top, there are two tabs: 'FileSharing' and 'MediaServer', with 'MediaServer' selected. Below the tabs is a grey box containing the text: 'If you would like to play any media contents stored in a USB flash drive or disk through a media client, like PS3, attach the USB flash drive or disk onto this device and enable the Media Server function.' Underneath this box, there are three settings: 'Media Server' with a blue toggle switch turned on; 'Interface' with a dropdown menu showing 'Default'; and 'Media Library Path' with a text input field containing '/mnt/'. At the bottom of the page, there are two buttons: 'Cancel' and 'Apply', with 'Apply' highlighted in yellow.

- 2 Enable **Media Server**, and then select an interface on which you want to enable the media server function.
- 3 Enter the path clients use to access the media files on a USB storage device connected to the Zyxel Device, and click **Apply**.

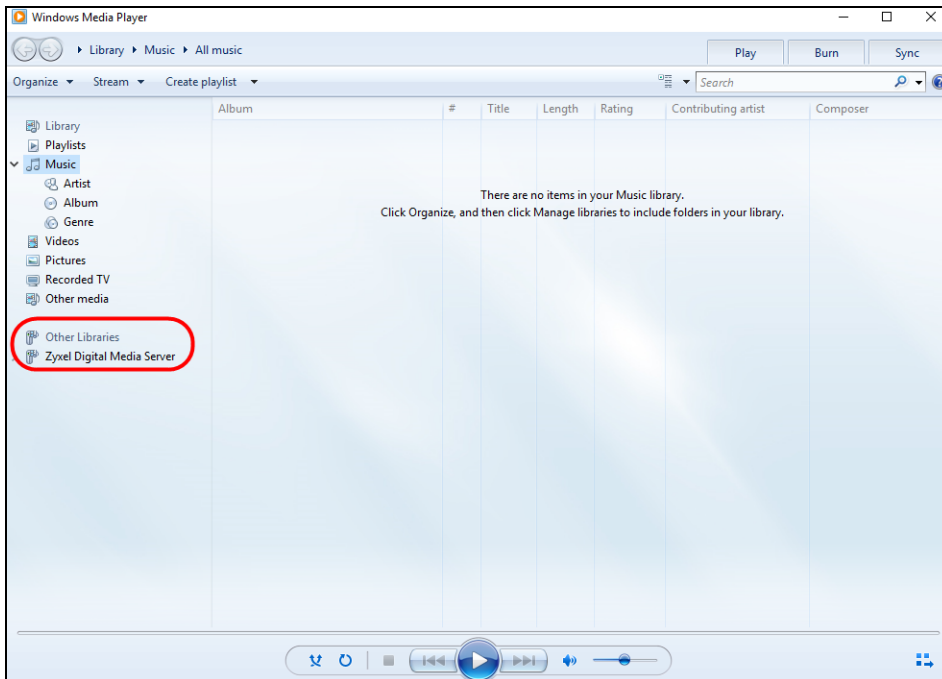
This enables DLNA-compliant media clients to play the video, music and image files in your USB storage device.

### 5.4.2.2 Playing Media Using Windows Media Player on Windows 10

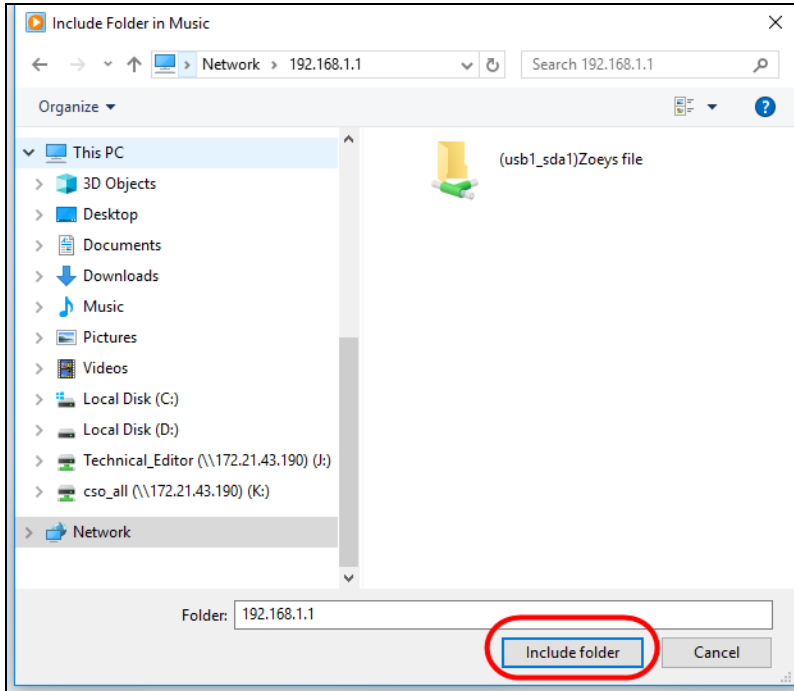
This section shows you how to play the media files on the USB storage device connected to your Zyxel Device using Windows Media Player.



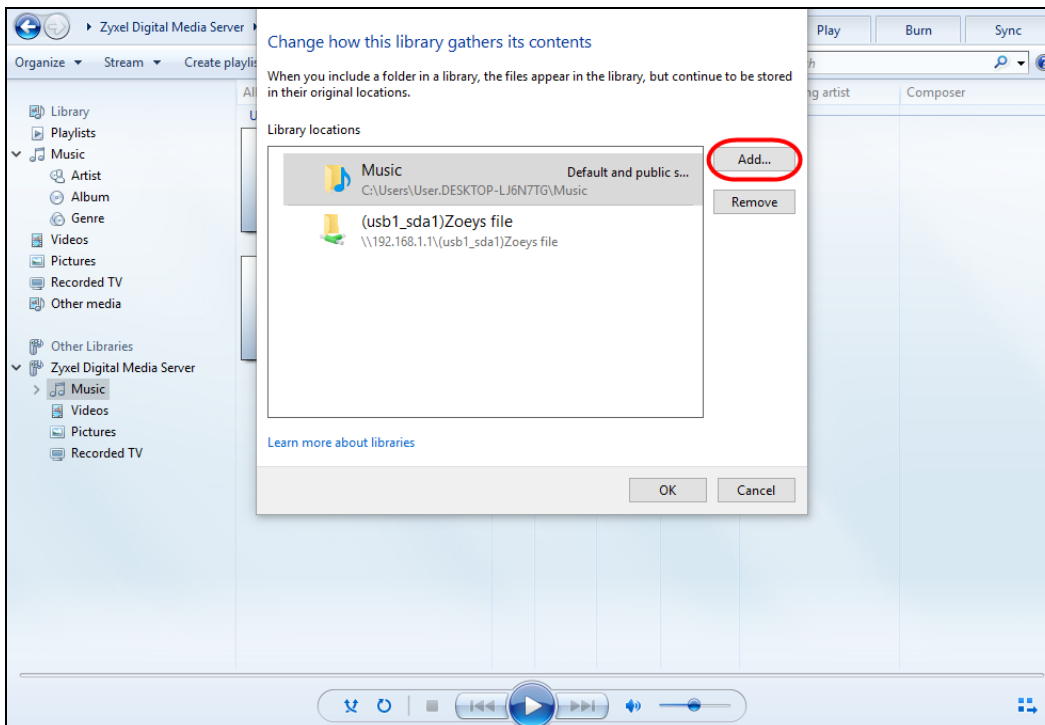
- 1 Open Windows Media Player. It automatically detects the Zyxel Device.



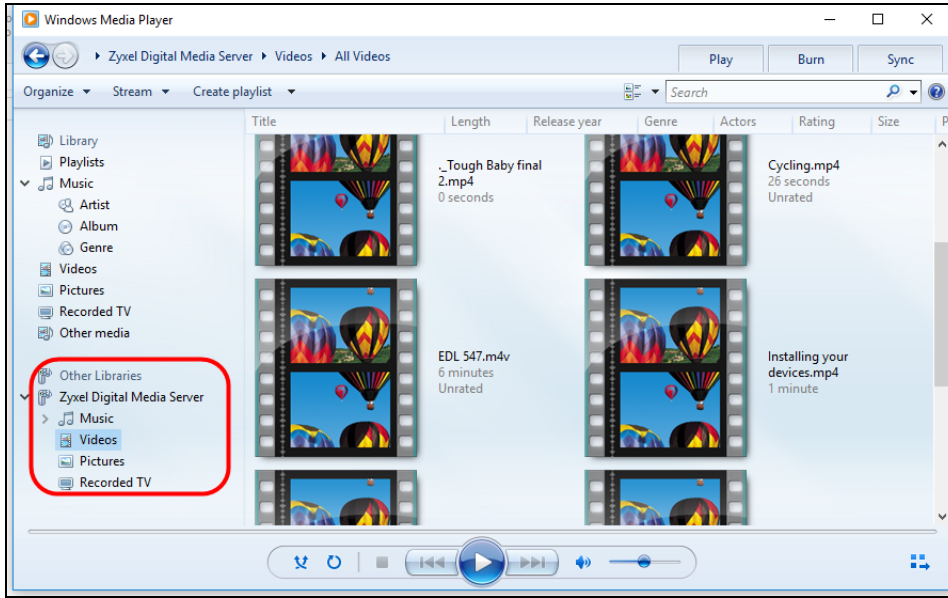
- 2 If you cannot see the Zyxel Device in the left panel as shown above, go to **Organize > Manage Libraries > Music > Add** on the Windows Media Player Home screen. In the Windows Explorer's address bar, enter `\\192.168.1.1`. The following screen appears. Select the folder containing the media you wish to upload to Windows Media Player, and then click **Include Folder**.



- 3 Select the shared folder, and then click **Add** to add it to your Media Library. Click **OK** to save the settings.



- 4 In the right panel, you can browse and play the files available in the USB storage device based on the category (**Music**, **Video**, **Pictures**, **Recorded TV**) you selected.

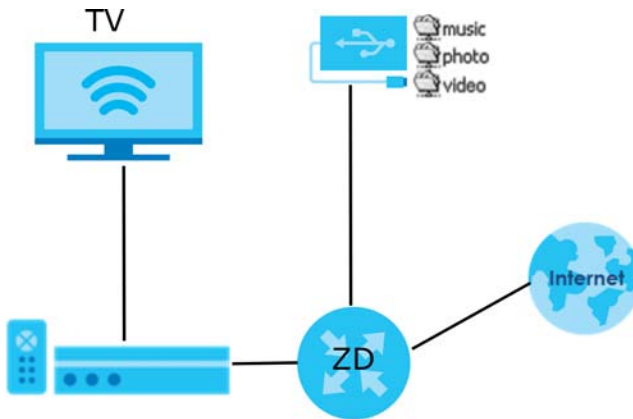


### 5.4.2.3 Using a Digital Media Player

This section shows you how you can use the Zyxel Device with a hardware digital media player to play media files stored in the USB storage device on your TV screen.

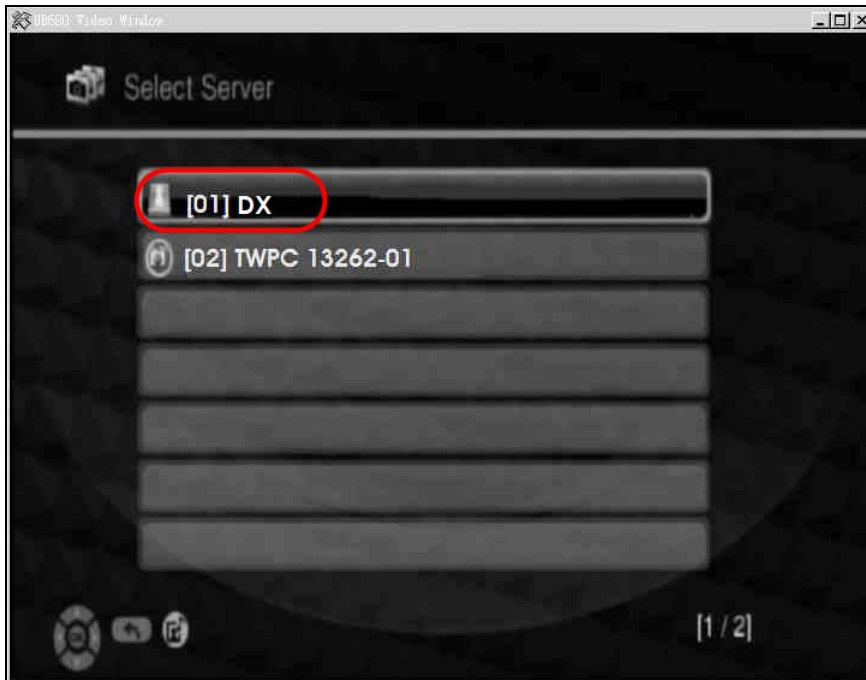
Note: For this tutorial, your digital media player is already connected to the TV.

- 1 Connect the digital media player to an available LAN port on your Zyxel Device.



- 2 Turn on the TV and wait for the digital media player **Home** screen to appear. Select the Zyxel Device as your media server.





- 3 The screen shows you the list of available media files in the USB storage device. Select the file you want to open and push the **Play** button on the remote control.

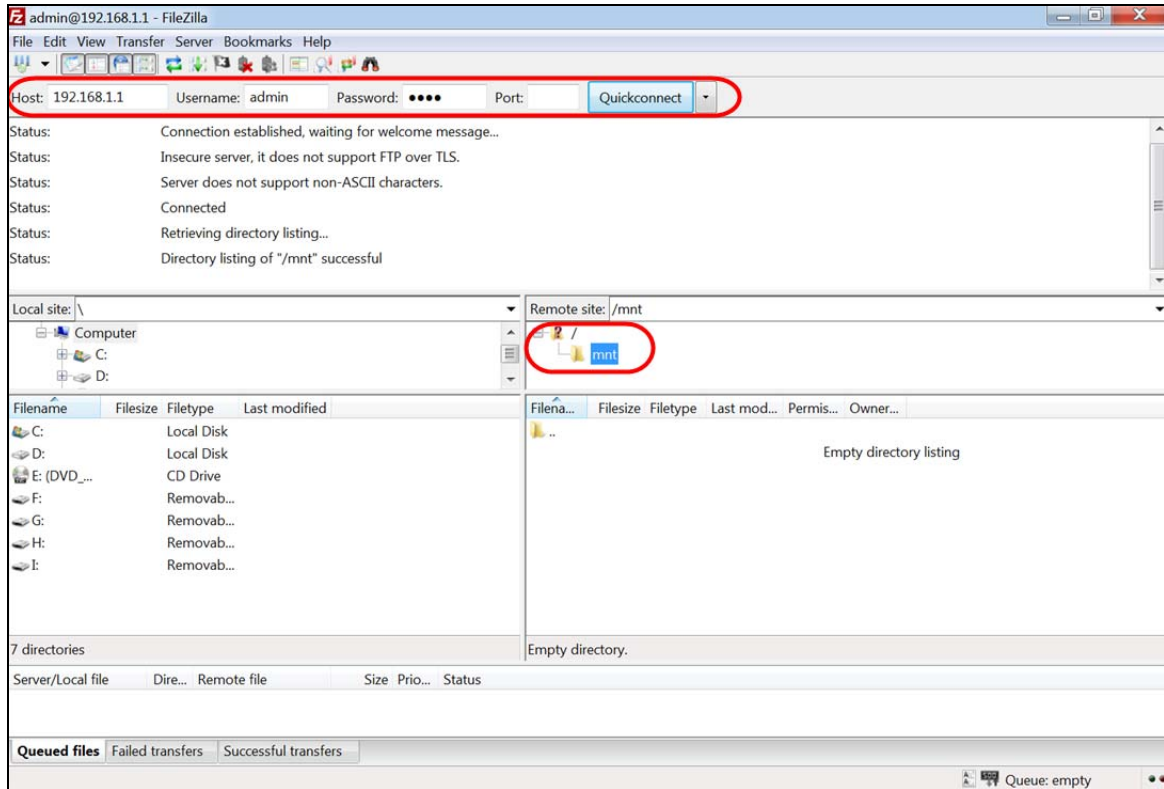


### 5.4.3 Using FTP

This section shows how to use an FTP program to access files on an USB storage device connected to the Zyxel Device.

Note: This example uses the FileZilla FTP program to browse your shared files.

- 1 In FileZilla, enter the IP address of the Zyxel Device (The default IP is **192.168.1.1**), your account's **Username**, **Password** and **Port** number, and then click **Quickconnect**. A screen asking for password authentication appears.



- 2 After you log in, the **mnt** folder is displayed as shown.

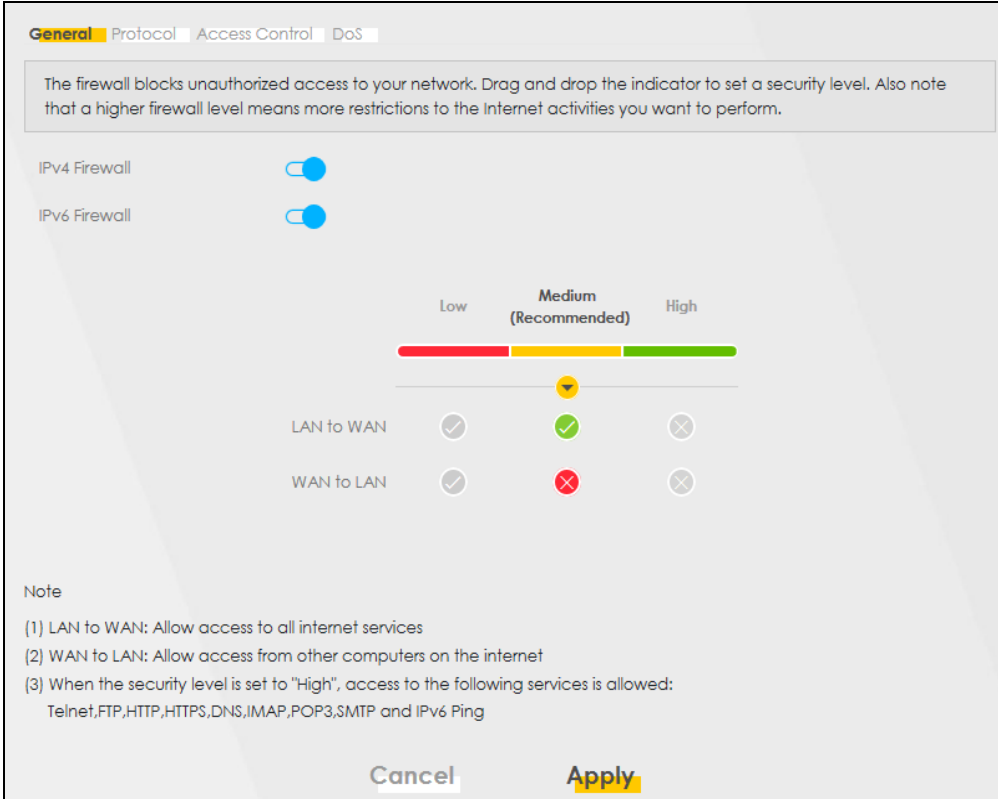
## 5.5 Network Security

This section shows you how to configure a Firewall rule, Parental Control rule, and MAC Filter rule.

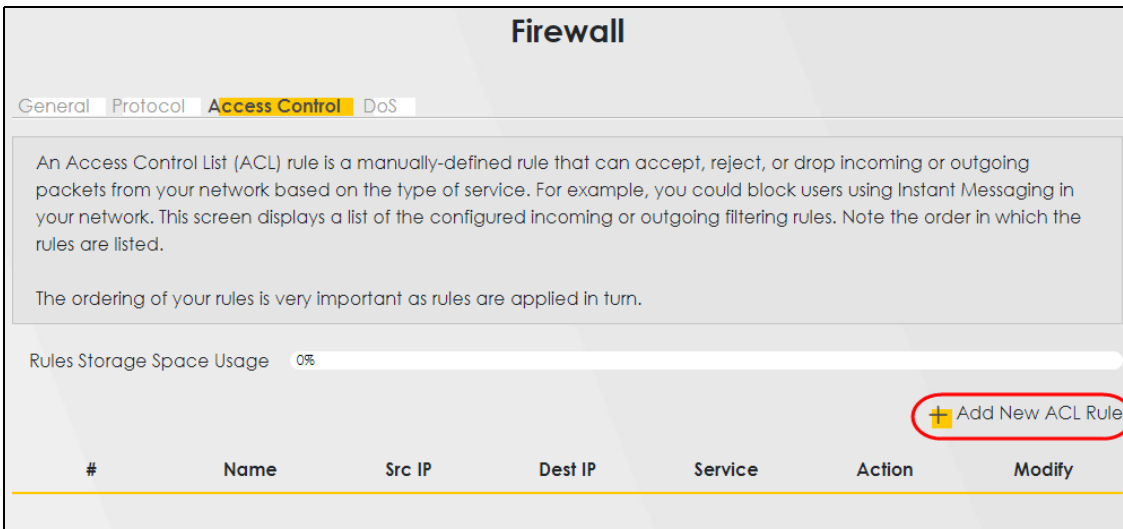
### 5.5.1 Configuring a Firewall Rule

You can enable the firewall to protect your LAN computers from malicious attacks from the Internet.

- 1 Go to the **Security > Firewall > General** screen.
- 2 Select **IPv4 Firewall/IPv6 Firewall** to enable the firewall, and then click **Apply**.



- 3 Open the **Access Control** screen, click **Add New ACL Rule** to create a rule.



- 4 Use the following fields to configure and apply a new ACL (Access Control List) rule.

- **Filter Name:** Enter a name to identify the firewall rule.
- **Source IP Address:** Enter the IP address of the computer that initializes traffic for the application or service.
- **Destination IP Address:** Enter the IP address of the computer to which traffic for the application or service is entering.
- **Protocol:** Select the protocol (**ALL**, **TCP/UDP**, **TCP**, **UDP**, **ICMP** or **ICMPv6**) used to transport the packets.
- **Policy:** Select whether to (**ACCEPT**, **DROP**, or **REJECT**) the packets.
- **Direction:** Select the direction (**WAN to LAN**, **LAN to WAN**, **WAN to ROUTER**, or **LAN to ROUTER**) of the traffic to which this rule applies.

- 5 Select **Enable Rate Limit** to activate the rules you created. Click **OK**.

## 5.5.2 Parental Control

This section shows you how to configure rules for accessing the Internet using parental control.

Note: The style and features of your parental control vary depending on the Zyxel Device you are using.

### 5.5.2.1 Configuring Parental Control Schedule and Filter

Parental Control Profile (**PCP**) allows you to set up a rule for:

- Internet usage scheduling.

- Websites and URL keyword blocking.

Use this feature to:

- Limit the days and times a user can access the Internet.
- Limit the websites a user can access on the Internet.

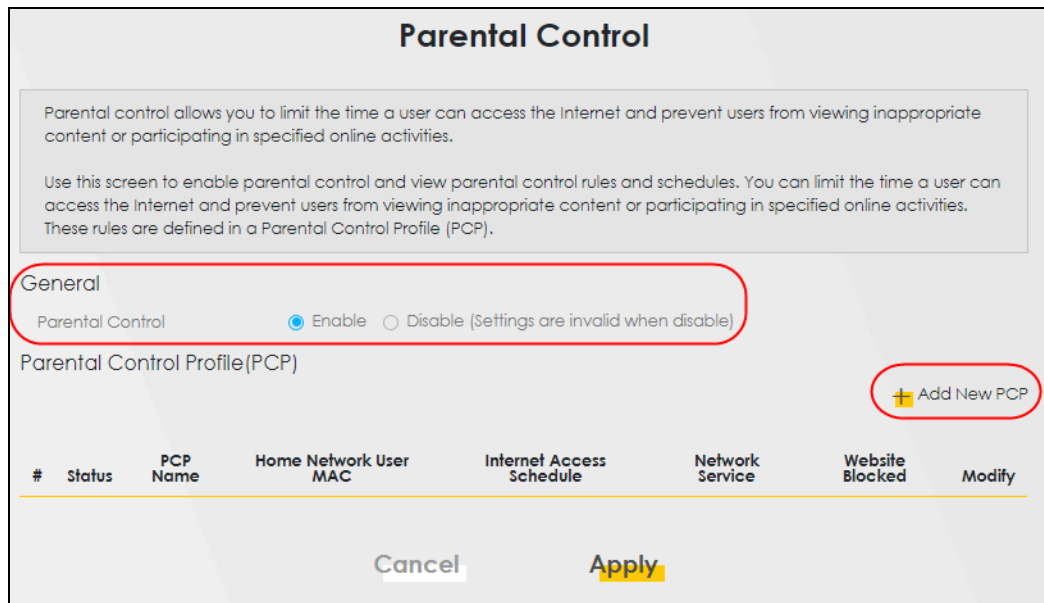
This example shows you how to block a user from accessing the Internet during time for studying. It also shows you how to stop a user from accessing specific websites.

Use the parameters below to configure a schedule rule and a URL keyword blocking rule.

PROFILE NAME	INTERNET ACCESS SCHEDULE	NETWORK SERVICE	SITE/URL KEYWORD
Study	<b>Day:</b> Monday to Friday  <b>Time:</b> 8:00 to 11:00 13:00 to 17:00	<b>Network Service Setting:</b> Block  <b>Service Name:</b> HTTP  <b>Protocol:</b> TCP  <b>Port:</b> 80	<b>Block or Allow the Web Site:</b> Block the web URLs  <b>Website:</b> gambling

## Parental Control Screen

Open the **Parental Control** screen. Select **Enable** under **General** to enable parental control. Then click **Add New PCP** to add a rule.



## Add New PCP Screen

### 1 Go to Parental Control > Add New PCP. Under General:

- Select **Enable** to enable the rule you are configuring.
- Enter the **Parental Control Profile Name** given in the above parameter.
- Select an user this rule applies to in **Home Network User**, then click **Add**. You will see the MAC address of the user you just select in **Rule List**.

General

Active  Enable  Disable (Settings are invalid when disable)

Parental Control Profile Name

Home Network User

---

Rule List

User MAC Address	Delete
DC-4A-3E-40-EC-67	<input type="button" value="Delete"/>

### 2 Under Internet Access Schedule:

- Click **Add New Time** to add a second schedule.
- Use the parameter given above to configure the time settings of your schedule.

Internet Access Schedule

Day  Mon  Tue  Wed  Thu  Fri  Sat  Sun

Time (Start-End)

08:00 11:00

13:00 17:00

### 3 Under Network Service:

- In **Network Service Setting**, select **Block**.
- Click **Add New Service**, then use the parameter given above to configure settings for the Internet service you are blocking.

Network Service

Network Service Setting: Block Selected Service(s)

+ Add New Service

#	Service Name	Protocol:Port	Modify
1	http	TCP:80	[Edit] [Delete]

**4** Under **Site / URL Keyword**:

- Select **Block the web URLs** in **Block or Allow the Web Site**.
- Click **Add**, then use the parameter given above to configure settings for the URL keyword you are blocking.
- Select **Redirect blocked site to Zyxel Family Safety page** to redirect the web browser to the Zyxel Family Safety page if he or she tries to access a website with the blocked URL keyword.

Site/URL Keyword

Block or Allow the Web Site: Block the web URLs

+ Add

#	Website	Modify
1	gambling	[Edit] [Delete]

Redirect blocked site to Zyxel Family Safety page ! Zyxel Family Safety page will replace any sites from the above list in the browser.

- 5** Click **OK** to save your settings.

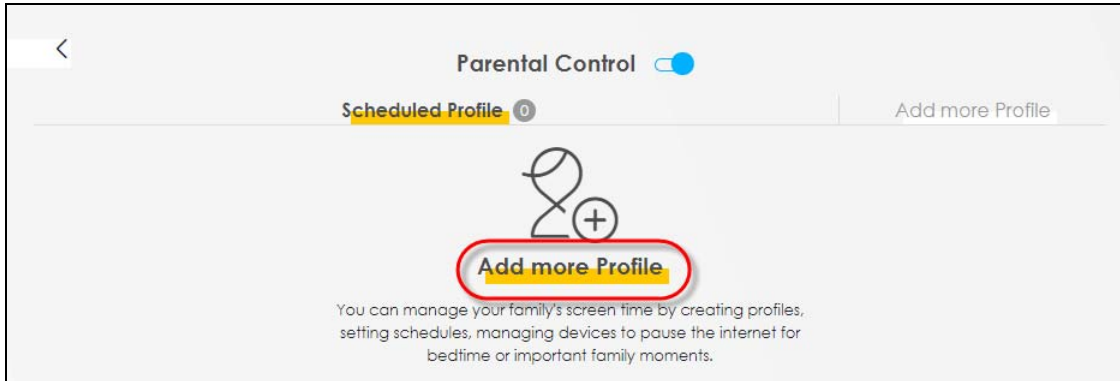
### 5.5.2.2 Configuring a Parental Control Schedule

Parental Control Profile allows you to set up a schedule rule for Internet usage. Use this feature to limit the days and times a user can access the Internet.

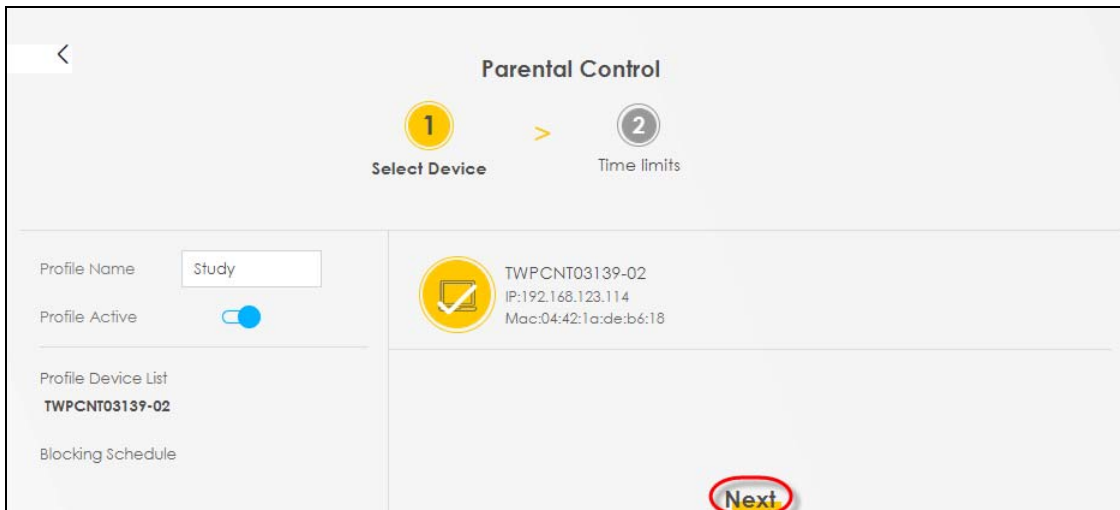
This example shows you how to block an user from accessing the Internet during time for studying. Use the parameter below to configure a schedule rule.

PROFILE NAME	START BLOCKING	END BLOCKING	REPEAT ON
Study	8:00 am	11:00 am	from Monday to Friday
	1:00 pm	5:00 pm	from Monday to Friday

- 1** Click **Add more Profile** to open the **Parental Control** screen.



- 2 Use this screen to add a Parental Control rule.
  - Enter the **Profile Name** given in the above parameter.
  - Click on the switch to enable **Profile Active**.
  - Select a device, and then click **Next** to proceed.



- 3 Use this screen to edit the Parental Control schedule.
  - Click **Add New Schedule** to add a second schedule.
  - Use the parameter given above to configure the time settings of your schedules.
  - Click **Save** to save the settings.

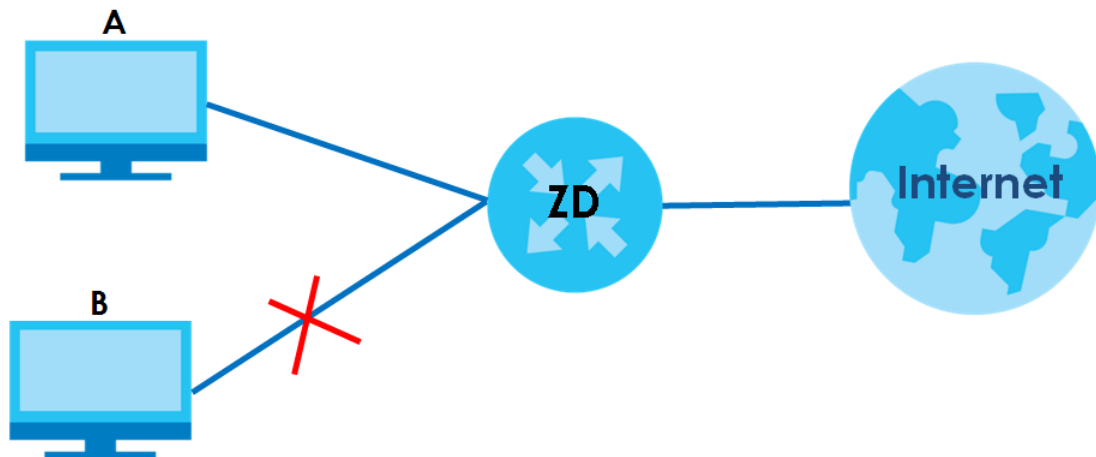


### 5.5.3 Configuring a MAC Address Filter for Wired LAN Connections

You can use a MAC address filter to exclusively allow or permanently block someone from the wired LAN network.

This example shows that computer B is not allowed access to the wired LAN network.

**Figure 62** Configure a MAC Address Filter Example



- 1 Go to the **Security > MAC Filter > MAC Filter** screen. Under **MAC Address Filter**, select **Enable**.

### MAC Filter

You can configure the Zyxel Device to permit access to clients based on their MAC addresses in the **MAC Filter** screen. This applies to wired and wireless connections. Every Ethernet device has a unique MAC (Media Access Control) address. The MAC address is assigned at the factory and consists of six pairs of hexadecimal characters, for example, 00:A0:C5:00:00:02. You need to know the MAC addresses of the LAN client to configure this screen.

MAC Address Filter  Enable  Disable (Settings are invalid when disable)

MAC Restrict Mode  Allow  Deny

[+ Add New Rule](#)

Set	Active	Host Name	MAC Address	Delete

Note  
Enable **MAC Address Filter** and add the host name and MAC address of a LAN client to the table if you wish to allow or deny them access to your network.

[Cancel](#) [Apply](#)

- 2 Click **Add New Rule** to add a new entry. Select **Active**, and then enter the **Host Name** and **MAC Address** of computer B. Click **Apply**.

MAC Address Filter  Enable  Disable (Settings are invalid when disable)

MAC Restrict Mode  Allow  Deny

[+ Add New Rule](#)

Set	Active	Host Name	MAC Address	Delete
1	<input checked="" type="checkbox"/>	B	00 - 24 - 21 - AB - 1F - 00	

[Cancel](#) [Apply](#)

## 5.6 Internet Calls

This section shows you how to make Internet calls.

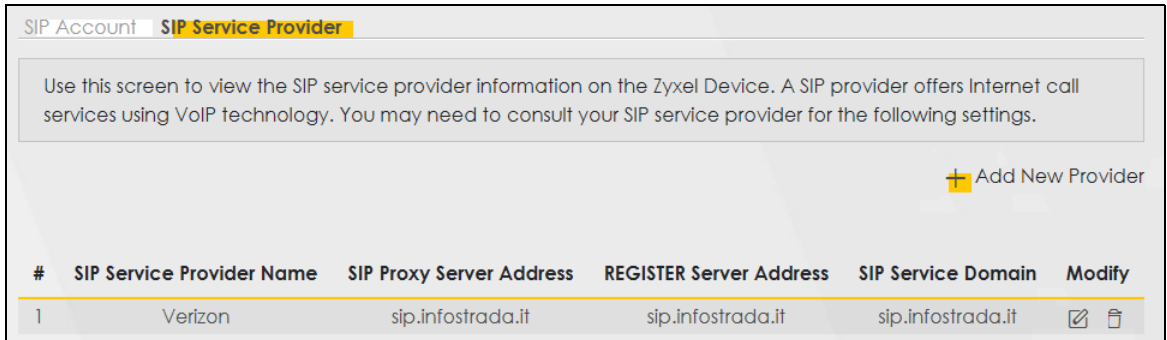
### 5.6.1 Configuring VoIP

To make voice calls over the Internet, you must set up a Session Initiation Protocol (SIP) provider and SIP account on the Zyxel Device. You should have an account with a SIP service provider already set up.

## 5.6.2 Adding a SIP Service Provider

Follow the steps below to add a SIP service provider.

- 1 Make sure your Zyxel Device is connected to the Internet.
- 2 Open the Web Configurator.
- 3 Go to the **VoIP > SIP > SIP Service Provider** screen. Click the **Add New Provider** button to add the SIP Service Provider.



- 4 On the **Add New Provider** screen, select **Enable SIP Service Provider**.
- 5 Enter the **SIP Service Provider Name** of up to 64 printable characters except [ " ], [ ` ], [ ' ], [ < ], [ > ], [ ^ ], [ \$ ], [ | ], [ & ], or [ ; ].
- 6 Enter **SIP Proxy Server Address**, **SIP REGISTRAR Server Address**, and **SIP Service Domain** provided by your SIP service provider. Click **OK** to save your settings.

**SIP Service Provider Selection**

Service Provider Selection: ADD\_NEW

**General**

SIP Service Provider:  Enable SIP Service Provider

SIP Service Provider Name:

SIP Local Port:  (1025~65535)

SIP Proxy Server Address:

SIP Proxy Server Port:  (1025~65535)

SIP REGISTRAR Server Address:

SIP REGISTRAR Server Port:  (1025~65535)

SIP Service Domain:

### 5.6.3 Adding a SIP Account


The SIP account must be associated with the SIP service provider configured above. You may configure several SIP accounts for the same service provider. Follow the steps below to set up your SIP account:







- 1 Make sure your Zyxel Device is connected to the Internet.
- 2 Open the Web Configurator.
- 3 Go to the **VoIP > SIP > SIP Account** screen.
- 4 Click the **Add New Account** button on the **SIP Account** screen to add a SIP account and map it to a phone port.

**SIP Account** SIP Service Provider

You can make calls over the Internet using VoIP technology. For this, you first need to set up a SIP account with a SIP service provider.

The Zyxel Device uses a SIP account to make outgoing VoIP calls and check if an incoming call's destination number matches your SIP account's VoIP number. In order to make or receive a VoIP call, you need to enable and configure a SIP account and map it to a phone port. The SIP account contains information that allows your Zyxel Device to connect to your VoIP service provider.

 Add New Account

#	Enable	SIP Account	Service Provider	Account Number	Modify
1	Enabled	SIP1	Verizon	Account1	 
2	Enabled	SIP2	Verizon	Account2	 
3	Disabled	SIP3	Verizon	Account3	 

- 5 Under **General**, select **Enable SIP Account**, and then enter the **SIP Account Number**.
- 6 Under **Authentication**, enter **Username** and **Password**. Leave the other settings as default. Click **OK** to save your settings.

## 5.6.4 Configuring a Phone

You must now configure the phone port to use the SIP account you just configured.

- 1 Go to the **VoIP > Phone > Phone Device** screen.
- 2 Click the **Modify** icon of **PHONE1** to configure PHONE1 on your Zyxel Device. The following screen appears.

#	Phone ID	Internal Number	Incoming SIP Number	Outgoing SIP Number	Modify
1	PHONE1	**11	Account1	Account1	
2	PHONE2	**12	Account2	Account2	

- 3 Under **SIP1 SIP Account to Make Outgoing Call**, select **SIP1** to have the phone connected to the first phone port use the registered SIP1 account to make outgoing calls.
- 4 Under **SIP Account(s) to Receive Incoming Call**, select **SIP1** to have the phone connected to the first phone port receive phone calls for the SIP1 account. Click **OK** to save your changes.

The screenshot displays the 'Phone Device Edit' configuration page. It is divided into three main sections:

- SIP Account to Make Outgoing Call:** This section has two columns. The first column is labeled 'SIP Account' and contains a radio button selected for 'SIP1'. The second column is labeled 'SIP Number' and contains a text input field with the value 'ChangeMe'.
- SIP Account(s) to Receive Incoming Call:** This section also has two columns. The first column is labeled 'SIP Account' and contains a checked checkbox for 'SIP1'. The second column is labeled 'directoryNumber' and contains a text input field with the value 'ChangeMe'.
- Immediate Dial Enable:** This section contains a checked checkbox labeled 'Immediate Dial Enable'.

At the bottom of the form, there are two buttons: 'Cancel' on the left and 'OK' on the right.

## 5.6.5 Making a VoIP Call

Follow these steps to make a phone call using Voice over IP (VoIP).

- 1 Make sure you connect a telephone to phone port 1 on the Zyxel Device.
- 2 Make sure the Zyxel Device is turned on and connected to the Internet.
- 3 Pick up the phone receiver.
- 4 Dial the VoIP phone number you want to call.

## 5.7 Device Maintenance

This section shows you how to upgrade the Zyxel Device firmware, back up the configuration and restore the Zyxel Device to its previous or default settings.

### 5.7.1 Upgrading the Firmware

Upload the router firmware to the Zyxel Device for feature enhancements.

- 1 Download the correct firmware file from the download library at the Zyxel website. The model code for the Zyxel Device in this example is v5.13(ABLZ.1) Note the model code for your Zyxel Device. Unzip the file.
- 2 Go to the **Maintenance > Firmware Upgrade** screen.
- 3 Click **Browse/Choose File** and select the file with a ".bin" extension to upload. Click **Upload**.

Firmware Upgrade is where you can update the device with newly released features by upgrading the latest firmware. You can download the latest firmware file from the manufacturer website of this device.

---

**Upgrade Firmware**

Restore Default Settings After Firmware Upgrade

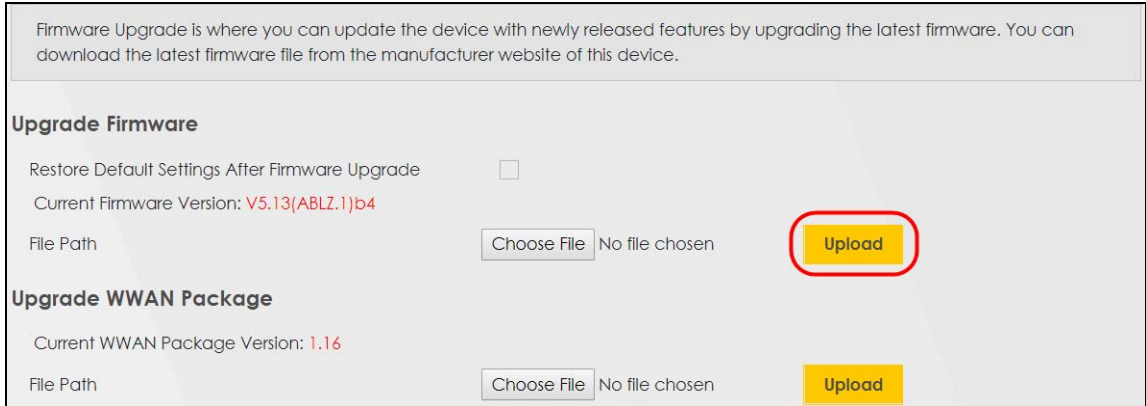
Current Firmware Version: **V5.13(ABLZ.1)b4**

File Path  No file chosen

**Upgrade WWAN Package**

Current WWAN Package Version: **1.16**

File Path  No file chosen



- 4 This process may take up to 2 minutes to finish. After 2 minutes, log in again and check your new firmware version in the **Connection Status** screen.

## 5.7.2 Backing up the Device Configuration

Back up a configuration file allows you to return to your previous settings.

- 1 Go to the **Maintenance > Backup/Restore** screen.
- 2 Under **Backup Configuration**, click **Backup**. A configuration file is saved to your computer. In this case, the **Backup/Restore** file is saved.

**Backup/Restore**

Information related to factory default settings and backup configuration are shown in this screen. You can also use this to restore previous device configurations.

Backup Configuration allows you to back up (save) the Zyxel Device's current configuration to a file on your computer. Once your Zyxel Device is configured and functioning properly, it is highly recommended that you back up your configuration file before making configuration changes.

Restore Configuration allows you to upload a new or previously saved configuration file from your computer to your Zyxel Device.

**Backup Configuration**

Click Backup to save the current configuration of your system to your computer.

**Backup**

**Restore Configuration**

To restore a previously saved configuration file to your system, browse to the location of the configuration file and click Upload.

File Path  Browse... **Upload**

**Back to Factory Default Settings**

Click Reset to clear all user-entered configuration information and return to factory default settings. After resetting, the

- Password is printed on a label on the bottom of the device, written after the text "Password".
- LAN IP address will be 192.168.1.1

Do you want to save **Backup\_Restore** (125 KB) from 192.168.1.1?

### 5.7.3 Restoring the Device Configuration

This section shows you how to restore a previously-saved configuration file from your computer to your Zyxel Device.

- 1 Go to the **Maintenance > Backup/Restore** screen.
- 2 Under **Restore Configuration**, click **Browse/Choose File**, and then select the configuration file that you want to upload. Click **Upload**.



## Backup/Restore

Information related to factory default settings and backup configuration are shown in this screen. You can also use this to restore previous device configurations.

Backup Configuration allows you to back up (save) the Zyxel Device's current configuration to a file on your computer. Once your Zyxel Device is configured and functioning properly, it is highly recommended that you back up your configuration file before making configuration changes.

Restore Configuration allows you to upload a new or previously saved configuration file from your computer to your Zyxel Device.

### Backup Configuration

Click Backup to save the current configuration of your system to your computer.

**Backup**

### Restore Configuration

To restore a previously saved configuration file to your system, browse to the location of the configuration file and click Upload.

File Path

### Back to Factory Default Settings

Click Reset to clear all user-entered configuration information and return to factory default settings. After resetting, the

- Password is printed on a label on the bottom of the device, written after the text "Password".
- LAN IP address will be 192.168.1.1
- DHCP will be reset to default setting

**Reset**

- 3 The Zyxel Device automatically restarts after the configuration file is successfully uploaded. Wait for one minute before logging into the Zyxel Device again. Go to the **Connection Status** page to check the firmware version after the reboot.

# CHAPTER 6

## App Tutorials

### 6.1 App Tutorials Overview

This part shows you how to use the MPro Mesh app to manage the Zyxel Device and the MPro Mesh network.

Note: To enjoy the latest features of the MPro Mesh app, make sure you have installed the latest version on your smartphone or tablet. Check the MPro Mesh app page on Apple App Store or Google Play Store to see if there is an update.

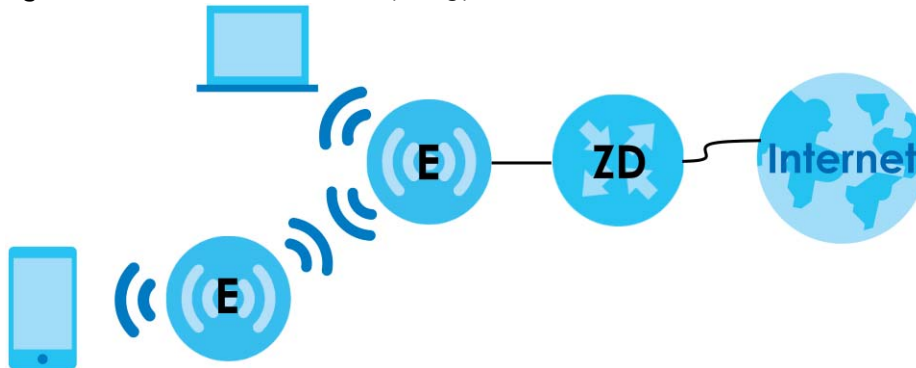
The table below explains the terms used in this chapter:

Table 26 Tutorial Terms Definition

TERM	DEFINITION
MPro Mesh Router (ZD)	Zyxel routers that support MPro Mesh
Non-MPro Mesh Router (R)	Routers that don't support MPro Mesh
MPro Mesh Extender (E)	Zyxel extenders (satellites) that support MPro Mesh

In the MPro Mesh app, the extenders are known as "satellites".

Figure 63 MPro Mesh Network Topology



See [Section 1.1 on page 19](#) to see which Zyxel Device models support MPro Mesh.

### 6.2 What You Can Do

- [Deciding the Network Controller](#)
- [Setting up an MPro Mesh Router and MPro Mesh Extender with a WiFi or Wired Connection.](#)
- [Setting up a non-MPro Mesh Router and MPro Mesh Extender with a Wired Connection.](#)

- [Finding the Best Location for the Extenders](#)
- [Checking Your Network Topology](#)
- [Changing the Default Home WiFi Network Name and Password](#)
- [Letting WiFi Clients Connect to the WiFi Network](#)
- [Blocking Internet Access at Specific Times](#)
- [Seeing Currently Connected Client Devices](#)
- [Changing the Client Device Names](#)
- [Blocking Internet Access for Specific Clients Immediately](#)
- [Setting Up the Guest WiFi Network](#)
- [Letting WiFi Clients Only Connect to the Internet Through the Guest WiFi Network](#)
- [Viewing More App Information and the Online Help](#)
- [Logging Out of the Controller Device](#)

## 6.3 MPro Mesh Network

The Zyxel Device supports MPro Mesh to manage your WiFi network. You need one router for Internet access and at least one extender, also known as a satellite, in a Mesh network. An extender increases WiFi coverage by repeating WiFi signals from the router to WiFi clients far from the router. An extender can also repeat WiFi signals from another extender to further increase WiFi coverage.

### Deciding the Network Controller

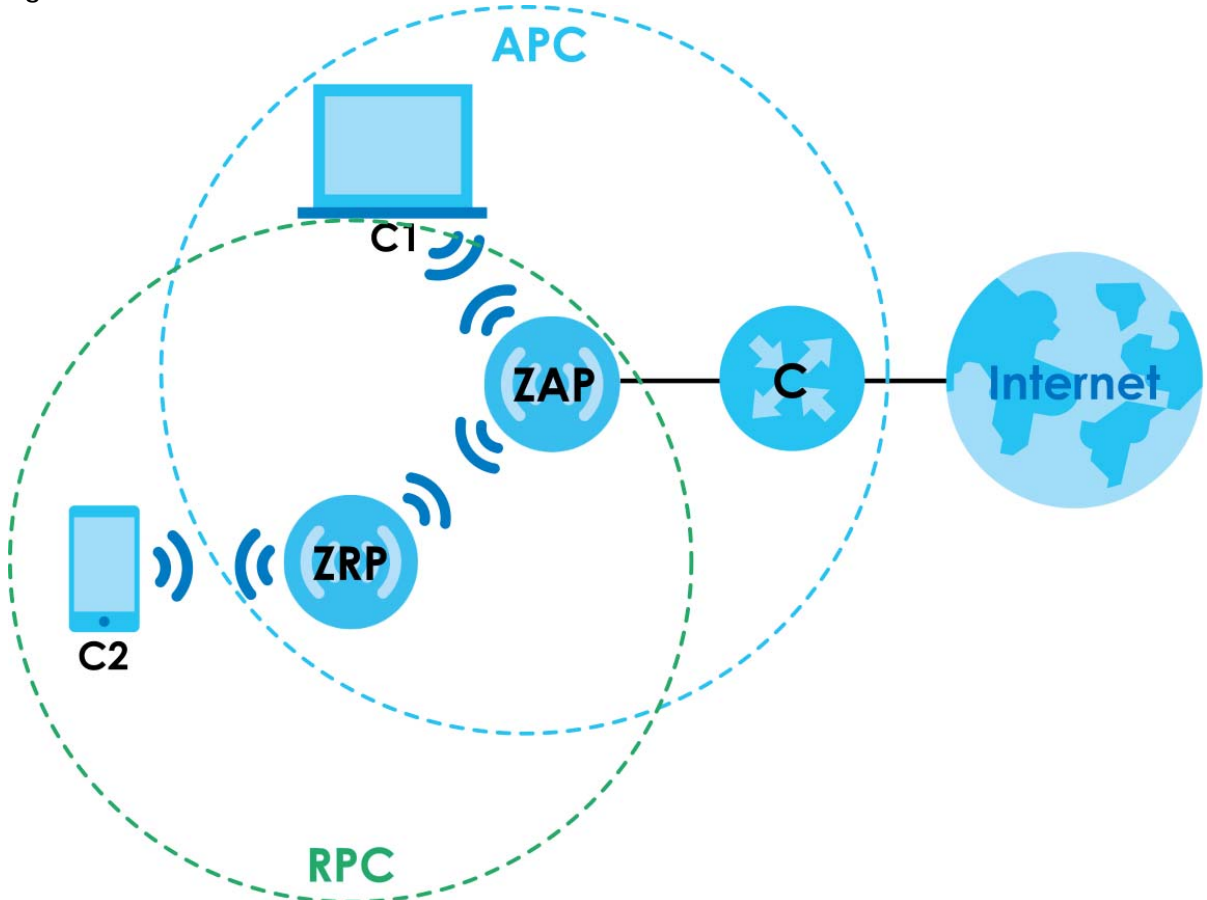
To set up an MPro Mesh network, you need a Zyxel Device that can function as a Controller. The Controller can be an MPro Mesh Router or an MPro Mesh Extender. The Controller manages and coordinates WiFi activity in a network and can steer clients to the best extender, and to the best band (2.4G/5G) to maximize network efficiency. The Controller manages the SSIDs and passwords on all access points (APs), namely your MPro Mesh Router/Extenders, in a network (auto-configuration). For example, if you change the SSID on the Controller, the SSID of each AP in the network will also change.

If your Zyxel router supports MPro Mesh, then the router is the Controller. See the Zyxel website product page.

If your router does not support MPro Mesh, then the extender is the Controller if it supports MPro Mesh. See the Zyxel website product page.

**Note:** For AP steering and band steering to work, the Controller (MPro Mesh Router/Extender) and all the APs in the network need to have the same SSID and password. Therefore, you must use the Controller to configure the SSID and password.

Figure 64 MPro Mesh Network



The following table describes the icons used in the figure.

Table 27 Icons used in MPro Mesh Network

ICON	DESCRIPTION
C	Zyxel Device – MPro Mesh Router or Non-MPro Mesh Router  Note: Your router must have an Internet connection.
ZAP	MPro Mesh Extender in AP (Access Point) mode.
ZRP	MPro Mesh Extender in Repeater mode.
C1	Client1
C2	Client2
APC	Access Point coverage area
RPC	Repeater coverage area

## AP Steering and Band Steering

Zyxel MPro Mesh supports AP steering and Band steering.

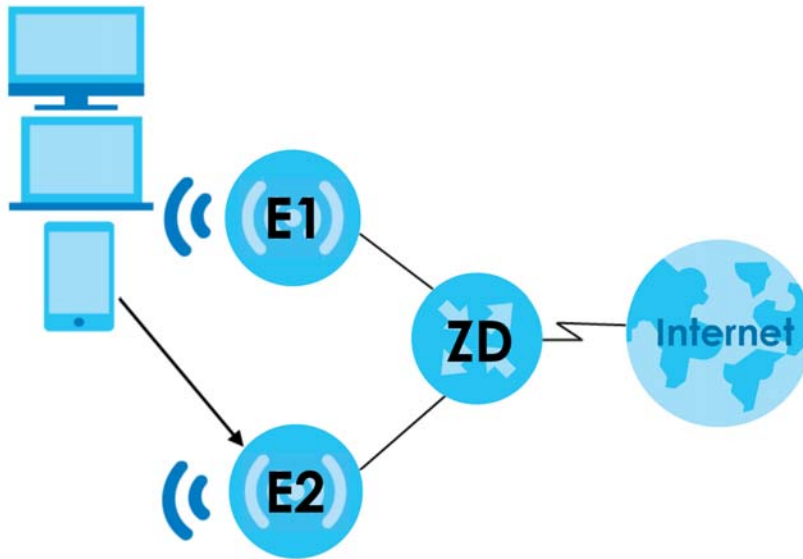
- AP steering allows WiFi clients to roam seamlessly between APs (MPro Mesh Router/Extenders) in your MPro Mesh network by using the same SSID and WiFi password. Also, AP steering monitors WiFi clients and drops their connections to optimize the extender bandwidth when the clients are idle or have a low signal. When a WiFi client is dropped, it has the opportunity to reconnect to an MPro Mesh

Extender with a strong signal.

MPro Mesh Router (**ZD**)

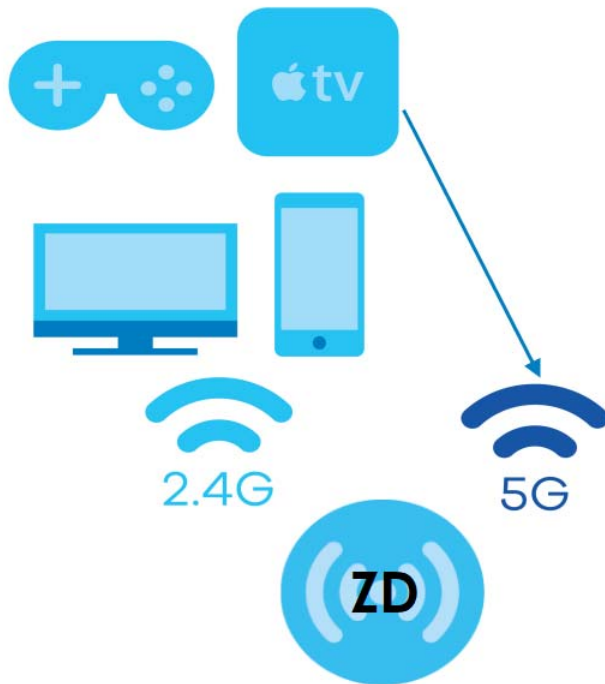
MPro Mesh Extenders (**E1**, **E2**)

**Figure 65** AP Steering Application



- Band steering allows 2.4 GHz/5 GHz dual-band WiFi clients to move from one band to another. For example, if the 2.4 GHz channel is congested, WiFi clients that support 5 GHz can move to the 5 GHz band.

**Figure 66** Band Steering Application



## 6.4 MPro Mesh Network Connection

If you are setting up the MPro Mesh network with an MPro Mesh Router and an MPro Mesh Extender, you can connect your MPro Mesh Router (ZD) with an MPro Mesh Extender (E) using a WiFi or wired connection.

Figure 67 WiFi Connection

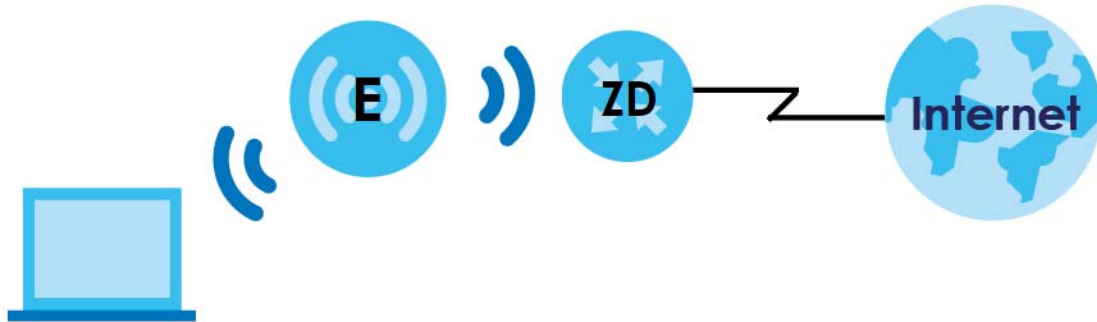
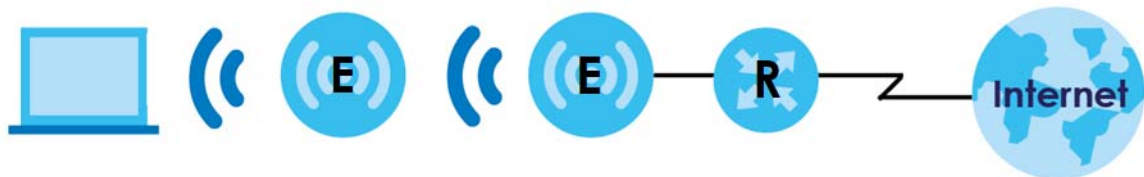


Figure 68 Wired Connection



If you are setting up the MPro Mesh network with a non-MPro Mesh Router and an MPro Mesh Extender, connect your non-MPro Mesh Router (R) with an MPro Mesh Extender (E) using a wired connection.

Figure 69 Wired Connection



### 6.4.1 Preparing your Zyxel Device

Make sure MPro Mesh is enabled on both the MPro Mesh Router and the MPro Mesh Extender. If not, follow the steps below to enable MPro Mesh.

Note: MPro Mesh is enabled on the MPro Mesh Router and MPro Mesh Extender by default.

Enable MPro Mesh on your MPro Mesh Router:

- 1 In **Network Setting** > **Wireless** > **MESH**, click the switch button to enable **MPro Mesh**.
- 2 Click **Apply**.

Enable MPro Mesh on the MPro Mesh Extender:

- 1 Turn on your MPro Mesh Extender.
- 2 Enable MPro Mesh in the MPro Mesh Extender's Web Configurator. See your MPro Mesh Extender's User's Guide for how to enable MPro Mesh.

## 6.4.2 Setting up an MPro Mesh Router and MPro Mesh Extender with a WiFi or Wired Connection

Follow the steps below to set up your MPro Mesh Router with an MPro Mesh Extender.

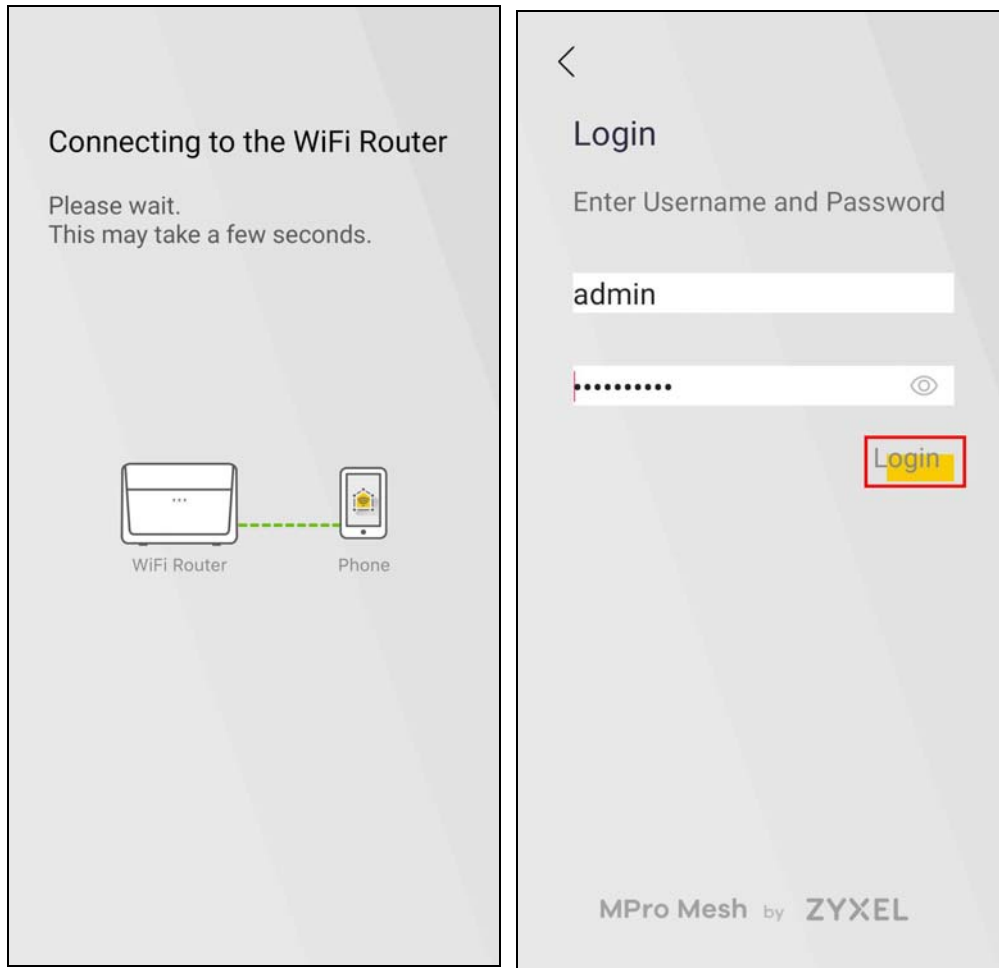
Table 28 Device Roles

DEVICE	ROLE
MPro Mesh Router (ZD)	Internet Access & Mesh Network Controller
MPro Mesh Extender (E)	Mesh Network Repeater/AP

- 1 Turn on both devices near each other. Note the power LEDs when you're done. The power LEDs should be steady green.
- 2 Download the MPro Mesh app on your smartphone. Scan the WiFi QR code or manually enter the SSID and password to connect to the MPro Mesh Router WiFi network. The QR code, SSID and password are on the MPro Mesh Router back label.

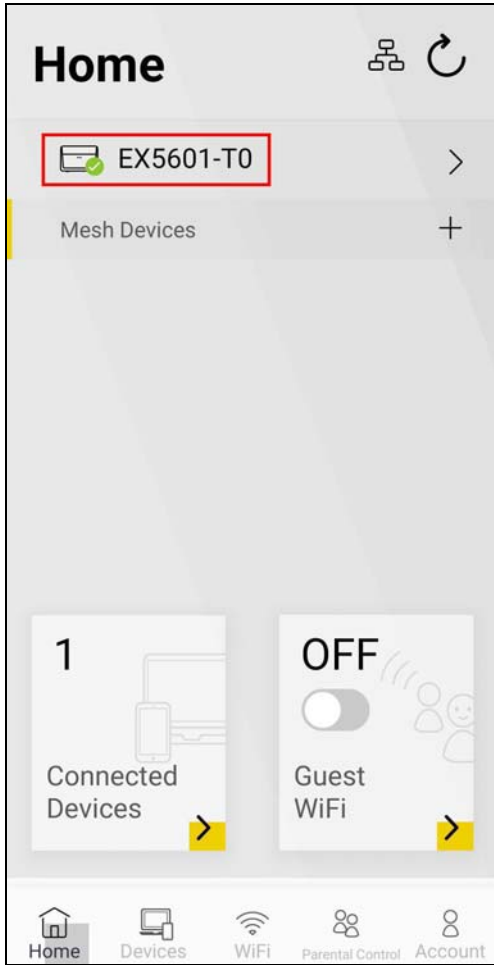


- 3 Open the MPro Mesh app. Enter the user name and password to log in to the MPro Mesh Router (Controller). The default **User Name** and **Login Password** are on the MPro Mesh Router back label. Tap **Login**.

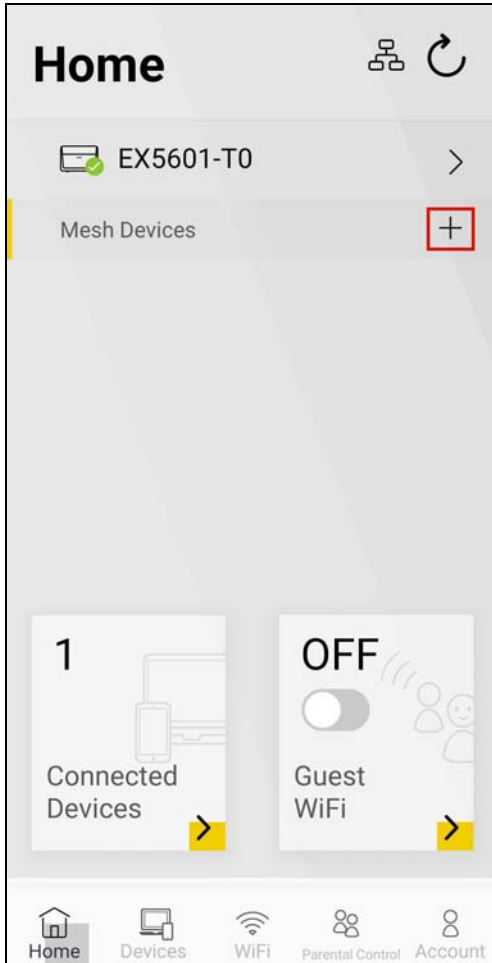


- 4 The **Home** screen displays. The Controller (MPro Mesh Router) displays on top of the **Home** screen.

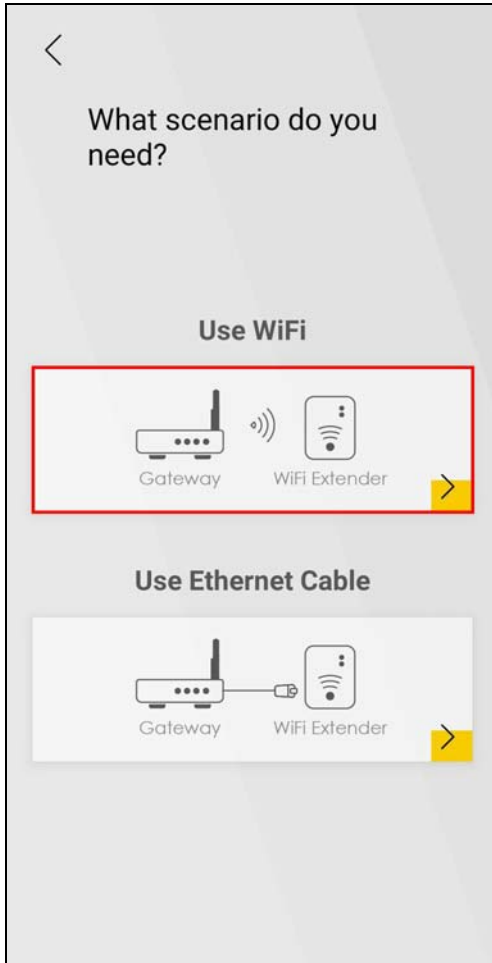




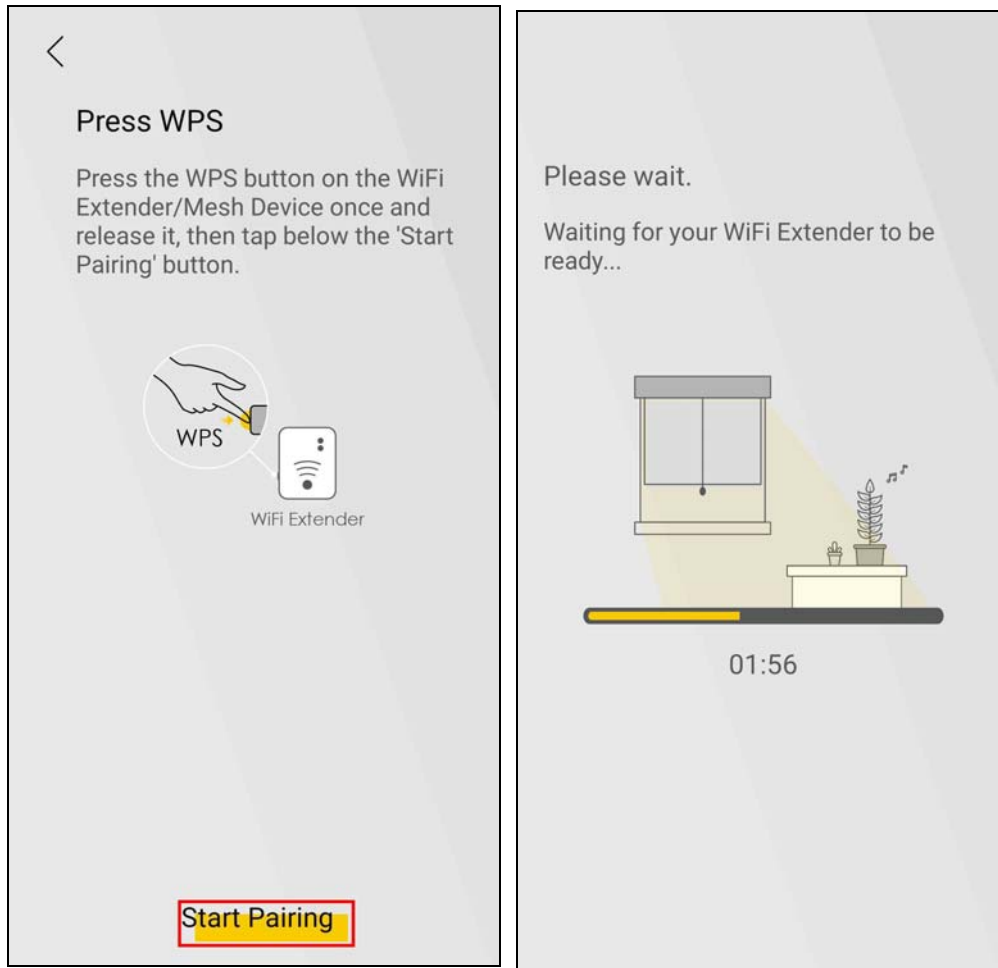
- 5 Tap the Add (+) icon in the **Mesh Devices** field to add an MPro Mesh Extender to the Mesh network.



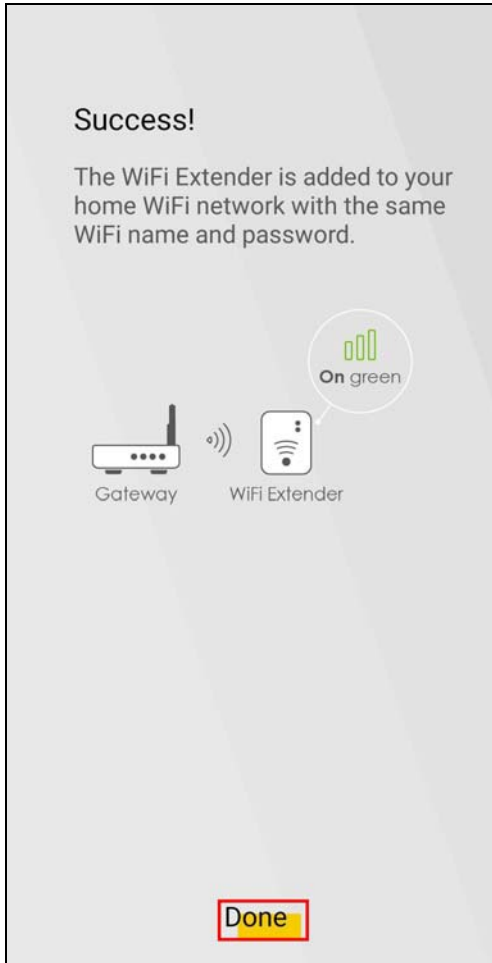
- 6 Select a connection scenario to pair the MPro Mesh Extender to the MPro Mesh Router (Controller). In this example, select the **Use WiFi** scenario.



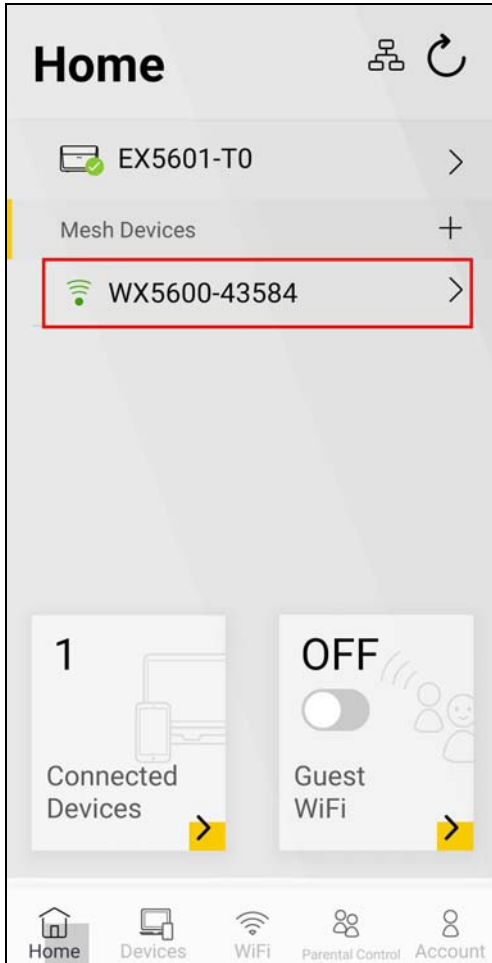
- 7 Follow the instructions and tap the WPS button on the MPro Mesh Extender. Within 2 minutes, tap **Start Pairing** to start pairing the MPro Mesh Extender to the MPro Mesh Router (Controller). A 2-minute countdown starts after you tap **Start Pairing**.



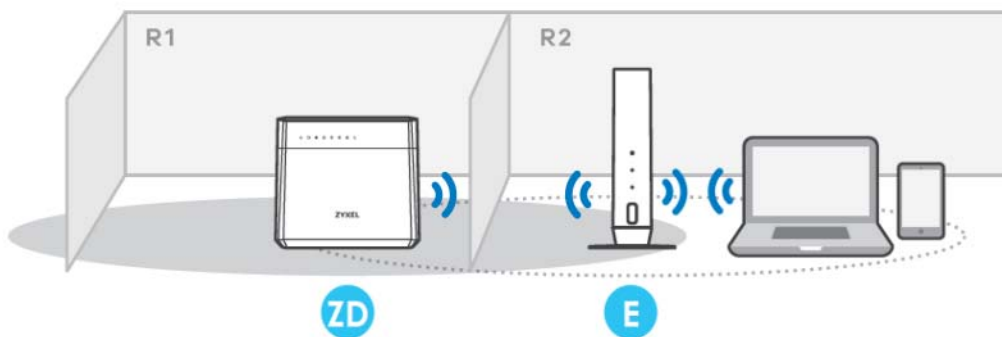
- 8 The following screen displays when the pairing process is done. Tap **Done** to finish pairing.



- 9 You can now check and manage the paired MPro Mesh Extender on the **Home** screen.



- 10 Place the MPro Mesh Extender where you need to extend WiFi coverage. Use the app to see if the extender is too far from the router; see [Section 6.5 on page 150](#) for more information.



### 6.4.3 Setting up a non-MPro Mesh Router and MPro Mesh Extender with a Wired Connection

This scenario describes the process to create an MPro Mesh network with a wired connection from the non-MPro Mesh router to two extenders.

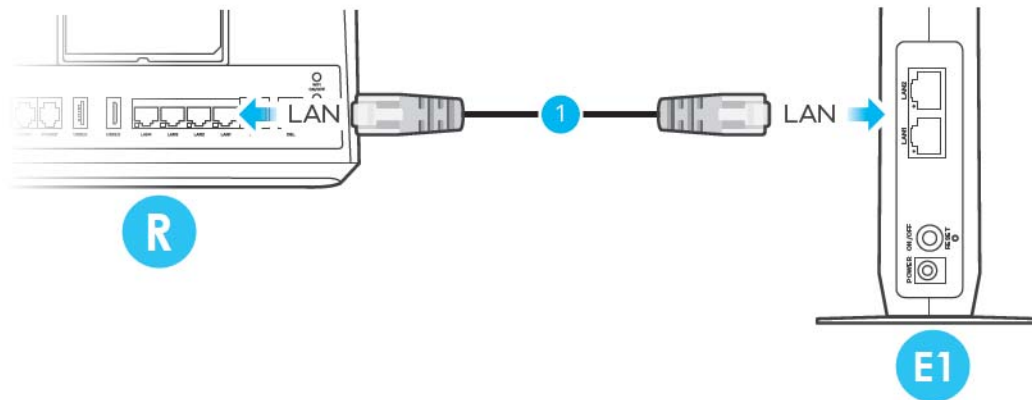
Make sure the non-MPro Mesh router is connected to the Internet. The first extender must be connected to your router using an Ethernet cable. Then, connect the second extender wirelessly to the first extender.

Follow the steps below to set up your non-MPro Mesh router with the Zyxel MPro Mesh extender.

Table 29 Device Role

DEVICE	ROLE
Non-MPro Mesh Router (R)	Internet Access
MPro Mesh Extender 1 (E1)	Mesh Network Controller & Repeater/AP
MPro Mesh Extender 2 (E2)	Mesh Network Repeater/AP

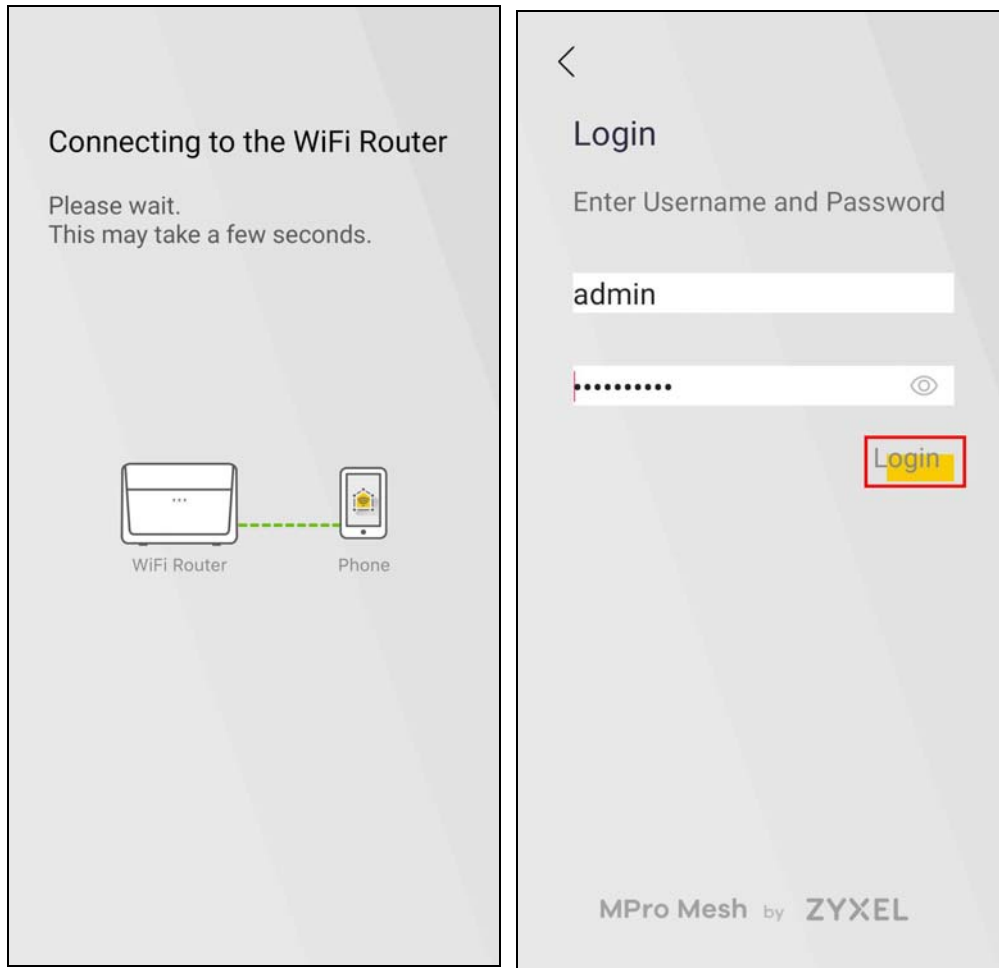
- 1 Turn on the router. Note the power LEDs when you're done.
- 2 Connect an Ethernet cable from the router to Extender 1. Place Extender 1 where you want WiFi coverage.



- 3 Download the MPro Mesh app on your smartphone. Scan the WiFi QR code or manually enter the SSID and password to connect to Extender 1 (Controller) WiFi network. The QR code, SSID and password are on Extender 1 back label.

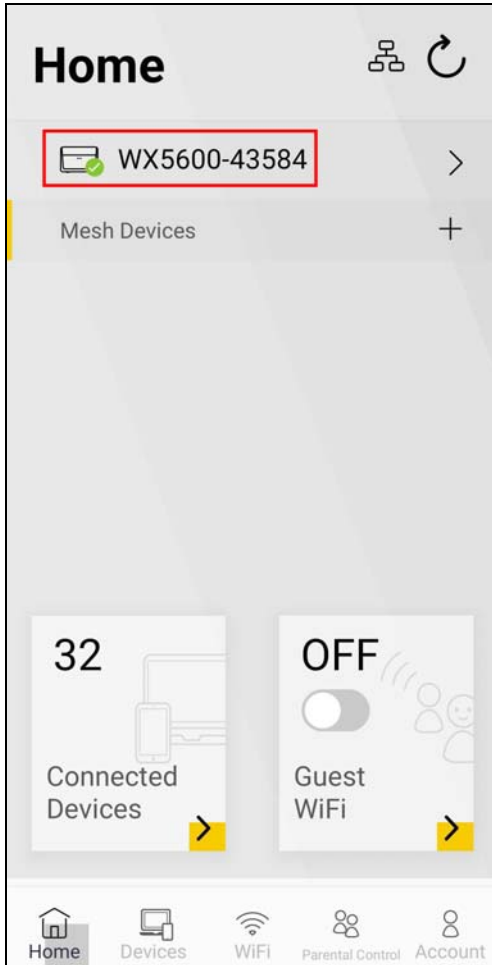


- 4 Open the MPro Mesh app. Enter the user name and password to log in to Extender 1 (Controller). The default **User Name** and **Login Password** are also on the Extender 1 back label. Tap **Login**.

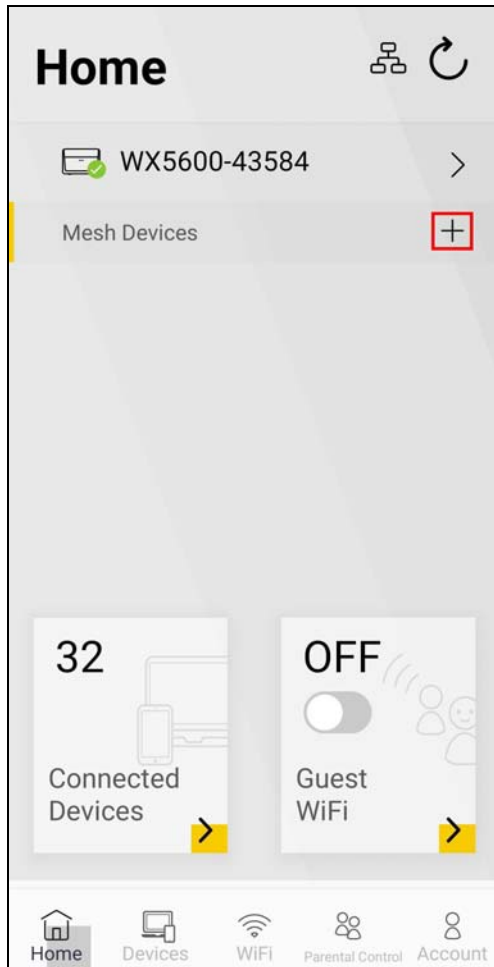


- 5 The **Home** screen displays. The Controller (Extender 1) displays on top of the screen.

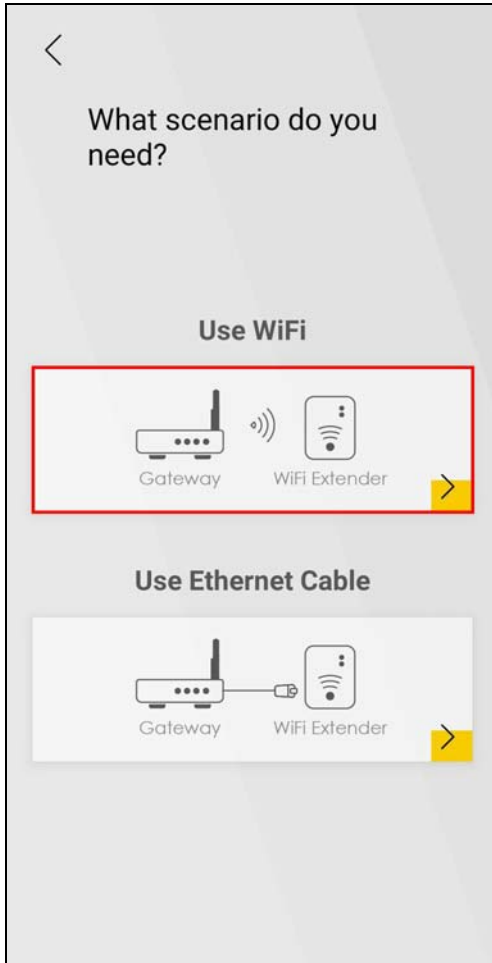




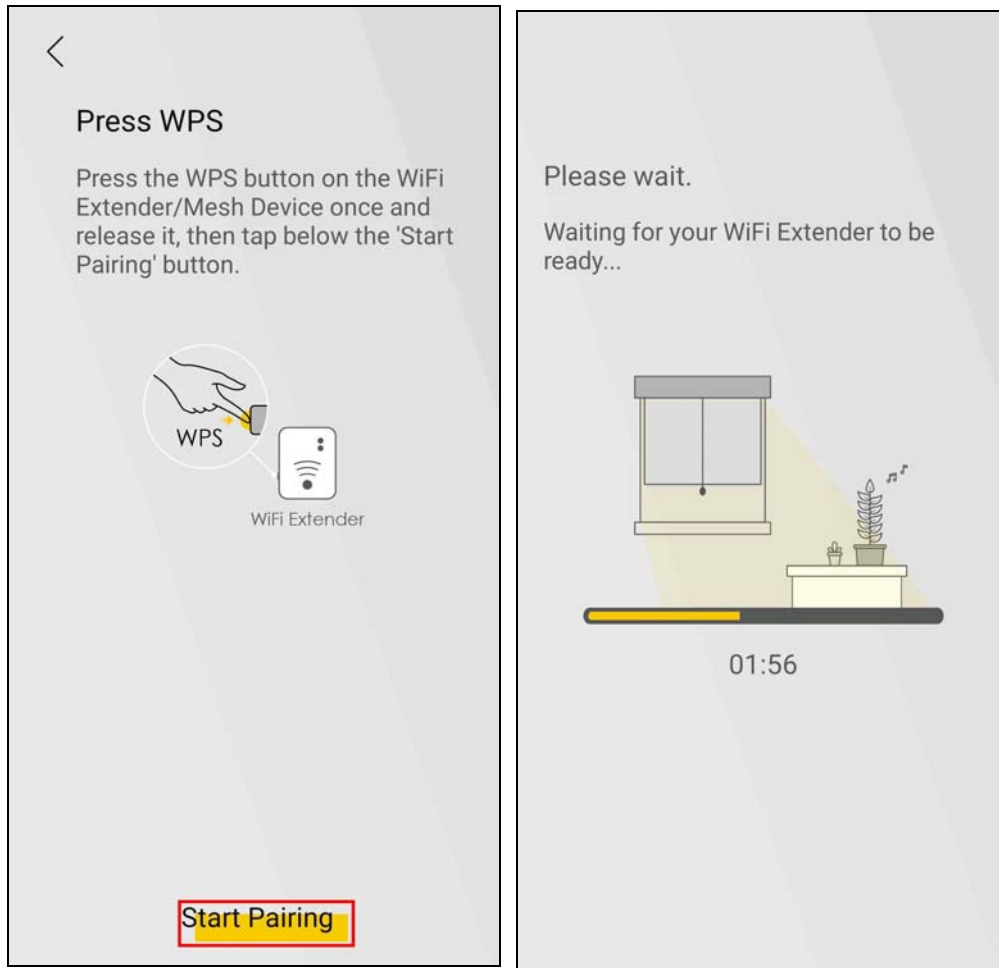
- 6 Tap the Add (+) icon in the **Mesh Devices** field to add Extender 2 to the Mesh network.



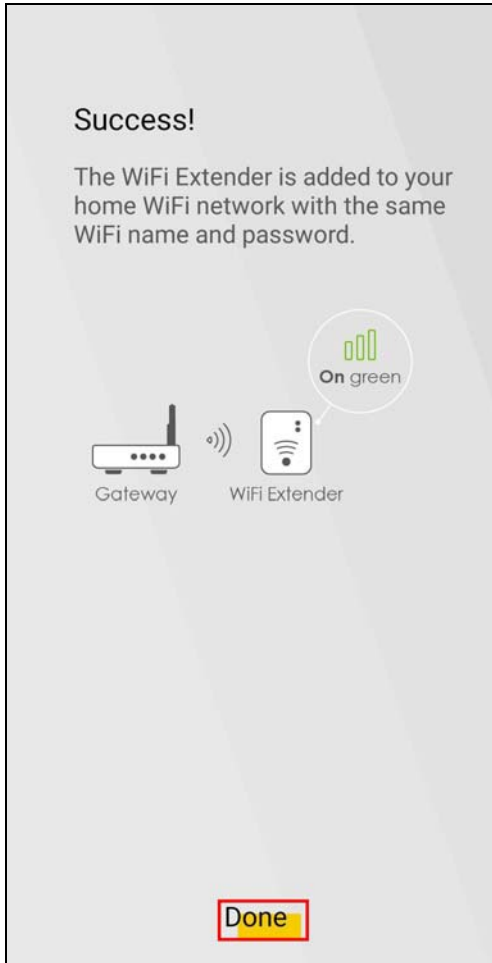
- 7 Select a connection scenario to pair Extender 2 to Extender 1 (Controller). In this example, select the **Use WiFi** scenario.



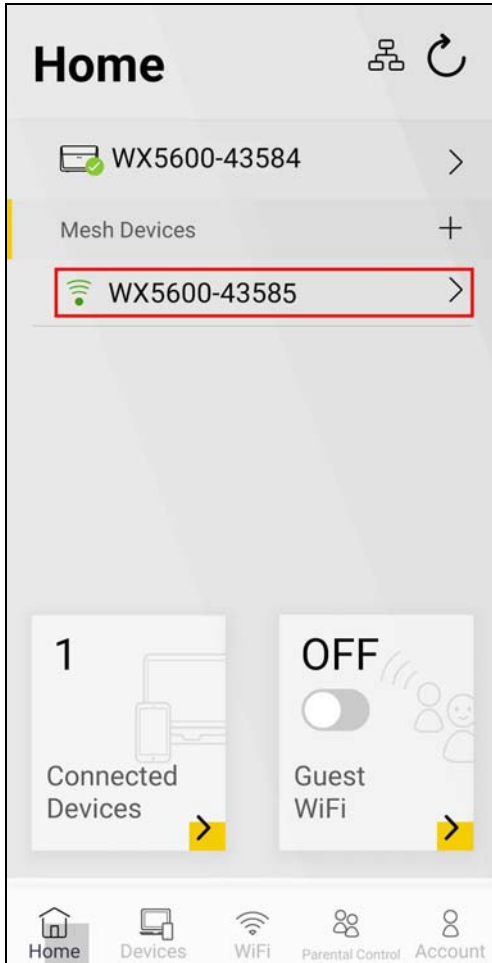
- 8 Follow the instructions and press the WPS button on the Extender 2. Within 2 minutes, tap **Start Pairing** to start pairing Extender 2 to Extender 1 (Controller). A 2-minute countdown starts after you tap **Start Pairing**.



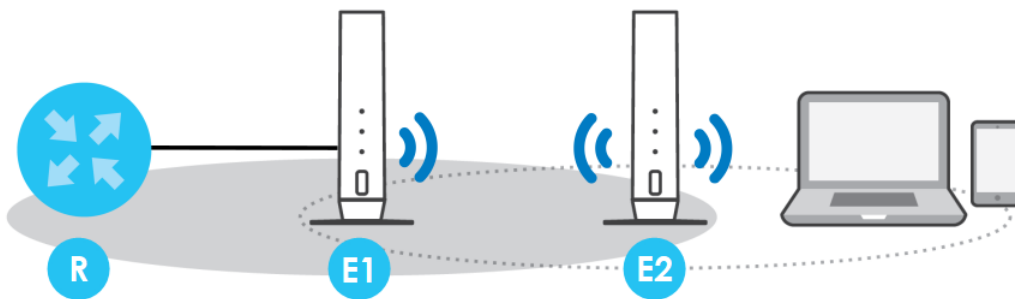
- 9 The following screen displays when the pairing process is done. Tap **Done** to finish pairing.



- 10** You can now check and manage the paired Extender 2 on the **Home** screen.



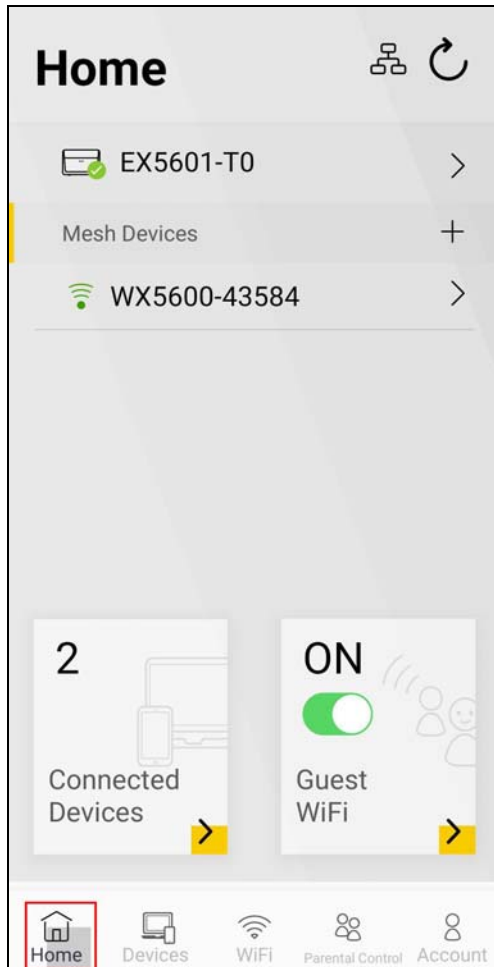
- 11 Place Extender 2 where you need to extend WiFi coverage. Use the app to see if Extender 2 is too far from Extender 1; see [Section 6.5 on page 150](#) for more information.



## 6.5 Finding the Best Location for the Extenders

Follow the steps below to check the signal icons to see which extenders are too far from or too close to the Controller. Find the best location of your extenders for a better WiFi signal.

- 1 Tap on **Home** in the navigation panel.



- 2 Look for the extender with a red WiFi signal icon (📶) or amber WiFi signal icon (📶) in front of it. Move the extender closer to or farther from the Zyxel Device according to the WiFi signal icon. See the link quality table below.
- 3 Tap the refresh button (🔄) at the top right corner to check the updated status of your extenders. The WiFi signal icons in front of your extenders should be green (📶) if they're placed in appropriate locations. See the table below for the Zyxel Device connection status.

Table 30 Link Quality







ICON	CONNECTION TYPE	CONNECTION STATUS	ACTION TO DO
	Wired	Wired Connection	None.
	Wireless	Good to Go	None.
	Wireless	Too Close to the Router	Move the Extender farther away from the Router/uplink Extender.

Table 30 Link Quality

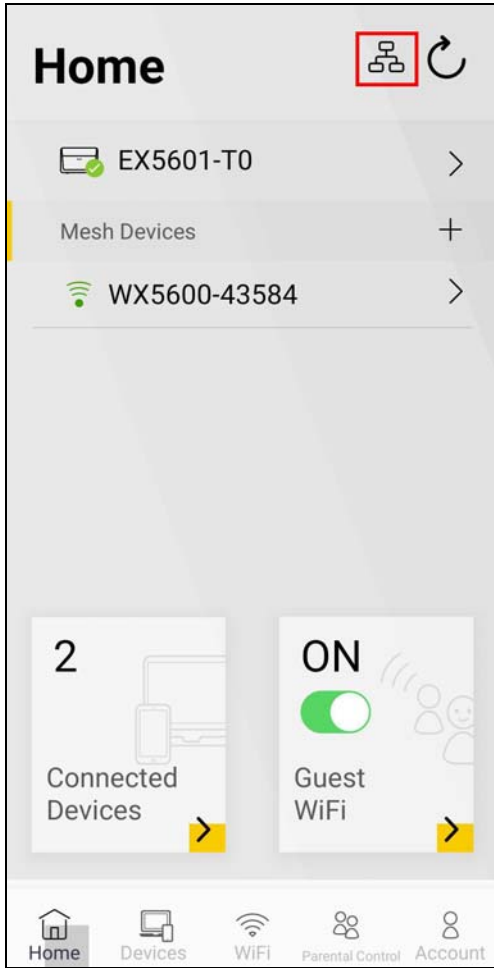
ICON	CONNECTION TYPE	CONNECTION STATUS	ACTION TO DO
	Wireless	Too Far from the Router	<ul style="list-style-type: none"> <li>• Move the Extender closer to the Router/uplink Extender.</li> <li>• Avoid obstacles, such as walls or doors in between.</li> </ul>
	Wired/Wireless	No Connection	<ul style="list-style-type: none"> <li>• Make sure the Extender is still powered on.</li> <li>• Wired: Make sure the Extender's LAN port is correctly connected to the Router/uplink Extender's LAN port through an Ethernet cable.</li> <li>• Wireless: Move the Extender closer to the Router/uplink Extender where the Extender can receive the Router/uplink Extender's WiFi signal.</li> </ul>

## 6.6 Checking Your Network Topology

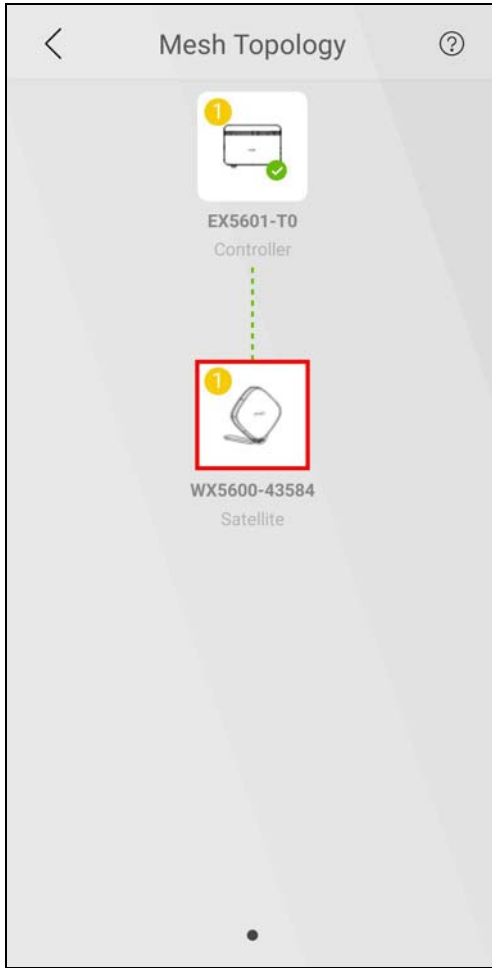
Network topology displays how your Zyxel Devices are connected in the same MPro Mesh network. An MPro Mesh network consists of a Controller and one or more extenders. Follow the steps below to see the current topology of your MPro Mesh network and the status of the Zyxel Devices in this network.

- 1 Tap the  icon to check the MPro Mesh network topology.

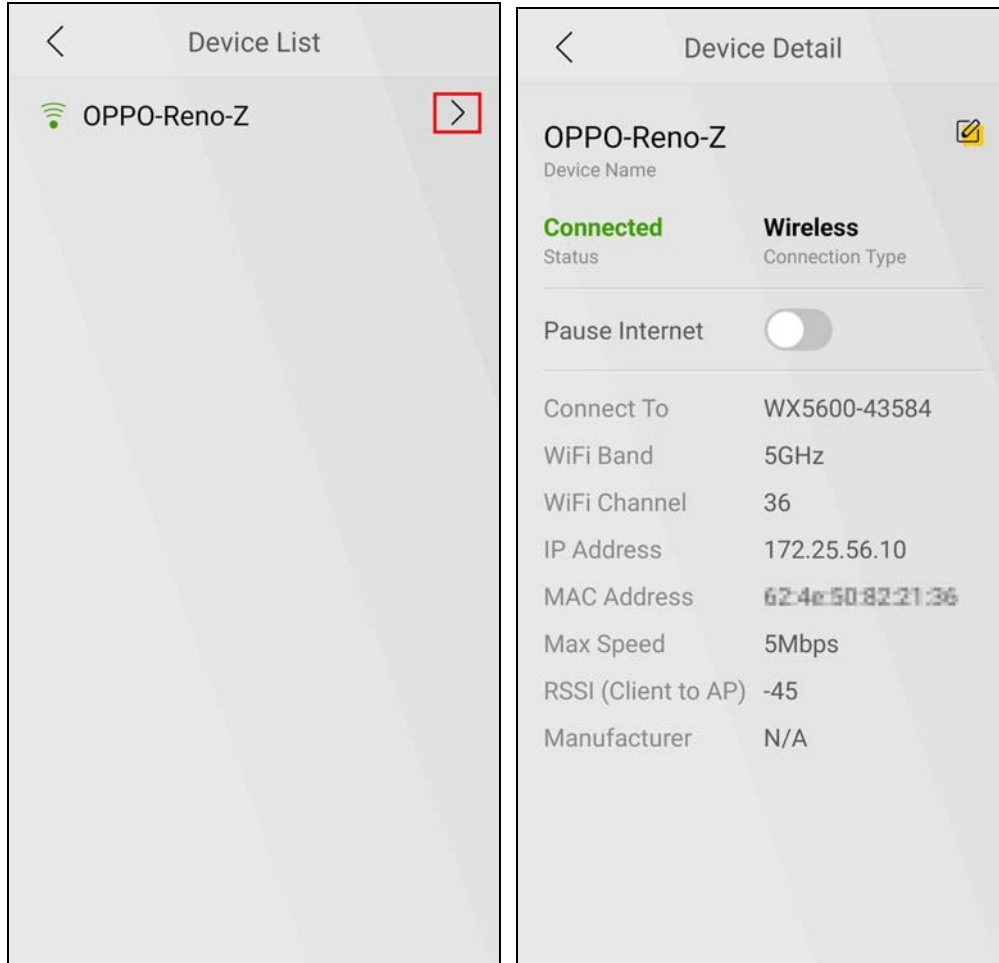




- 2 The number of connected clients display near the Zyxel Device icon. Tap a Zyxel Device icon to check and manage its connected clients.



- 3 Tap the ( > ) icon of a client to see the client's detailed information.



## 6.7 Changing the Default Home WiFi Network Name and Password

It is advisable to change the default WiFi settings as they are printed on the label on the Controller. Note that you need to reconnect your phone to this network with the new settings.

### Changing Home WiFi Settings

Change the SSID and key for your Home WiFi for better security.

Use the following parameters to change the Home WiFi SSID and key.

For the SSID, you can use 1 – 32 alphanumeric (0-9, a-z, A-Z), single-byte special characters and spaces.

For the WiFi password, you can use 8 – 63 alphanumeric (0-9, a-z, A-Z) and single-byte special characters and spaces.

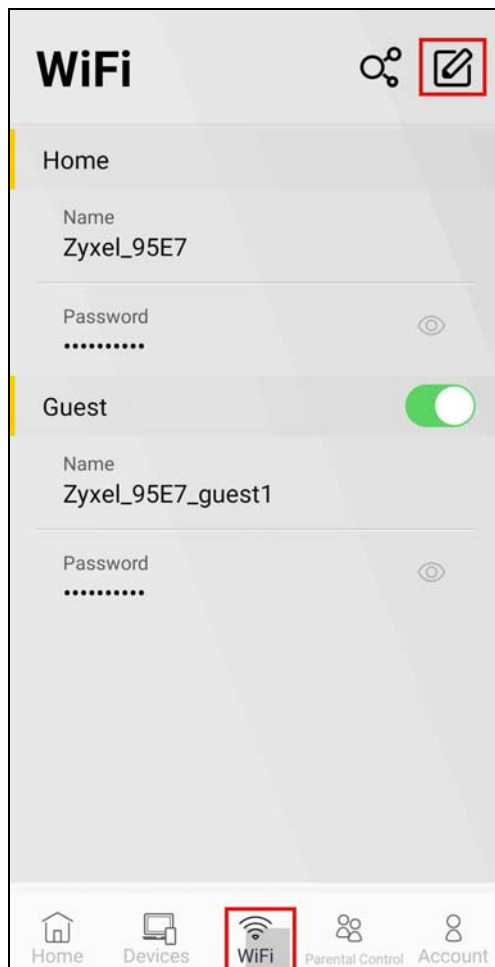
Table 31 Home WiFi Settings Parameters Example


HOME WIFI	
SSID	Company
Password	company123

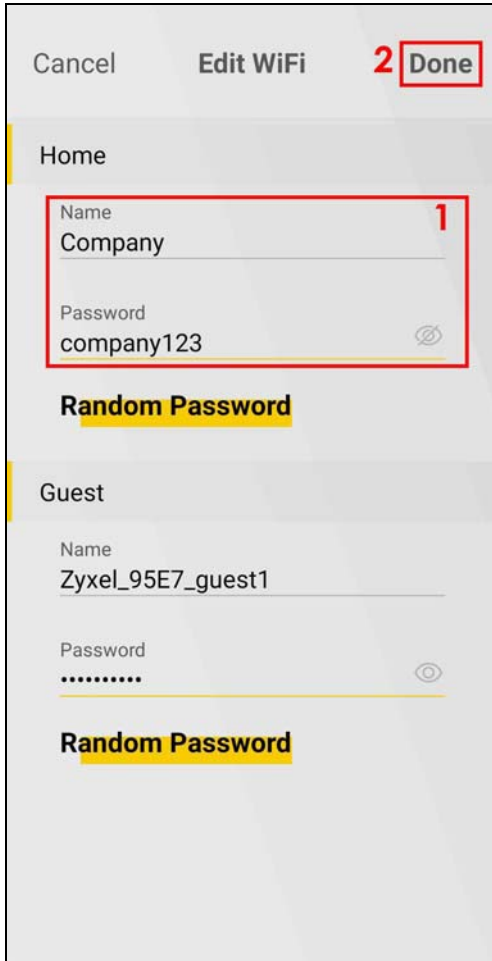
## Setting Up Home WiFi

Follow the steps below to change your Home WiFi settings.

- 1 Tap the **WiFi** icon in the navigation panel.



- 2 Tap the edit icon (  ) to edit the Home WiFi network SSID and password using the parameters given above. If you want to use a randomly generated password instead, tap **Random Password** to have the MPro Mesh app generate a random password for this WiFi network. Click **Done** to save and apply the changes.

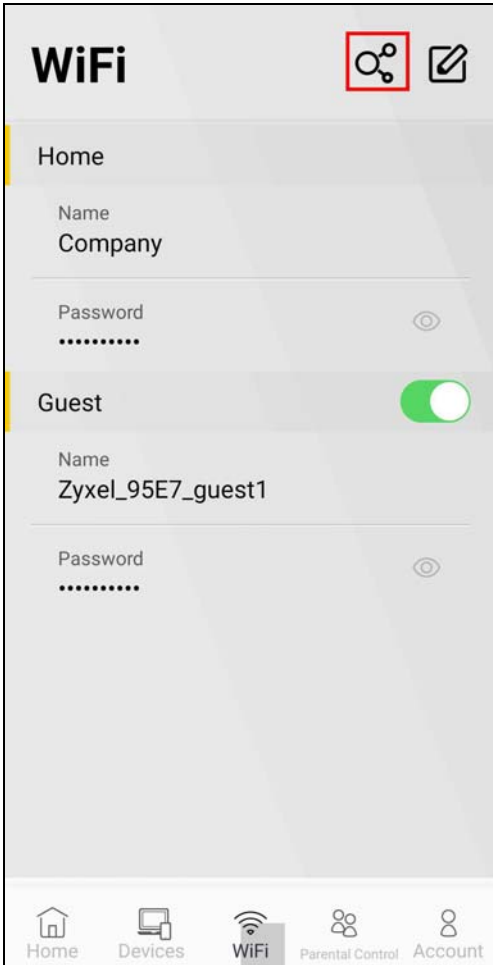


Note: It takes 2-3 minutes for the Zyxel Device to apply the new WiFi settings to the whole MPro Mesh network. You will need to reconnect to the WiFi network using the new SSID and password.

### 6.7.1 Letting WiFi Clients Connect to the WiFi Network

Take a screenshot of the QR code and share it with the WiFi clients that you want to access the WiFi network. Note that these WiFi clients can also access other devices such as servers with wired connections to the router.

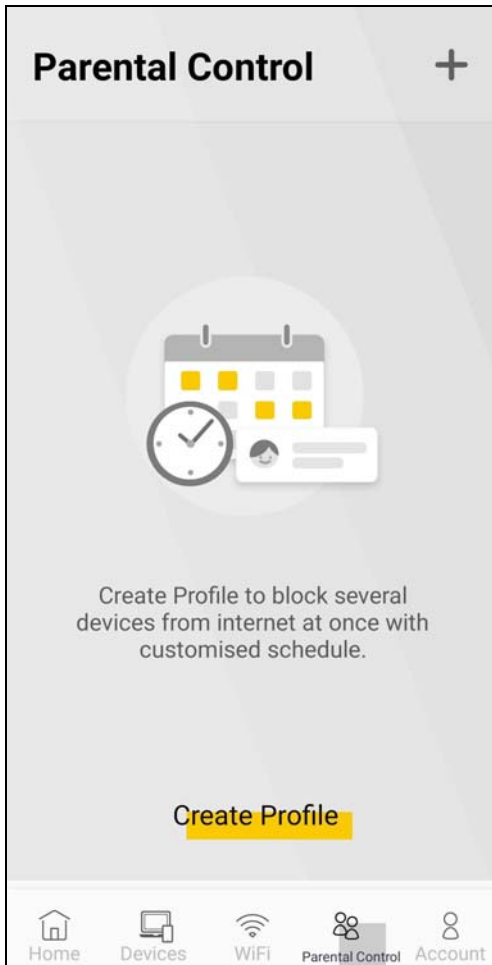
- 1 Tap the (📄) icon to show the QR code for connecting to the Zyxel Device Home WiFi. Scan the QR code with your device to connect to the Home WiFi network.



## 6.8 Blocking Internet Access at Specific Times

Use the **Parental Control** screen to configure Internet access schedule profiles to limit the days and times current client devices can access the Internet. You can create up to 20 schedules in a profile. Clients in a profile will be blocked from the Internet during the time periods you schedule.

Note: A client device can only be in one profile.



Use the following parameters to configure your parental control profile.

For the profile name, you can use 1 – 20 alphanumeric (0-9, a-z, A-Z), single-byte special characters except [ " ], [ ` ], [ ' ], [ < ], [ > ], [ ^ ], [ \$ ], [ | ], [ & ], or [ ; ]. Spaces are allowed.

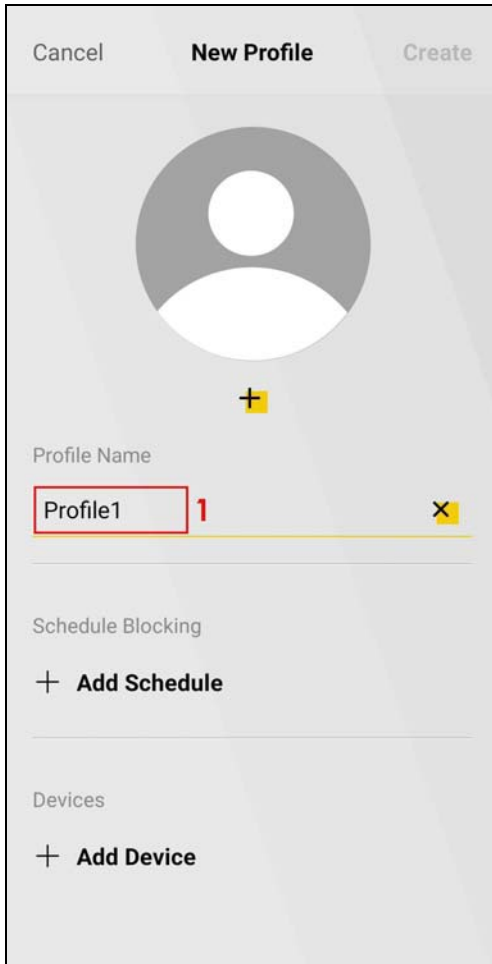
Table 32 Parental Control Profile Example

PROFILE NAME	START TIME	END TIME	REPEAT DAYS
Profile1	23:00	23:59	Monday to Friday
	00:00	6:30	Monday to Friday

### Creating a Parental Control Profile

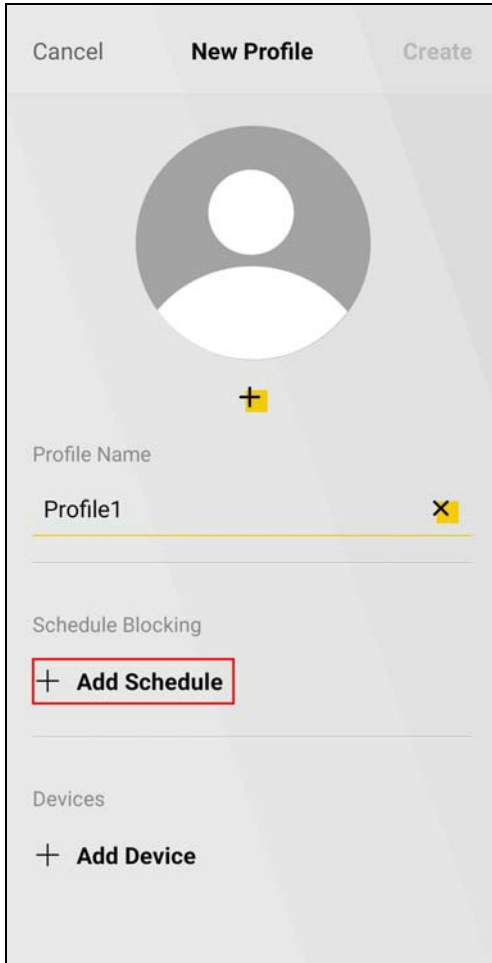
Follow the steps below to create a parental control profile.

- 1 Tap **Parental Control** in the navigation panel.
- 2 Tap the add icon (+) or **Create Profile** to create a parental control profile.
- 3 Enter the **Profile Name**.



- 4 Tap **Add Schedule** to add a schedule for this profile.





- 5 Configure the first schedule using the parameters given above. Tap **Save**.

Cancel    **Add Schedule**    **Save**

Block from Internet

Start Time    22 : 59  
                  23 : 00  
                  00 : 01

End Time      22 : 58  
                  23 : 59  
                  00 : 00

Repeat Days

Monday       

Tuesday      

Wednesday   

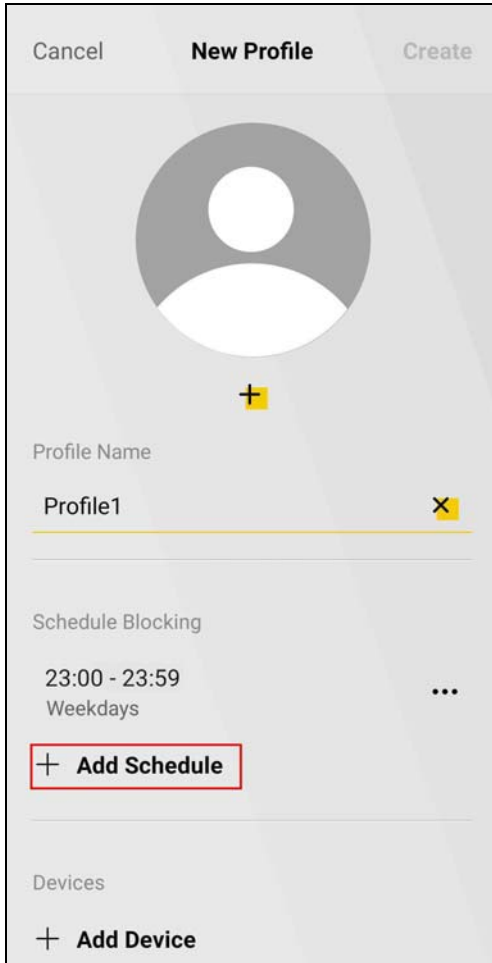
Thursday     

Friday        

Saturday     

Sunday       

- 6 Tap **Add schedule** to add the second schedule.



- 7 Configure the second schedule using the parameters given above. Tap **Save**.

Cancel    **Add Schedule**    **Save**

Block from Internet

Start Time    23 : 59  
00 : 00  
01 : 01

End Time    05 : 29  
06 : 30  
07 : 31

Repeat Days

Monday   

Tuesday   

Wednesday   

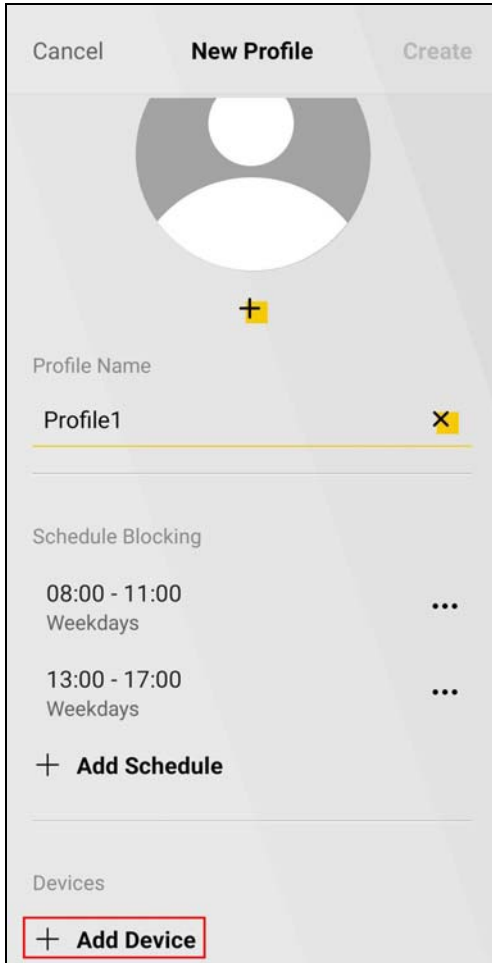
Thursday   

Friday   

Saturday   

Sunday   

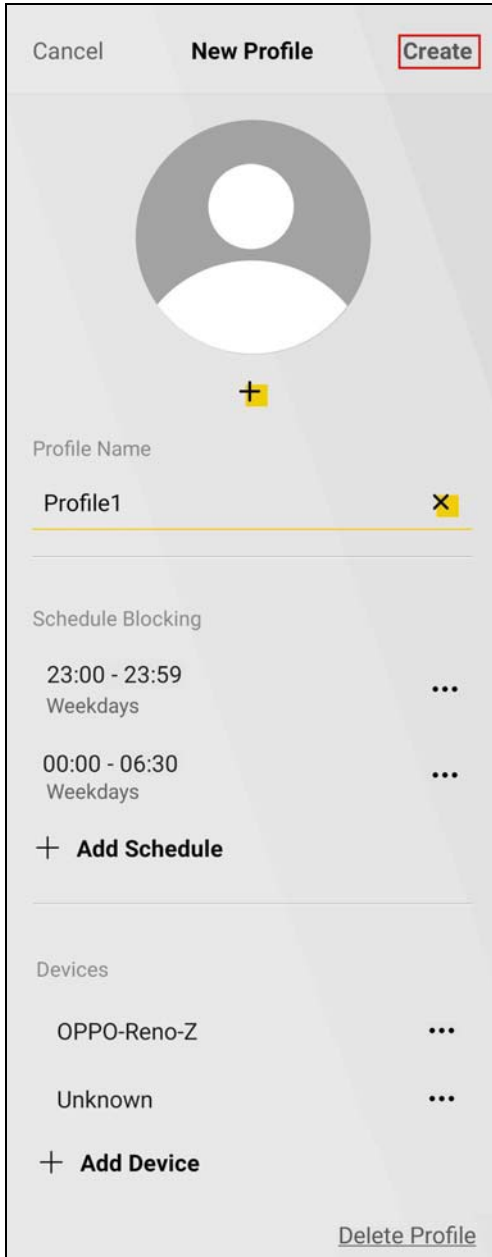
- 8 Tap **Add Device** to select the client devices for which you want to apply this profile.



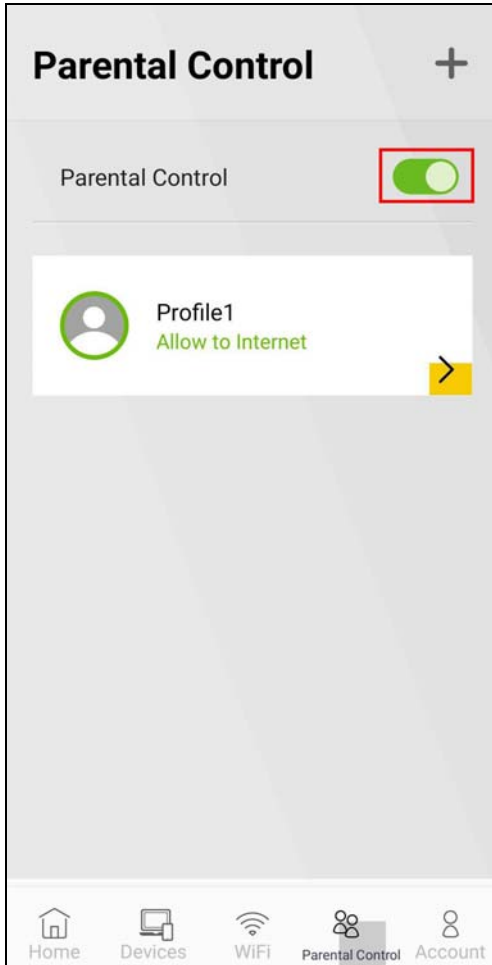
- 9 Tap the (  ) icon of the client devices you want to select. Tap **Add**.



**10** Tap **Create** to finish creating the parental control profile.



- 11** Tap the switch to enable **Parental Control**. The profiles are active when you enable **Parental Control**. If a profile is currently blocking clients from Internet access during the scheduled period, the status displays **Block from Internet**. Otherwise, it displays **Allow to Internet**.








## 6.9 Seeing Currently Connected Client Devices

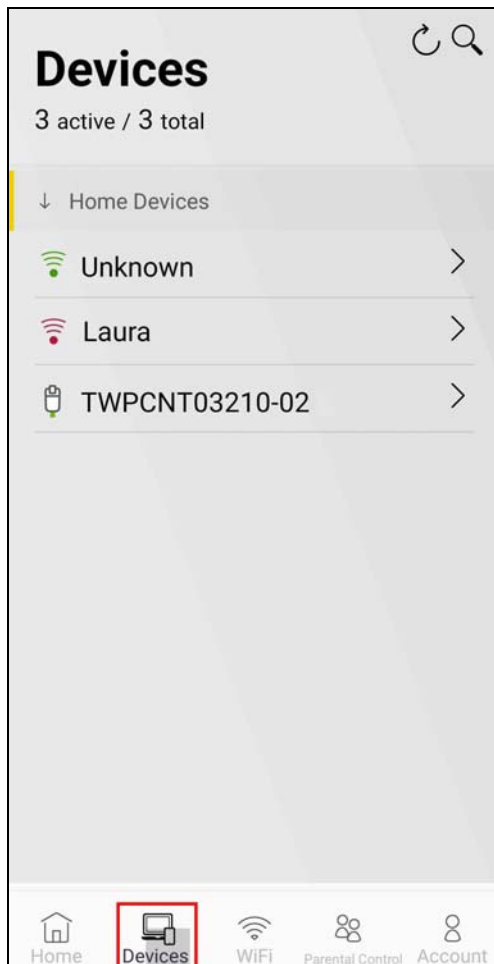
Follow the steps below to view clients that are currently connected to your MPro Mesh network and their link quality and device details, such as the IP address, MAC address, and the connection status of a client device.

- 1 Tap **Connected Devices** in the **Home** screen or **Devices** in the navigation panel to view the connected devices. It shows **Unknown** if the client device does not have a recognizable host name or if the Zyxel Device is still getting the client device information. For the client device's connection status, see the table below.

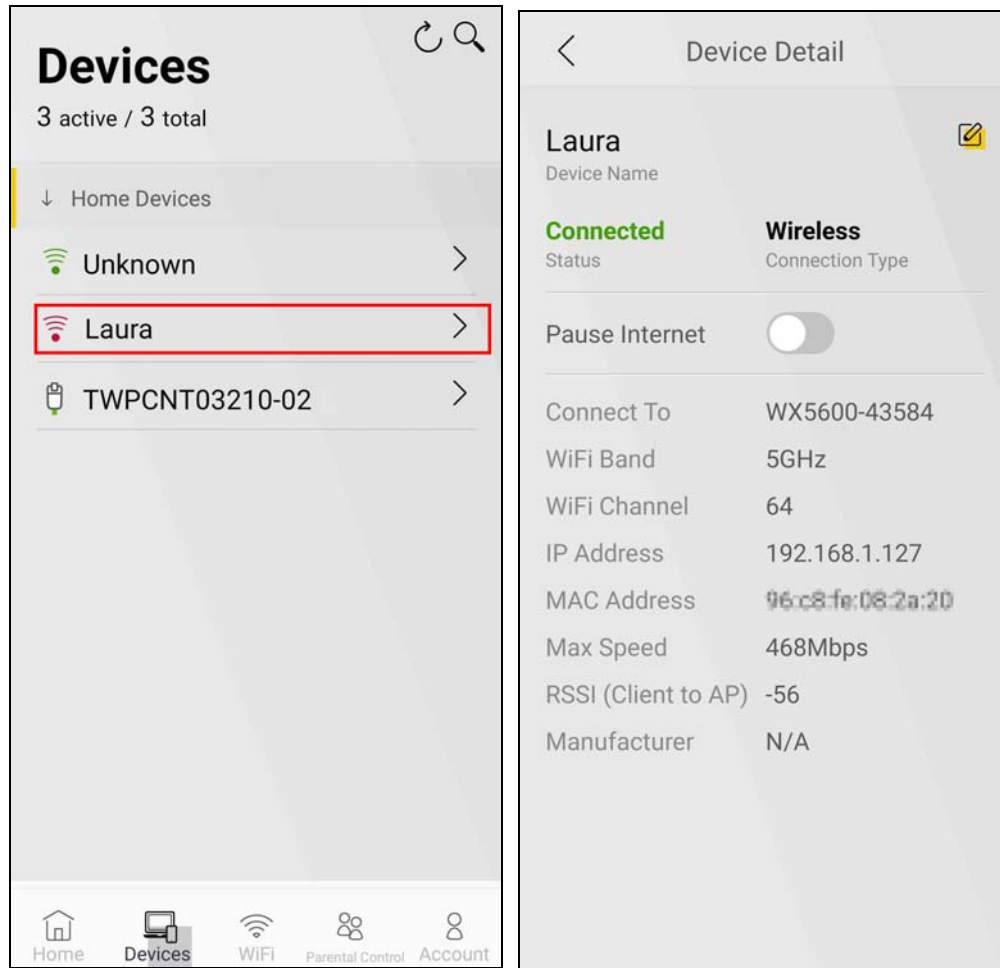


Table 33 Client Device Connection Status

ICON	CONNECTION TYPE	CONNECTION STATUS	ACTION TO DO
	Wired	Wired Connection	None.
	Wireless	Good to Go	None.
	Wireless	Too Far from the Zyxel Device	<ul style="list-style-type: none"> <li>Move the client device closer to the Zyxel Device.</li> <li>Avoid obstacles, such as walls or doors in between.</li> </ul>
	Wired/Wireless	No Connection	<ul style="list-style-type: none"> <li>Wired: Make sure the client device is correctly connected to the Zyxel Device's LAN port through an Ethernet cable.</li> <li>Wireless: Move the client device closer to the Zyxel Device where the client device can receive the Zyxel Device's WiFi signal.</li> </ul>
	Wired/Wireless	Blocked from the Internet	You have previously blocked the client device from the Internet. To resume the client device's Internet access, disable <b>Pause Internet</b> and make sure the client device is not blocked by any parental control profile. See <a href="#">Section 6.8 on page 159</a> and <a href="#">Section 6.11 on page 172</a> for more information.



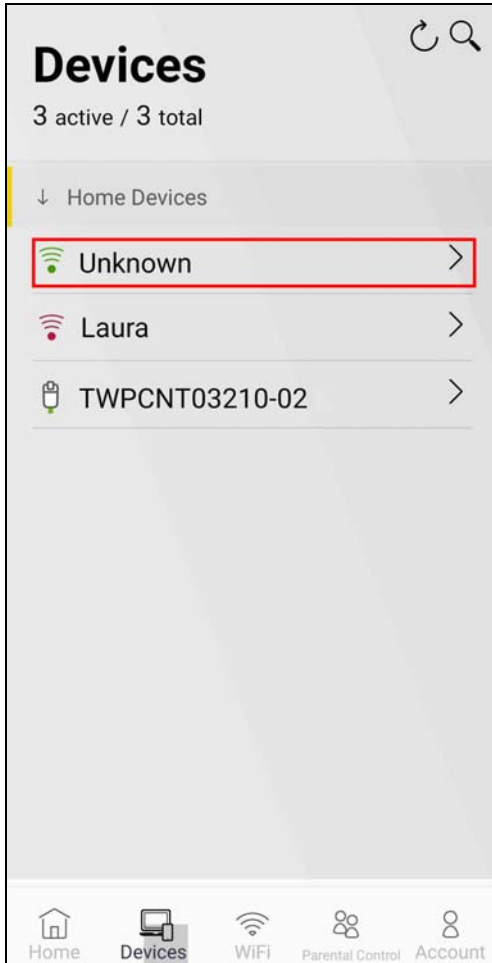
- 2 Tap to select a client device to view the device's IP address, MAC address, Internet access schedule profile, and the connection status.





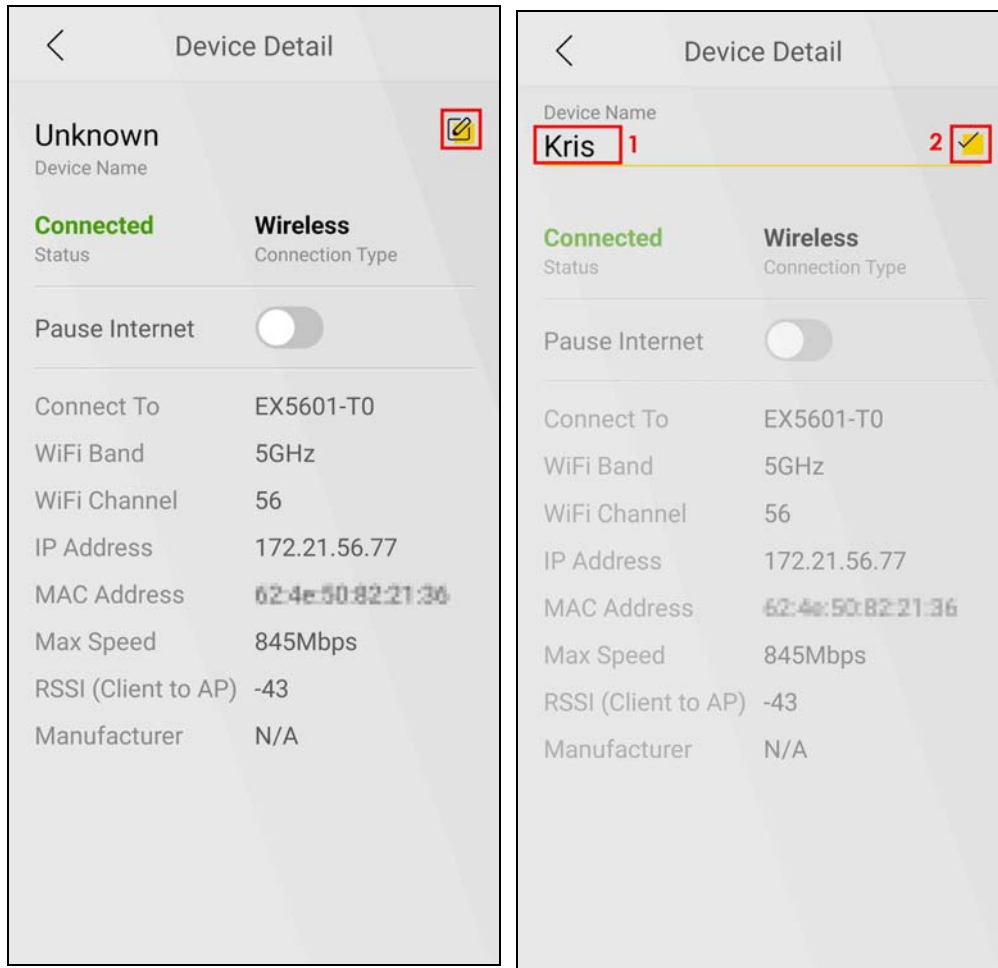
## 6.10 Changing the Client Device Names

Follow the steps below to change your client device's name displayed on the app.

- 1 Tap the **Devices** icon in the navigation panel.
- 2 Tap to select a client to go to the **Device Details** screen.



- 3 Tap the edit icon (  ) to edit the device name.
- 4 Enter a descriptive name for the device and tap the (  ) icon. You can use 1 – 20 alphanumeric (0-9, a-z, A-Z) and single-byte special characters except [ " ], [ ` ], [ ' ], [ < ], [ > ], [ ^ ], [ \$ ], [ | ], [ & ], or [ ; ]. Spaces are allowed.

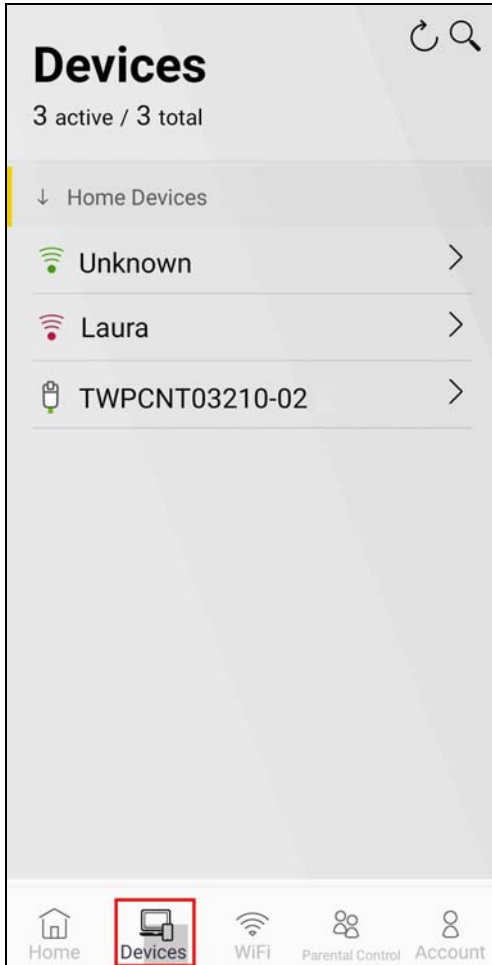




## 6.11 Blocking Internet Access for Specific Clients Immediately

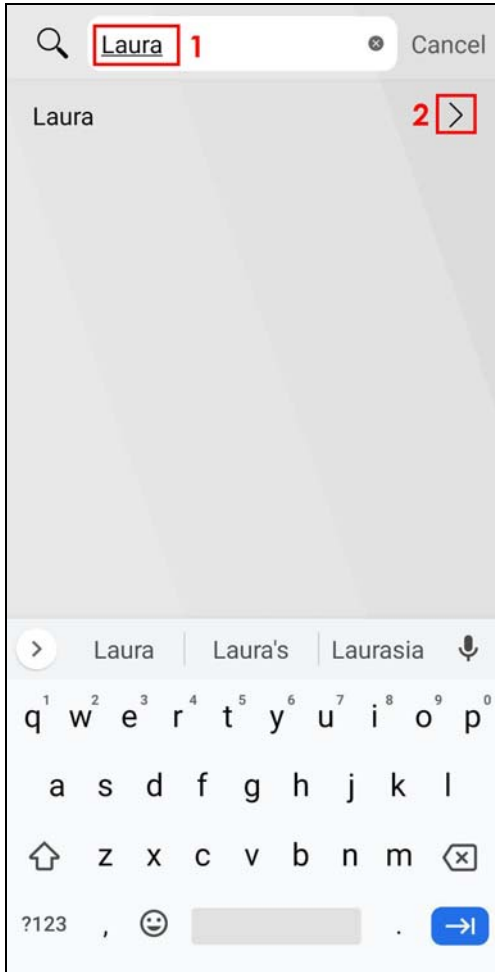
Follow the steps below to block a specific client named **Laura** from accessing the Internet using the **Pause Internet** function.

Note: If you enable **Pause Internet** for a client device, the client device will be blocked from the Internet immediately regardless of your **Parental Control** profile schedules. It will continue to be blocked until you disable **Pause Internet**.

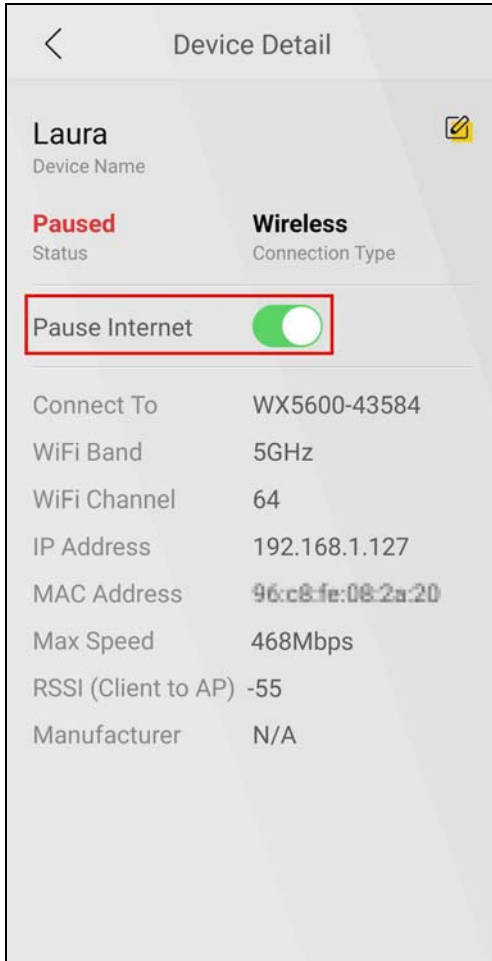
- 1 Tap the **Devices** icon in the navigation panel.



- 2 Tap the search icon (  ). Enter **Laura** in the field.
- 3 Tap the (  ) icon to show the **Device Detail** screen.



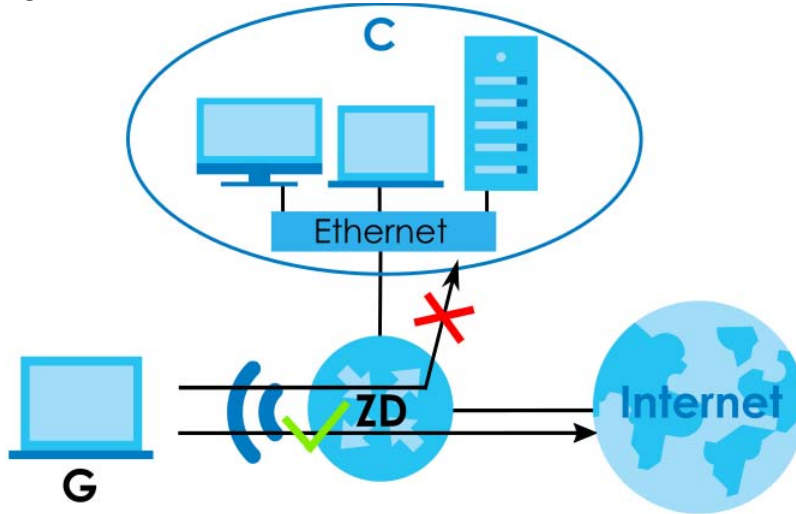
- 4 Tap to enable the switch in the **Pause Internet** field. **Laura** will not be able to access the Internet until you disable **Pause Internet**.



## 6.12 Setting Up the Guest WiFi Network

You can set up a Guest WiFi network for your Zyxel Device. Company A wants to create a different WiFi network group for different types of users as shown in the following figure. This group has its own SSID and password.

- Employees in Company A will use a general **Company** WiFi network group.
- Visiting guests will use the **Guest** WiFi network group, which has a different SSID and password. Visiting guests (**G**) can access the Internet but cannot access the company internal network (**C**) using Guest WiFi.

**Figure 70** Visiting Guests Blocked from Company Network

Use the following parameters to set up the Guest WiFi network group.

For the SSID, you can use 1 – 32 alphanumeric (0-9, a-z, A-Z), single-byte special characters and spaces. For the WiFi password, you can use 8 – 63 alphanumeric (0-9, a-z, A-Z), single-byte special characters and spaces.

Table 34 Guest WiFi Settings Parameters Example

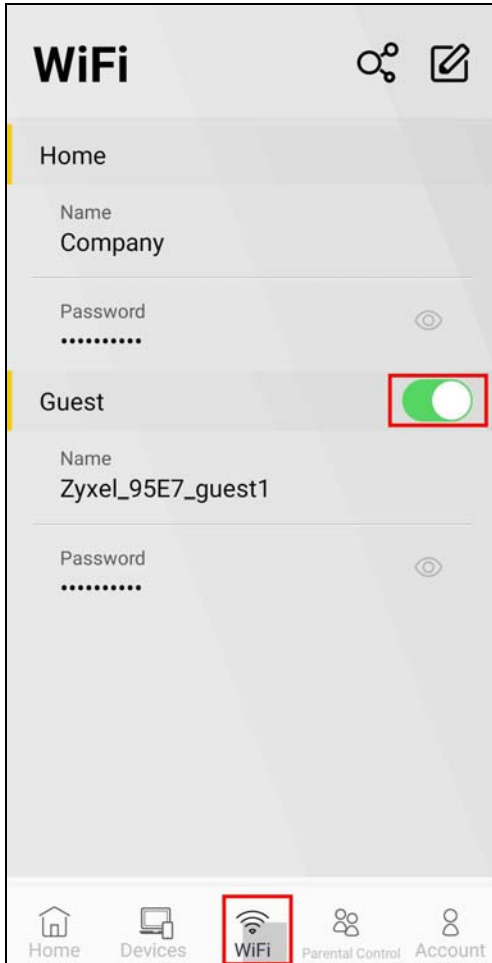
GUEST WIFI	
SSID	Guest
Password	guest123

## Setting Up Guest WiFi

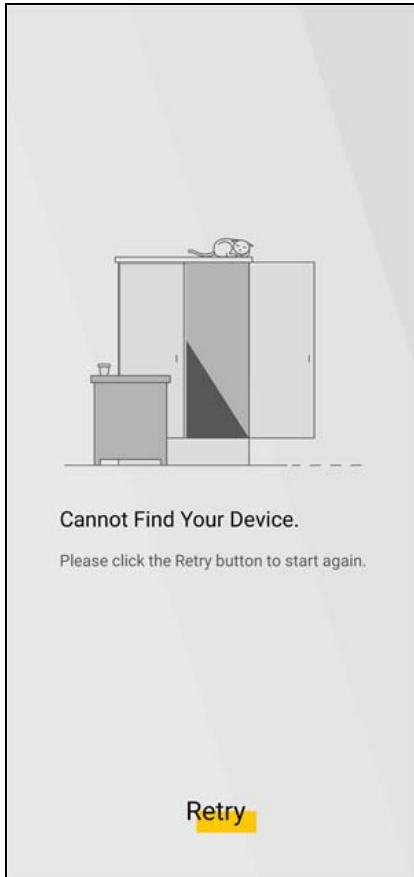
Follow the steps below to set up a Guest WiFi network group.


- 1 Tap **WiFi** in the navigation panel. Tap the switch in the **Guest** field to enable the Guest WiFi.

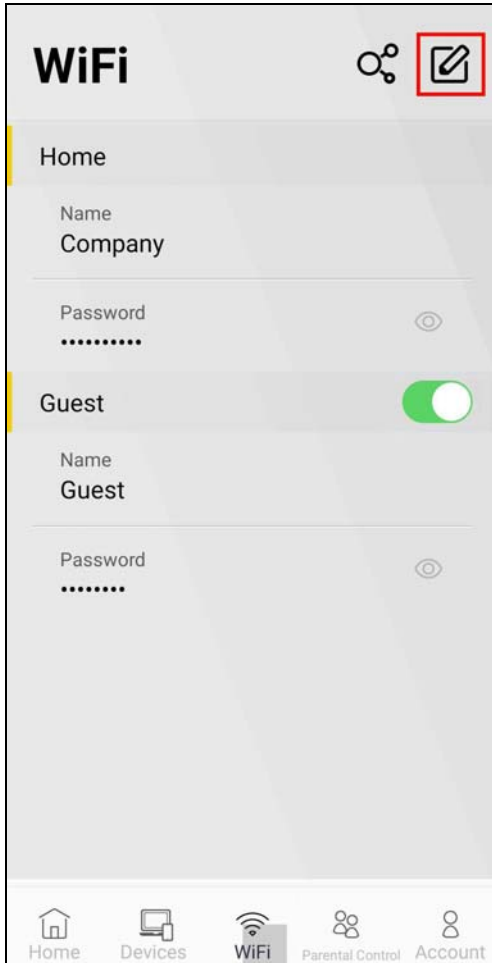




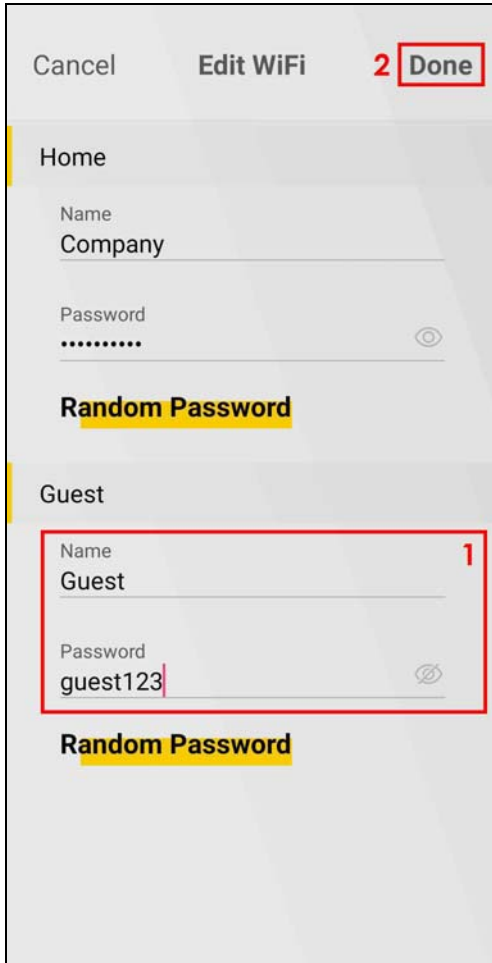
- 2 Your phone will temporarily disconnect from the Main WiFi network when you enable Guest WiFi. It takes 2 – 3 minutes for the Zyxel Device to apply the new settings to the whole MPro Mesh network. Make sure your phone reconnects to the Zyxel Main WiFi network. After your phone reconnects to the Main WiFi network, tap **Retry** to find the Zyxel Device and log in again.



- 3 Tap the edit icon (  ) to edit the Guest WiFi network.

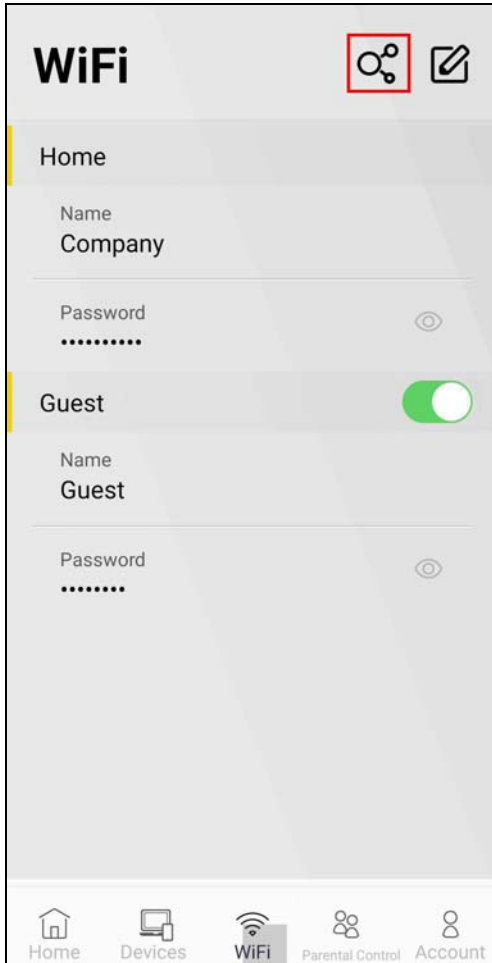


- 4 Set the Guest WiFi group SSID and password using the parameters given above. Tap **Done** to save and apply the settings. Your phone will temporarily disconnect from the Main WiFi network when you change the Guest WiFi settings. Make sure it reconnects to the Zyxel Main WiFi network.



### 6.12.1 Letting WiFi Clients Only Connect to the Internet Through the Guest WiFi Network

- 1 Tap the **WiFi** icon in the navigation panel. Tap the (📶) icon to show the QR code.



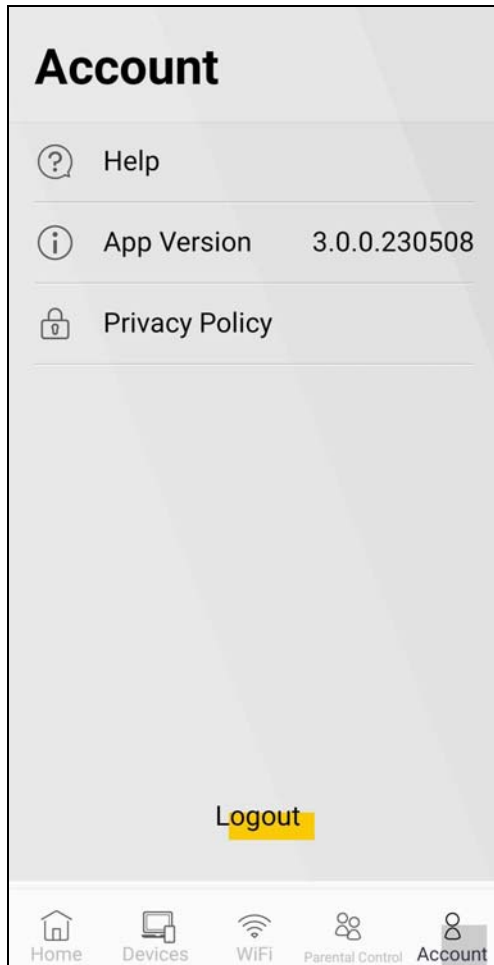
- 2 Swipe to the left to see the **Share Guest WiFi** QR code for connecting to the Zyxel Device Guest WiFi. Take a screenshot of the QR code and share it with the WiFi clients that you let access the Internet (only) through this WiFi network. These WiFi clients cannot access other devices on your network such as servers connected to the router.



## 6.13 Viewing More App Information and the Online Help

You can view the following information about the app:

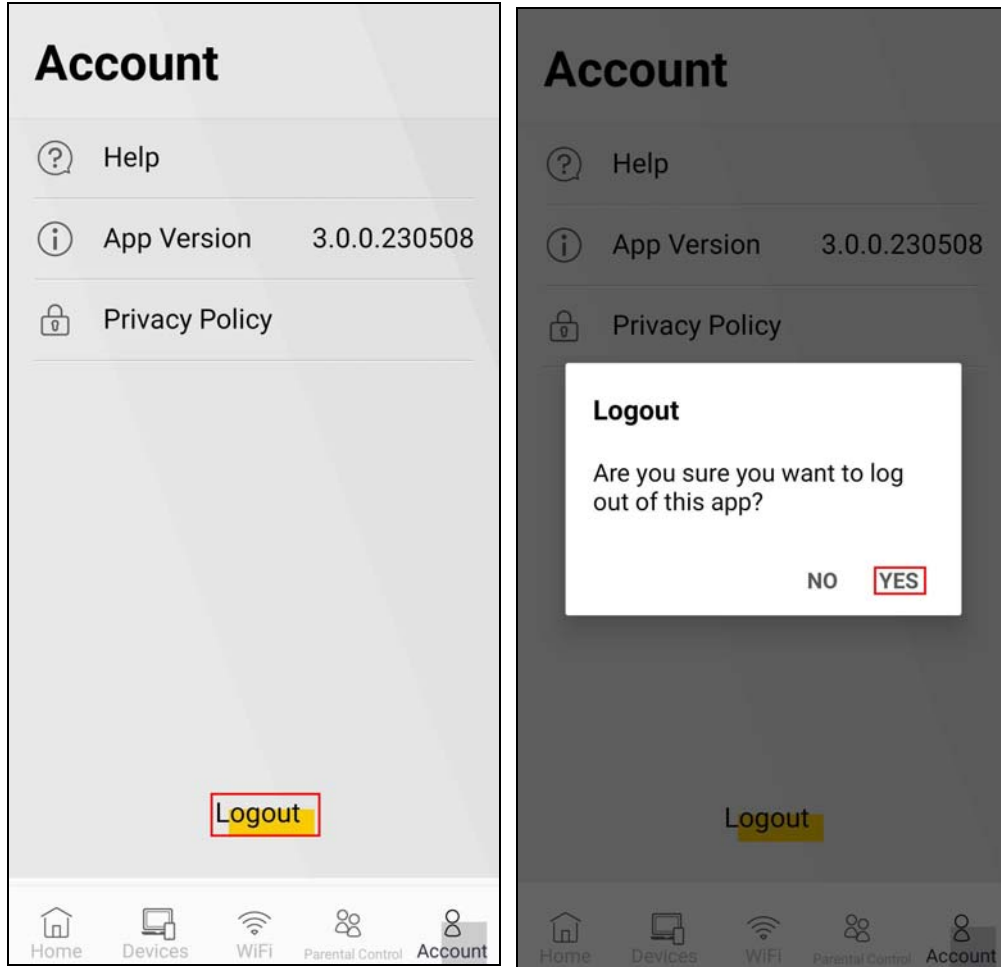
- The app online help page
- The app version
- The privacy policy.



### 6.13.1 Logging Out of the Controller Device

To log out of the current Controller device (the MPro Mesh router or extender) of this MPro Mesh network:

Tap the **Account** icon in the navigation panel. Tap **Logout**, then tap **YES**.





---

# PART II

## Technical Reference

---

# CHAPTER 7

## Connection Status

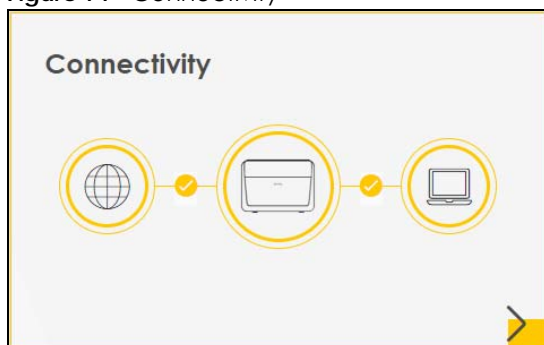
### 7.1 Connection Status Overview


After you log into the Web Configurator, the **Connection Status** screen appears. You can configure basic Internet access and WiFi settings in this screen. It also shows the network status of the Zyxel Device and computers or devices connected to it.

#### 7.1.1 Connectivity

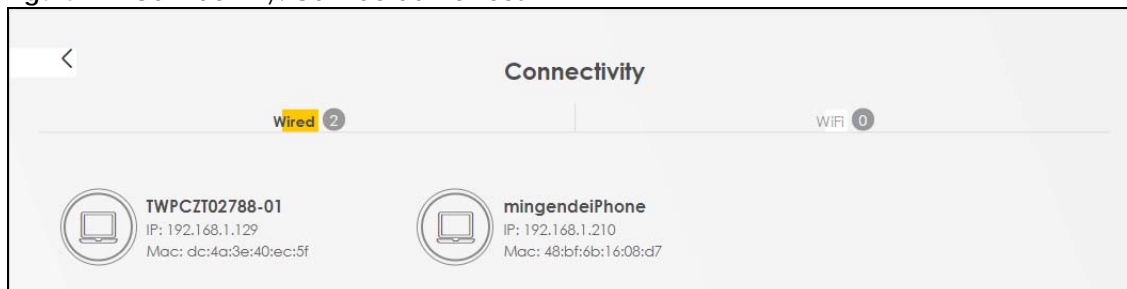
Use this screen to view the network connection status of the Zyxel Device and its clients.

**Figure 71** Connectivity



Click the Arrow icon (  ) to view IP addresses and MAC addresses of the wireless and wired devices connected to the Zyxel Device.

**Figure 72** Connectivity: Connected Devices

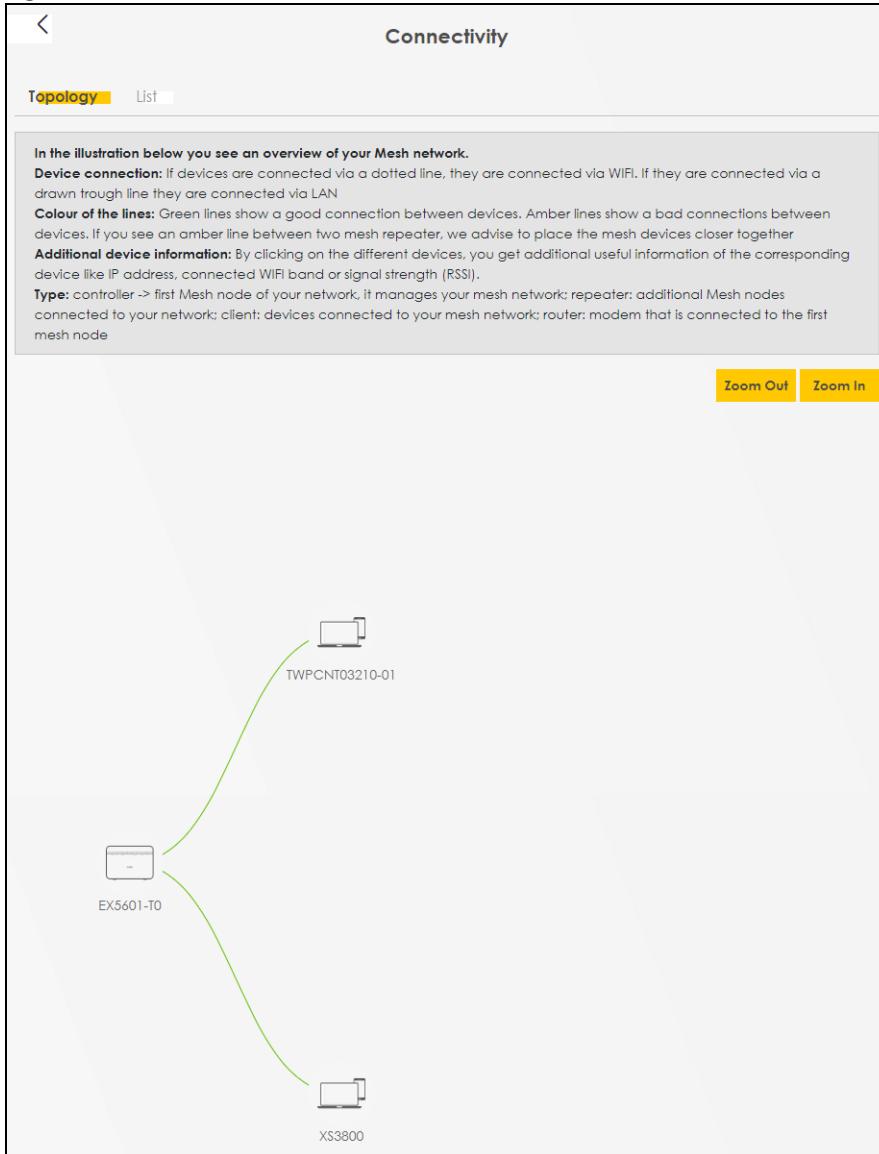


You can change the icon and name of a connected device. Place your mouse within the device block, and an Edit icon (  ) will appear. Click the Edit icon, and you'll see there are several icon choices for you to select. Enter a name in the **Device Name** field for a connected device. Click to enable (  ) **Internet Blocking** for a connected WiFi client.

The following screen appears when you enable **MPro Mesh** in the **Network Setting > Wireless > MESH** screen. Check [Section 1.1 on page 19](#) to see if your Zyxel Device supports MPro Mesh.

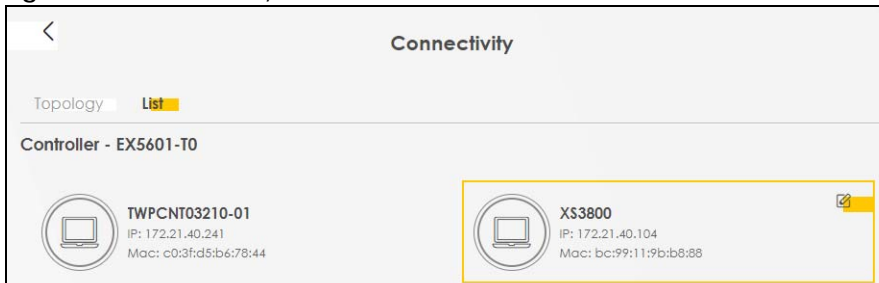
Use the **Topology** view screen to display an overview of your Mesh network.

**Figure 73** Connectivity: Connected Devices: Topology View



Use the **List** view screen to view IP addresses and MAC addresses of the WiFi and wired devices connected to the Zyxel Device. Place your mouse within the device block, and an **Edit** icon (✎) will appear. Click the **Edit** icon to change the icon and name of a connected device.

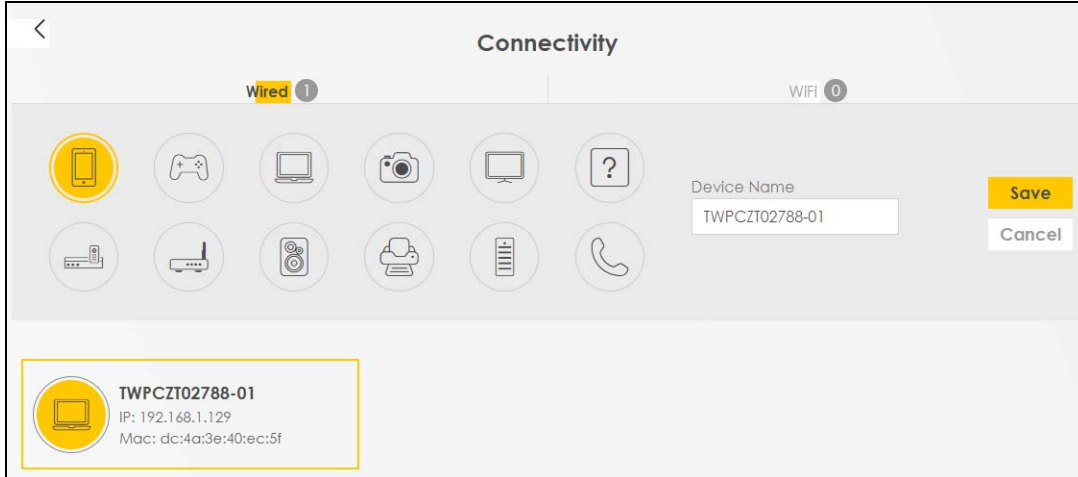
**Figure 74** Connectivity: Connected Devices: List View



## 7.1.2 Icon and Device Name

Select an icon and/or enter a name in the **Device Name** field for a connected device. Click to enable () **Internet Blocking** (or **Active**) for a connected WiFi client. Click **Save** to save your changes.

**Figure 75** Connectivity: Edit



## 7.1.3 System Info

Use this screen to view the basic system information of the Zyxel Device.

**Figure 76** System Info




Click the Arrow icon () to view more information on the status of your firewall and interfaces (WAN, LAN, and WLAN).

Figure 77 System Info: Detailed Information

**System Info**

Host Name: DX3301-T0  
 Model Name: DX3301-T0  
 Serial number: 8200F7410F9  
 Firmware Version: V5.50(ABVY.1)b3  
 System Uptime: 0 days 8 hours 13 minutes 11 seconds  
 Interface Up Time: 0 days 0 hours 8 minutes

**Interface Status**

LAN1: - LAN2: - LAN3: - LAN4: 1000M/Full WAN: 1000M/Full DSL: - 3G(USB): No Device WLAN (2.4G): 573 Mbps WLAN (5G): 1201 Mbps

**WAN Information (Ethernet WAN)**

Name: ETHWAN  
 Encapsulation: IPoE  
 IP Address: 172.21.40.26  
 Release  
 IP Subnet Mask: 255.255.252.0  
 IPv6 Address: N/A  
 MAC Address: 88AC:0874:1D:F9  
 Primary DNS server: 172.21.10.1  
 Secondary DNS server: 172.21.5.1

**LAN Information**

IP Address: 192.168.1.1  
 Subnet Mask: 255.255.255.0  
 IPv6 Address: N/A  
 IPv6 Link Local Address: fe80::8aac:c0ff:fe74:1dfe  
 DHCP: Server  
 MAC Address: 88AC:0874:1D:F9

**Security**

Firewall: Medium

**WLAN Information**

	2.4GHz	5GHz
MAC Address	88AC:0874:1D:F1	88AC:0874:1D:F2
Status	On	On
SSID	Zyxe1_1DF1	Zyxe1_1DF1
Channel	Auto(Current 5)	Auto(Current 108)
Security	WPA3-Personal-Transition	WPA3-Personal-Transition
802.11 Mode	802.11b/g/n/ax Mixed	802.11a/n/ac/ax Mixed
WPS	On	On

Each field is described in the following table.

Table 35 System Info: Detailed Information

LABEL	DESCRIPTION
Host Name	This field displays the ZyXel Device system name. It is used for identification.
Model Name	This shows the model number of your ZyXel Device.
Serial Number	This field displays the serial number of the ZyXel Device.
Firmware Version	This is the current version of the firmware inside the ZyXel Device.
System Uptime	This field displays how long the ZyXel Device has been running since it last started up. The ZyXel Device starts up when you plug it in, when you restart it ( <b>Maintenance &gt; Reboot</b> ), or when you reset it.

Table 35 System Info: Detailed Information (continued)

LABEL	DESCRIPTION
Interface Up Time/ WAN Interface Uptime	This field displays the length of time of the Ethernet WAN connection.
CPU Usage	This displays the current CPU usage percentage.
Memory Usage	This displays the current RAM usage percentage.
WAN Information (These fields display when you have a WAN connection.)	
Name	This field displays the name given to the Internet connection.
Encapsulation	This field displays the current encapsulation method.
IP Address	This field displays the current IP address of the Zyxel Device in the WAN. Click the <b>Release/Renew</b> button if you want to release/renew your WAN IP address.
IP Subnet Mask	This field displays the current subnet mask in the WAN.
IPv6 Address	This field displays the current IPv6 address of the Zyxel Device in the WAN.
MAC Address	This field displays the WAN Ethernet adapter MAC (Media Access Control) address of your Zyxel Device.
Primary DNS server	This field displays the first DNS server address assigned by the ISP.
Secondary DNS server	This field displays the second DNS server address assigned by the ISP.
Primary DNSv6 server	This field displays the first DNS server IPv6 address assigned by the ISP.
Secondary DNSv6 server	This field displays the second DNS server IPv6 address assigned by the ISP.
LAN Information	
IP Address	This is the current IP address of the Zyxel Device in the LAN.
Subnet Mask	This is the current subnet mask in the LAN.
IPv6 Address	This is the current IPv6 address of the Zyxel Device in the LAN.
IPv6 Link Local Address	This field displays the current link-local address of the Zyxel Device for the LAN interface.  A link-local address is a special type of the IP address that is only valid for communication within the local network segment or broadcast domain of the device. Typically, link-local addresses are used for automatic address configuration and neighbor discovery protocols.
DHCP	This field displays what DHCP services the Zyxel Device is providing to the LAN. The possible values are:  <b>Server</b> – The Zyxel Device is a DHCP server in the LAN. It assigns IP addresses to other computers in the LAN.  <b>Relay</b> – The Zyxel Device acts as a surrogate DHCP server and relays DHCP requests and responses between the remote server and the clients.  <b>Disable</b> – The Zyxel Device is not providing any DHCP services to the LAN.
MAC Address	This shows the network adapter MAC (Media Access Control) Address of the LAN interface.
Security	
Firewall	This displays the firewall's current security level ( <b>High, Medium, Low, or Disabled</b> ).
WLAN Information	
MAC Address	This shows the WiFi adapter MAC (Media Access Control) Address of the WiFi interface.
Status	This displays whether the WLAN is activated.
SSID	This is the descriptive name used to identify the Zyxel Device in a WLAN.
Channel	This is the channel number currently used by the WiFi interface.

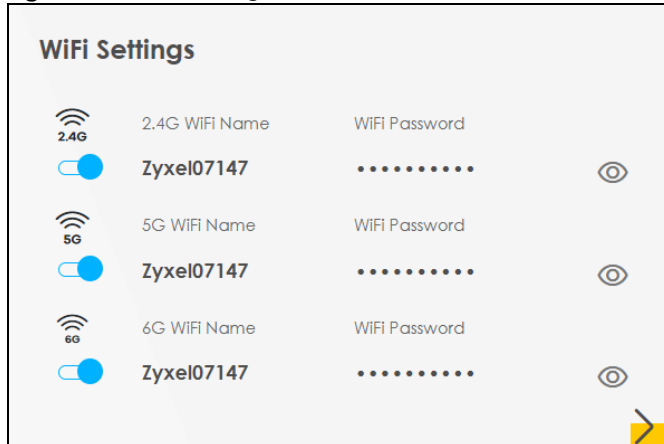
Table 35 System Info: Detailed Information (continued)

LABEL	DESCRIPTION
Security	This displays the type of security mode the WiFi interface is using in the WLAN.
802.11 Mode	This displays the type of 802.11 mode the WiFi interface is using in the WLAN.
WPS	This displays whether WPS is activated on the WiFi interface.

## 7.1.4 WiFi Settings

Use this screen to enable or disable the main WiFi network. When the switch turns blue, the function is enabled. You can use this screen or the QR code on the upper right corner to check the SSIDs (WiFi network name) and passwords of the main WiFi networks. If you want to show or hide your WiFi passwords, click the Eye icon (👁).

Figure 78 WiFi Settings



Click the Arrow icon (➤) to configure the SSIDs and/or passwords for your main WiFi networks. Click the Eye icon (👁) to display the characters as you enter the WiFi Password.



Scanning the QR code is an alternative way to connect your WiFi client to the WiFi network.

Note: When you enable MPro Mesh in the **Network > Wireless > MESH** screen, **Keep 2.4G, 5G and 6G the same** will be enabled and cannot be disabled.

Figure 79 WiFi Settings: Configuration

Each field is described in the following table.

Table 36 WiFi Settings: Configuration

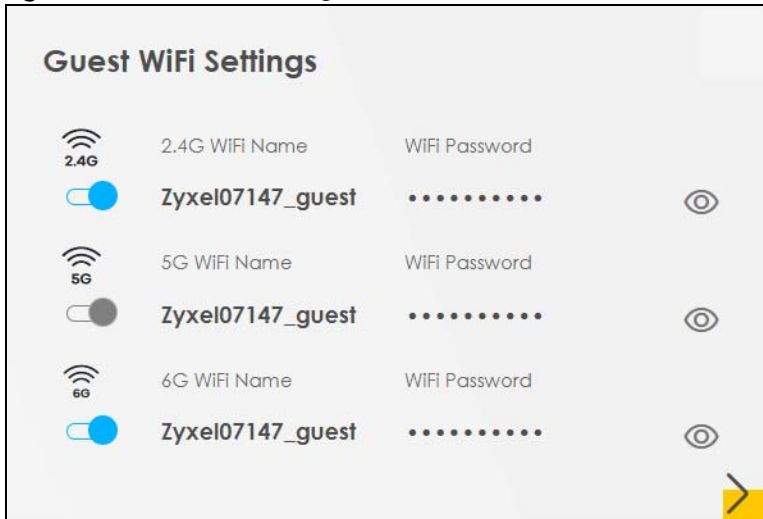
LABEL	DESCRIPTION
Keep 2.4G, 5G and 6G the same	Select this and the 2.4 GHz, 5 GHz and 6GHz wireless networks will use the same SSID. If you deselect this, the screen will change. You need to assign different SSIDs for the 2.4 GHz and 5 GHz wireless networks.
2.4G / 5G / 6G WiFi	Click this switch to enable or disable the 2.4G / 5G / 6G WiFi network. When the switch turns blue  , the function is enabled.
WiFi Name	The SSID (Service Set IDentity) identifies the service set with which a WiFi device is associated. WiFi devices associating to the access point (AP) must have the same SSID.  Enter a descriptive name for the WiFi. You can use up to 32 printable characters, including spaces.
WiFi Password	If you selected <b>Random Password</b> , this field displays a pre-shared key generated by the Zyxel Device.  If you did not select <b>Random Password</b> , you can manually enter a pre-shared key from 8 to 63 alphanumeric (0-9, a-z, A-Z) and special characters, including spaces.  Click the Eye icon to show or hide the password for your WiFi network. When the Eye icon is slashed  , you will see the password in plain text. Otherwise, it is hidden.
Random Password	Select this to have the Zyxel Device automatically generate a password. The <b>WiFi Password</b> field will not be configurable when you select this option.
Hide WiFi network name	Select this to hide the SSID in the outgoing beacon frame so a station cannot obtain the SSID through scanning using a site survey tool.  Note: Disable WPS in the <b>Network Setting &gt; Wireless &gt; WPS</b> screen to hide the SSID.
Save	Click <b>Save</b> to save your changes.




## 7.2 Guest WiFi Settings

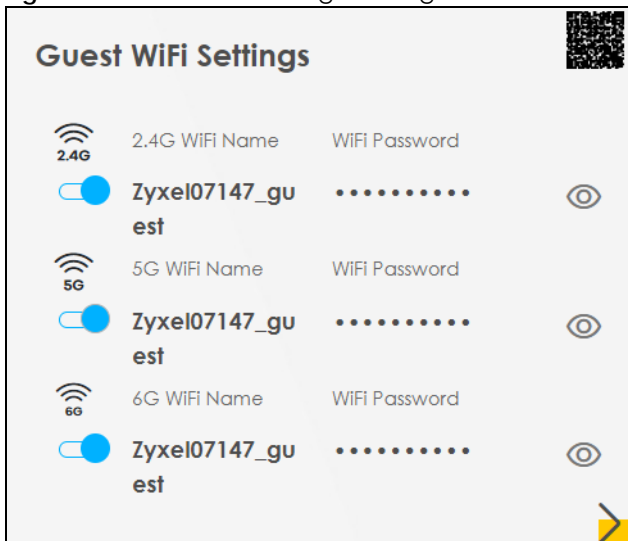
Use this screen to enable or disable the guest 2.4 GHz / 5 GHz /6GHz WiFi networks. When the switch goes to the right (  ), the function is enabled. Otherwise, it is not. You can check their SSIDs (WiFi network name) and passwords from this screen. If you want to show or hide your WiFi passwords, click the Eye icon.

**Figure 80** Guest WiFi Settings



Click the Arrow icon (  ) to open the following screen. Use this screen configure the SSIDs and/or passwords for your guest WiFi networks.

**Figure 81** Guest WiFi Settings: Configuration





To assign different SSIDs to the 2.4 GHz and 5 GHz guest wireless networks, clear the **Keep 2.4G, 5G and 6G the same** check box in the **WiFi Settings** screen, and the **Guest WiFi Settings** screen will change.

Figure 82 Guest WiFi Settings: Different SSIDs

Each field is described in the following table.

Table 37 WiFi Settings: Configuration

LABEL	DESCRIPTION
2.4G/5G/6G WiFi	Click this switch to enable or disable the 2.4 GHz / 5 GHz / 6GHz WiFi networks. When the switch goes to the right  , the function is enabled. Otherwise, it is not.
WiFi Name	The SSID (Service Set IDentity) identifies the service set with which a wireless device is associated. Wireless devices associating to the access point (AP) must have the same SSID. Enter a descriptive name (up to 32 printable characters, including spaces) for the WiFi.
WiFi Password	If you selected <b>Random Password</b> , this field displays a pre-shared key generated by the Zyxel Device. If you did not select <b>Random Password</b> , you can manually enter a pre-shared key from 8 to 64 alphanumeric (0-9, a-z, A-Z) and special characters, including spaces.
Strength	This displays the current password strength – <b>weak</b> , <b>medium</b> , <b>strong</b> .
	Click the Eye icon to show or hide the password of your WiFi network. When the Eye icon is slashed  , you will see the password in plain text. Otherwise, it is hidden.
Random Password	Select this option to have the Zyxel Device automatically generate a password. The <b>WiFi Password</b> field will not be configurable when you select this option.
Hide WiFi network name	Select this check box to hide the SSID in the outgoing beacon frame so a station cannot obtain the SSID through scanning using a site survey tool.  Note: Disable WPS in the <b>Network Setting &gt; Wireless &gt; WPS</b> screen to hide the SSID.
Save	Click <b>Save</b> to save your changes.

## 7.2.1 LAN

Use this screen to view the LAN IP address, subnet mask, and DHCP settings of your Zyxel Device. Click the switch button to turn on/off the DHCP server.

Figure 83 LAN

**LAN**

IP Address **192.168.1.1**

Subnet Mask **255.255.255.0**

IP Address Range **192.168.1.3 ~ 192.168.1.254**

DHCP

Lease Time **1 days 0 hours 0 mins**


Click the Arrow icon (  ) to configure the LAN IP settings and DHCP setting for your Zyxel Device.

Figure 84 LAN Setup

**LAN**

**LAN IP Setup**

IP Address

Subnet Mask

**IP Addressing Values**

Beginning IP Address

Ending IP Address

**DHCP Server State**

DHCP Server Lease Time  days  hours  minutes

**Save**

Each field is described in the following table.

Table 38 LAN Setup

LABEL	DESCRIPTION
LAN IP Setup	
IP Address	Enter the LAN IPv4 IP address you want to assign to your Zyxel Device in dotted decimal notation, for example, 192.168.1.1 (factory default).
Subnet Mask	Enter the subnet mask of your network in dotted decimal notation, for example 255.255.255.0 (factory default). Your Zyxel Device automatically computes the subnet mask based on the IP Address you enter, so do not change this field unless you are instructed to do so.
IP Addressing Values	
Beginning IP Address	This field specifies the first of the contiguous addresses in the IP address pool.
Ending IP Address	This field specifies the last of the contiguous addresses in the IP address pool.

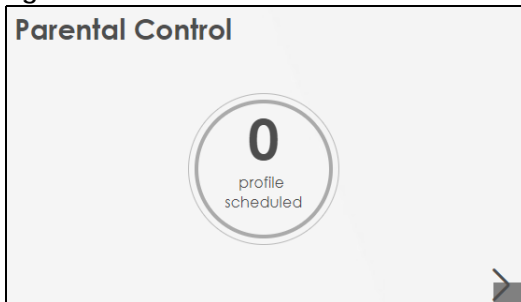
Table 38 LAN Setup (continued)

LABEL	DESCRIPTION
DHCP Server State	
DHCP Server Lease Time	This is the period of time a DHCP-assigned address is valid, before it expires.  When a client connects to the Zyxel Device, DHCP automatically assigns the client an IP addresses from the IP address pool. DHCP leases each addresses for a limited period of time, which means that past addresses are "recycled" and made available for future reassignment to other devices.
Days/Hours/Minutes	Enter the lease time of the DHCP server.

## 7.3 The Parental Control Screen

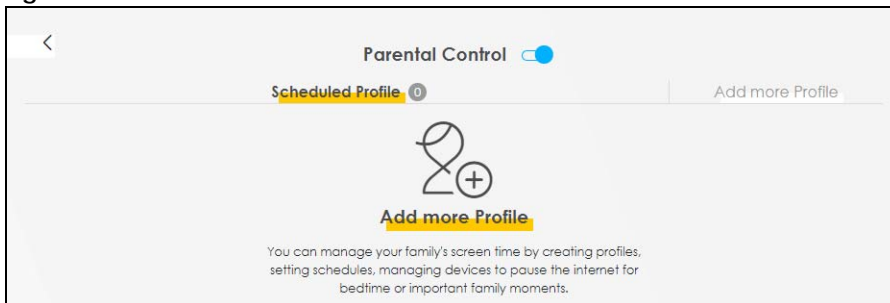
Use this screen to view the number of profiles that were created for parental control.

Figure 85 Parental Control



Click the yellow Arrow icon to open the following screen. Use this screen to enable parental control and add more profiles. Add a profile to create restricted access schedules. Go to the **Security > Parental Control > Add New PCP/Edit** screen to configure URL filtering settings to block the users on your network from accessing certain web sites.

Figure 86 Parental Control



Each field is described in the following table.

Table 39 Parental Control: Schedule

LABEL	DESCRIPTION
Parental Control	Click this switch to enable parental control.
Scheduled Profile	This screen shows all the created profiles.
Add More Profile	Click this to create a new profile.


## 7.3.1 Create a Parental Control Profile

Click **Add more Profile** to create a profile. Use this screen to add a devices in a profile and block Internet access on the profile devices.

**Figure 87** Parental Control: Add More Profile

Each field is described in the following table.

**Table 40** Parental Control: Add More Profile

LABEL	DESCRIPTION
Profile Name	Enter a descriptive name for the profile.
Profile Active	Click this switch to enable or disable Internet access. When the switch goes to the right  , the function is enabled. Otherwise, it is not.
Profile Device List	This field shows the devices selected on the right for this profile.
Blocking Schedule	This field shows the time during which Internet access is blocked on the profile device(s).
	Select a device(s) on your network for this profile.

**Figure 88** Parental Control: Schedule

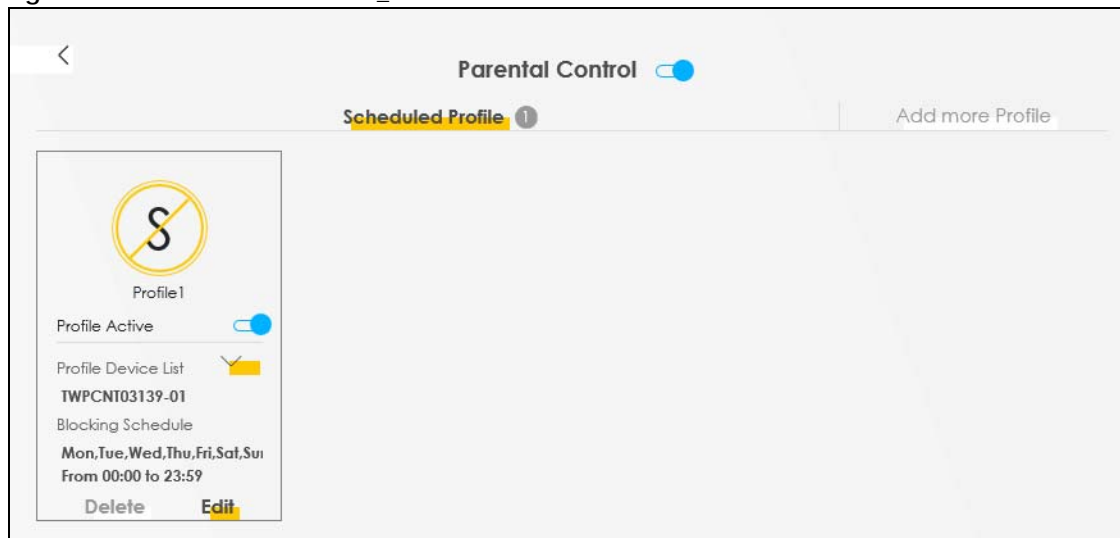
Each field is described in the following table.

Table 41 Parental Control: Schedule

LABEL	DESCRIPTION
Profile Name	Enter a descriptive name for the profile. You can use up to 17 printable characters except [ " ], [ ` ], [ ' ], [ < ], [ > ], [ ^ ], [ \$ ], [   ], [ & ], or [ ; ]. Spaces are allowed.
Profile Active	Click this switch to enable this profile.
Profile Device List	This field shows the devices selected on the right for this profile.
Blocking Schedule	This field shows the time during which Internet access is blocked on the profile devices.
Schedule	
Add New Schedule	Click this to add a new block for scheduling.
Start/End blocking	Select the time period when Internet access is blocked on the profile devices.
Repeat On	Select the days when Internet access is blocked on the profile devices. Select <b>Whole Week</b> to make the profile schedule repeat on everyday.
Back	Click <b>Back</b> to return to the previous screen.
Save	Click <b>Save</b> to save your changes.

Once a profile is created, it will show in the following screen. Click this  to **Delete** or **Edit** a profile.

Figure 89 Parental Control: Edit\_Delete



# CHAPTER 8

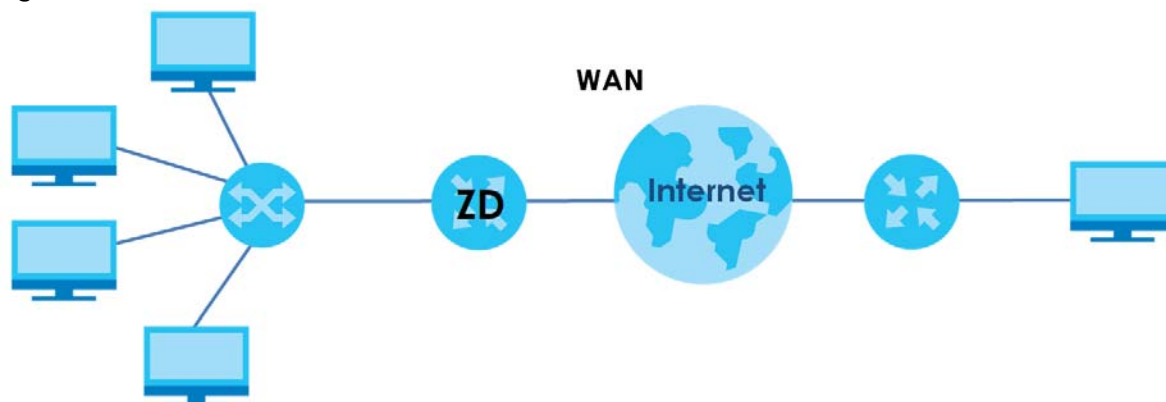
## Broadband

### 8.1 Broadband Overview

This chapter discusses the Zyxel Device's **Broadband** screens. Use these screens to configure your Zyxel Device for Internet access.

A Wide Area Network (WAN) connection is an outside connection to another network or the Internet. It connects your private networks, such as a Local Area Network (LAN) and other networks, so that a computer in one location can communicate with computers in other locations.

**Figure 90** LAN and WAN



#### 8.1.1 What You Can Do in this Chapter

- Use **Broadband** screens to view, remove or add a WAN interface. You can also configure the WAN settings on the Zyxel Device for Internet access.

The **Broadband** screens for DSL routers and Ethernet/AON/PON routers are slightly different.

For DSL routers, see [Section 8.2 on page 203](#).

For Ethernet, AON and PON routers, see [Section 8.3 on page 212](#).

See [Section 1.1 on page 19](#) to see which router type your Zyxel Device belongs to.

- Use the **Cellular Backup** screen to configure cellular WAN connection ([Section 8.4 on page 221](#)).
- Use the **Advanced** screen to enable or disable PTM over ADSL, Annex M/Annex J, and DSL PhyR functions ([Section 8.5 on page 227](#)).
- Use the **Backup WAN** screen to convert the fourth LAN port as a WAN port or reset the Ethernet WAN port to a LAN port ([Section 8.6 on page 231](#)).

Table 42 WAN Setup Overview

LAYER-2 INTERFACE	INTERNET CONNECTION		
CONNECTION	MODE	ENCAPSULATION	CONNECTION SETTINGS
Ethernet	Routing	PPPoE	PPP user name and password, WAN IPv4/IPv6 IP address, routing feature, DNS server, VLAN, QoS, and MTU
		IPoE	WAN IPv4/IPv6 IP address, NAT, DNS server and routing feature
	Bridge	N/A	VLAN
Note: This table is for the Ethernet, AON and PON routers. See <a href="#">Section 1.1 on page 19</a> for more information.			

Table 43 WAN Setup Overview

LAYER-2 INTERFACE		INTERNET CONNECTION		
CONNECTION	DSL LINK TYPE	MODE	ENCAPSULATION	CONNECTION SETTINGS
ADSL/VDSL over PTM	N/A	Routing	PPPoE	PPP information, IPv4/IPv6 IP address, routing feature, DNS server, VLAN, QoS, and MTU
			IPoE	IPv4/IPv6 IP address, routing feature, DNS server, VLAN, QoS, and MTU
		Bridge	N/A	VLAN and QoS
ADSL over ATM	EoA	Routing	PPPoE/PPPoA	ATM PVC configuration, PPP information, IPv4/IPv6 IP address, routing feature, DNS server, VLAN, QoS, and MTU
			IPoE/IPoA	ATM PVC configuration, IPv4/IPv6 IP address, routing feature, DNS server, VLAN, QoS, and MTU
		Bridge	N/A	ATM PVC configuration, and QoS
Ethernet	N/A	Routing	PPPoE	PPP user name and password, WAN IPv4/IPv6 IP address, routing feature, DNS server, VLAN, QoS, and MTU
			IPoE	WAN IPv4/IPv6 IP address, NAT, DNS server and routing feature
		Bridge	N/A	VLAN and QoS
Note: This table is for the DSL routers. See <a href="#">Section 1.1 on page 19</a> for more information.				

## 8.1.2 What You Need to Know

The following terms and concepts may help as you read this chapter.

### WAN IP Address

The WAN IP address is an IP address for the Zyxel Device, which makes it accessible from an outside network. It is used by the Zyxel Device to communicate with other devices in other networks. It can be static (fixed) or dynamically assigned by the ISP each time the Zyxel Device tries to access the Internet.



If your ISP assigns you a static WAN IP address, they should also assign you the subnet mask and DNS server IP addresses.

## ATM

Asynchronous Transfer Mode (ATM) is a WAN networking technology that provides high-speed data transfer. ATM uses fixed-size packets of information called cells. With ATM, a high QoS (Quality of Service) can be guaranteed. ATM uses a connection-oriented model and establishes a virtual circuit (VC).

## PTM

Packet Transfer Mode (PTM) is packet-oriented and supported by the VDSL2 standard. In PTM, packets are encapsulated directly in the High-level Data Link Control (HDLC) frames. It is designed to provide a low-overhead, transparent way of transporting packets over DSL links, as an alternative to ATM.

## IPv6 Introduction

IPv6 (Internet Protocol version 6), is designed to enhance IP address size and features. The increase in IPv6 address size to 128 bits (from the 32-bit IPv4 address) allows up to  $3.4 \times 10^{38}$  IP addresses. The Zyxel Device can use IPv4/IPv6 dual stack to connect to IPv4 and IPv6 networks, and supports IPv6 rapid deployment (6RD).

## IPv6 Addressing

The 128-bit IPv6 address is written as eight 16-bit hexadecimal blocks separated by colons (:). This is an example IPv6 address `2001:0db8:1a2b:0015:0000:0000:1a2f:0000`.

IPv6 addresses can be abbreviated in two ways:

- Leading zeros in a block can be omitted. So `2001:0db8:1a2b:0015:0000:0000:1a2f:0000` can be written as `2001:db8:1a2b:15:0:0:1a2f:0`.
- Any number of consecutive blocks of zeros can be replaced by a double colon. A double colon can only appear once in an IPv6 address. So `2001:0db8:0000:0000:1a2f:0000:0000:0015` can be written as `2001:0db8::1a2f:0000:0000:0015`, `2001:0db8:0000:0000:1a2f::0015`, `2001:db8::1a2f:0:0:15` Or `2001:db8:0:0:1a2f::15`.

## IPv6 Prefix and Prefix Length

Similar to an IPv4 subnet mask, IPv6 uses an address prefix to represent the network address. An IPv6 prefix length specifies how many most significant bits (start from the left) in the address compose the network address. The prefix length is written as "/x" where x is a number. For example,

```
2001:db8:1a2b:15::1a2f:0/32
```

means that the first 32 bits (`2001:db8`) is the subnet prefix.

## IPv6 Subnet Masking

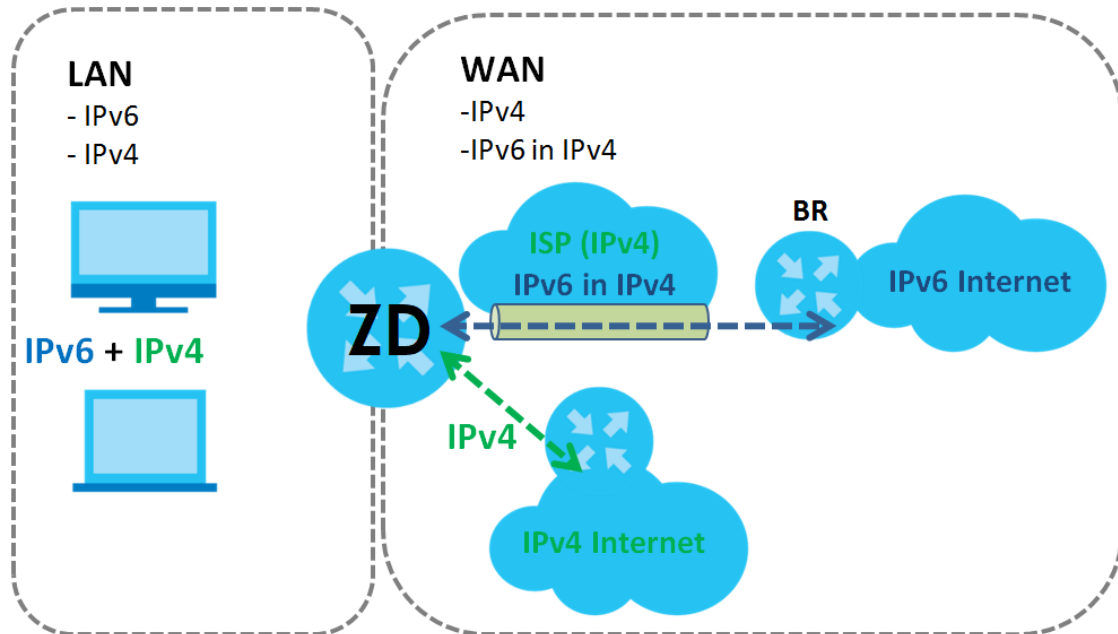
Both an IPv6 address and IPv6 subnet mask compose of 128-bit binary digits, which are divided into eight 16-bit blocks and written in hexadecimal notation. Hexadecimal uses four bits for each character (1 – 10, A – F). Each block's 16 bits are then represented by four hexadecimal characters. For example, `FFFF:FFFF:FFFF:FFFF:FC00:0000:0000:0000`.

## IPv6 Rapid Deployment

Use IPv6 Rapid Deployment (6rd) when the local network uses IPv6 and the ISP has an IPv4 network. When the Zyxel Device has an IPv4 WAN address and you set **IPv6/IPv4 Mode** to **IPv4 Only**, you can enable 6rd to encapsulate IPv6 packets in IPv4 packets to cross the ISP's IPv4 network.

The Zyxel Device generates a global IPv6 prefix from its IPv4 WAN address and tunnels IPv6 traffic to the ISP's Border Relay router (BR in the figure) to connect to the native IPv6 Internet. The local network can also use IPv4 services. The Zyxel Device uses its configured IPv4 WAN IP to route IPv4 traffic to the IPv4 Internet.

Figure 91 IPv6 Rapid Deployment

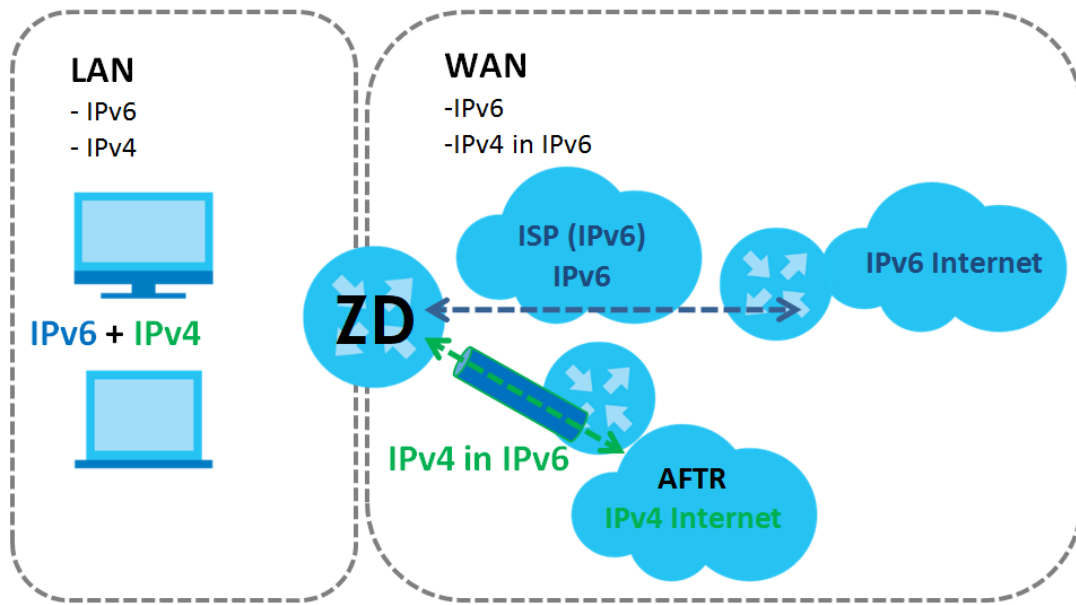


## Dual Stack Lite

Use Dual Stack Lite when local network computers use IPv4 and the ISP has an IPv6 network. When the Zyxel Device has an IPv6 WAN address and you set **IPv6/IPv4 Mode** to **IPv6 Only**, you can enable Dual Stack Lite to use IPv4 computers and services.

The Zyxel Device tunnels IPv4 packets inside IPv6 encapsulation packets to the ISP's Address Family Transition Router (AFTR in the graphic) to connect to the IPv4 Internet. The local network can also use IPv6 services. The Zyxel Device uses its configured IPv6 WAN IP to route IPv6 traffic to the IPv6 Internet.

Figure 92 Dual Stack Lite



### 8.1.3 Before You Begin

You need to know your Internet access settings such as encapsulation and WAN IP address. Get this information from your ISP.

## 8.2 Broadband Settings for DSL Routers

Use this screen to change your Zyxel Device's Internet access settings. The summary table shows you the configured WAN services (connections) on the Zyxel Device. Use information provided by your ISP to configure WAN settings.

Click **Network Setting > Broadband** to access this screen.

Figure 93 Network Setting > Broadband

Broadband												
<span style="background-color: #FFD700;">Broadband</span> Cellular Backup Advanced												
Use this screen to change your Zyxel Device's Internet access settings. The summary table shows you the configured WAN services (connections) on the Zyxel Device. Use information provided by your ISP to configure WAN settings.												
												<span style="color: #FFD700;">+</span> Add New WAN Interface
#	Name	Type	Mode	Encapsulation	802.1p	802.1q	IGMP Proxy	NAT	Default Gateway	IPv6	MLD Proxy	Modify
1	ADSL	ATM	Routing	IPoE	N/A	N/A	Y	Y	Y	Y	Y	
2	VDSL	PTM	Routing	IPoE	N/A	N/A	Y	Y	Y	Y	Y	
3	ETHWAN	ETH	Routing	IPoE	N/A	N/A	Y	Y	Y	Y	Y	
4	SFPWAN	SFP	Routing	IPoE	N/A	N/A	Y	Y	Y	Y	Y	

The following table describes the labels in this screen.

Table 44 Network Setting > Broadband

LABEL	DESCRIPTION
Add New WAN Interface	Click this button to create a new connection.
#	This is the index number of the entry.
Name	This is the service name of the connection.
Type	This shows types of connections the router has.
Mode	This shows whether the connection is in routing or bridge mode.
Encapsulation	This is the method of encapsulation used by this connection.
802.1p	This indicates the 802.1p priority level assigned to traffic sent through this connection. This displays <b>N/A</b> when there is no priority level assigned.
802.1q	This indicates the VLAN ID number assigned to traffic sent through this connection. This displays <b>N/A</b> when there is no VLAN ID number assigned.
IGMP Proxy	This shows whether the Zyxel Device act as an IGMP proxy on this connection.
NAT	This shows whether NAT is activated or not for this connection.
Default Gateway	This shows whether the Zyxel Device use the WAN interface of this connection as the system default gateway.
IPv6	This shows whether IPv6 is activated or not for this connection. IPv6 is not available when the connection uses the bridging service.
MLD Proxy	This shows whether Multicast Listener Discovery (MLD) is activated or not for this connection. MLD is not available when the connection uses the bridging service.
Modify	Click the <b>Edit</b> icon to configure the WAN connection.  Click the <b>Delete</b> icon to remove the WAN connection.

## 8.2.1 Add or Edit Internet Connection

Click **Add New WAN Interface** in the **Broadband** screen or the Edit icon next to an existing WAN interface to open the following screen. Use this screen to configure a WAN connection. The screen varies depending on the mode, encapsulation, and IPv6 or IPv4 mode you select.

### Routing Mode

Use **Routing** mode if your ISP give you one IP address only and you want multiple computers to share an Internet account.

The following example screen displays when you select the **Routing** mode and **PPPoE** encapsulation. The screen varies when you select other encapsulation and IPv6 or IPv4 mode.

Figure 94 Network Setting > Broadband > Add or Edit New WAN Interface (Routing Mode)

←
Edit WAN Interface

<div style="text-align: right; margin-bottom: 10px;"> <b>General</b> <input checked="" type="checkbox"/> </div> <p>Name: <input type="text" value="ADSL"/></p> <p>Type: <input type="text" value="ADSL over ATM"/></p> <p>Mode: <input type="text" value="Routing"/></p> <p>Encapsulation: <input type="text" value="PPPoE"/></p> <p>IPv4/IPv6 Mode: <input type="text" value="IPv4 IPv6 DualStack"/></p>	<div style="text-align: right; margin-bottom: 10px;"> <b>PPP Information</b> </div> <p>PPP User Name: <input type="text" value="admin"/></p> <p>PPP Password: <input type="password" value="****"/> <span style="font-size: 18px;">👁</span></p> <p>PPP Connection Trigger: <input checked="" type="radio"/> Auto Connect <input type="radio"/> On Demand</p> <p>PPPoE Passthrough: <input type="checkbox"/></p>
<div style="text-align: right; margin-bottom: 10px;"> <b>ATM PVC Configuration</b> </div> <p>VPI [0-255]: <input type="text" value="0"/></p> <p>VCI [32-65535]: <input type="text" value="33"/></p> <p>Encapsulation: <input type="text" value="LLC/SNAP-BRIDGIN"/></p> <p>Service Category: <input type="text" value="UBR Without PCR"/></p>	<div style="text-align: right; margin-bottom: 10px;"> <b>VLAN</b> <input type="checkbox"/> </div> <p>802.1p: <input type="text" value="0"/></p> <p>802.1q: <input type="text" value=""/> (0-4094)</p> <div style="text-align: right; margin-top: 10px;"> <b>MTU</b> </div> <p>MTU: <input type="text" value="1500"/></p>
<div style="text-align: center; margin-bottom: 10px;"> <b>IP Address</b> </div> <p><input checked="" type="radio"/> Obtain an IP Address Automatically</p> <p><input type="radio"/> Static IP Address</p> <div style="text-align: center; margin-top: 10px;"> <b>DNS Server</b> </div> <p><input checked="" type="radio"/> Obtain DNS Info Automatically</p> <p><input type="radio"/> Use Following Static DNS Address</p>	<div style="text-align: center; margin-bottom: 10px;"> <b>Routing Feature</b> </div> <p>NAT: <input checked="" type="checkbox"/> <span style="margin-left: 100px;">IGMP Proxy: <input checked="" type="checkbox"/></span></p> <p>Apply as Default Gateway: <input checked="" type="checkbox"/> <span style="margin-left: 100px;">Fullcone NAT: <input type="checkbox"/></span></p>
<div style="text-align: center; margin-bottom: 10px;"> <b>IPv6 Address</b> </div> <p><input checked="" type="radio"/> Obtain an IPv6 Address Automatically</p> <p><input type="radio"/> Static IPv6 Address</p> <div style="text-align: center; margin-top: 10px;"> <b>IPv6 DNS Server</b> </div> <p><input checked="" type="radio"/> Obtain IPv6 DNS Info Automatically</p> <p><input type="radio"/> Use Following Static IPv6 DNS Address</p>	<div style="text-align: center; margin-bottom: 10px;"> <b>IPv6 Routing Feature</b> </div> <p>MLD Proxy: <input checked="" type="checkbox"/> <span style="margin-left: 100px;">Apply as Default Gateway: <input checked="" type="checkbox"/></span></p> <div style="text-align: center; margin-top: 10px;"> <b>DHCPv6 Option</b> </div> <p>IPv6 Address From DHCPv6 Server: <input type="checkbox"/> <span style="margin-left: 100px;">Other Information From DHCPv6 Server: <input type="checkbox"/></span></p>

Cancel
Apply

The following table describes the labels in this screen.

Table 45 Network Setting > Broadband > Add or Edit New WAN Interface (Routing Mode)

LABEL	DESCRIPTION
General	
Click the switch to enable this WAN interface.	
Name	Specify a descriptive name for this connection. You can use up to 15 alphanumeric (0-9, a-z, A-Z) and special characters except [ " ], [ ` ], [ ' ], [ < ], [ > ], [ ^ ], [ \$ ], [   ], [ & ], or [ ; ]. Spaces are allowed.  This field is read-only if you are editing the WAN interface.
Type	This field shows the types of available connections.  This field is read-only if you are editing the WAN interface.
Mode	Select <b>Routing</b> if your ISP give you one IP address only and you want multiple computers to share an Internet account.
Encapsulation	Select the method of encapsulation used by your ISP from the drop-down list box. This option is available only when you select <b>Routing</b> in the <b>Mode</b> field.  When you select <b>ADSL/VDSL over ATM</b> or <b>Ethernet</b> , the choices are <b>PPPoE</b> and <b>IPoE</b> .  When you select <b>ADSL over ATM</b> , the choices are <b>PPPoE</b> , <b>IPoE</b> , <b>PPPoA</b> and <b>IPoA</b> .
IPv4/IPv6 Mode	Select <b>IPv4 Only</b> if you want the Zyxel Device to run IPv4 only.  Select <b>IPv4 IPv6 DualStack</b> to allow the Zyxel Device to run IPv4 and IPv6 at the same time.  Select <b>IPv6 Only</b> if you want the Zyxel Device to run IPv6 only.
PPP Information (This is available only when you select <b>Routing</b> in the <b>Mode</b> field and <b>PPPoE</b> or <b>PPPoA</b> in the <b>Encapsulation</b> field.)	
PPP User Name	Enter the user name exactly as your ISP assigned. If assigned a name in the form user@domain where domain identifies a service name, then enter both components exactly as given.
PPP Password	Enter the password associated with the user name above. Select <b>password unmask</b> to show your entered password in plain text.
PPP Connection Trigger	Select when to have the Zyxel Device establish the PPP connection.  <b>Auto Connect</b> – select this to not let the connection time out.  <b>On Demand</b> – select this to automatically bring up the connection when the Zyxel Device receives packets destined for the Internet.
Idle Timeout	This value specifies the time in minutes that elapses before the router automatically disconnects from the PPPoE server.  This field is not available if you select <b>Auto Connect</b> in the <b>PPP Connection Trigger</b> field.
PPPoE Passthrough	This field is available when you select <b>PPPoE</b> encapsulation.  In addition to the Zyxel Device's built-in PPPoE client, you can enable PPPoE pass through to allow up to ten hosts on the LAN to use PPPoE client software on their computers to connect to the ISP through the Zyxel Device. Each host can have a separate account and a public WAN IP address.  PPPoE pass through is an alternative to NAT for application where NAT is not appropriate.  Disable PPPoE pass through if you do not need to allow hosts on the LAN to use PPPoE client software on their computers to connect to the ISP.
ATM PVC Configuration (This is available only when you select <b>ADSL over ATM</b> in the <b>Type</b> field.)	
VPI [0-255]	The valid range for the VPI is 0 to 255. Enter the VPI assigned to you.
VCI [32-65535]	The valid range for the VCI is 32 to 65535 (0 to 31 is reserved for local management of ATM traffic). Enter the VCI assigned to you.

Table 45 Network Setting &gt; Broadband &gt; Add or Edit New WAN Interface (Routing Mode) (continued)

LABEL	DESCRIPTION
Encapsulation	Select the method of multiplexing used by your ISP from the drop-down list box. Choices are: <ul style="list-style-type: none"> <li>• <b>LLC/SNAP-BRIDGING:</b> In LLC encapsulation, bridged PDUs are encapsulated by identifying the type of the bridged media in the SNAP header.</li> <li>• <b>VC/MUX:</b> In VC multiplexing, each protocol is carried on a single ATM virtual circuit (VC). To transport multiple protocols, the Zyxel Device needs separate VCs. There is a binding between a VC and the type of the network protocol carried on the VC. This reduces payload overhead since there is no need to carry protocol information in each Protocol Data Unit (PDU) payload.</li> </ul>
Service Category	Select <b>UBR Without PCR</b> for applications that are non-time sensitive, such as email. Select <b>CBR</b> (Continuous Bit Rate) to specify fixed (always-on) bandwidth for voice or data traffic. Select <b>Non Realtime VBR</b> (non real-time Variable Bit Rate) for connections that do not require closely controlled delay and delay variation. Select <b>Realtime VBR</b> (real-time Variable Bit Rate) for applications with bursty connections that require closely controlled delay and delay variation.
Peak Cell Rate [cells/s]	Divide the DSL line rate (bps) by 424 (the size of an ATM cell) to find the Peak Cell Rate (PCR). This is the maximum rate at which the sender can send cells. Type the PCR here.
Sustainable Cell Rate	The Sustain Cell Rate (SCR) sets the average cell rate (long-term) that can be transmitted. Type the SCR, which must be less than the PCR. Note that system default is 0 cells/sec.
Maximum Burst Size [cells]	Maximum Burst Size (MBS) refers to the maximum number of cells that can be sent at the peak rate. Type the MBS, which is less than 65535.
VLAN Click this switch to enable VLAN on this WAN interface. This field is not available if you select <b>ADSL over ATM</b> in the <b>Type</b> field and <b>PPPoA</b> or <b>IPoA</b> in the <b>Encapsulation</b> field.	
802.1p	IEEE 802.1p defines up to 8 separate traffic types by inserting a tag into a MAC-layer frame that contains bits to define class of service. Select the IEEE 802.1p priority level (from 0 to 7) to add to traffic through this connection. The greater the number, the higher the priority level.
802.1q	Type the VLAN ID number (from 0 to 4094) for traffic through this connection.
MTU (This is not available if you select <b>ADSL over ATM</b> in the <b>Type</b> field and <b>PPPoA</b> or <b>IPoA</b> in the <b>Encapsulation</b> field.)	
MTU	Enter the MTU (Maximum Transfer Unit) size for traffic through this connection.
IP Address (This is available only when you select <b>IPv4 Only</b> or <b>IPv4 IPv6 DualStack</b> in the <b>IPv4/IPv6 Mode</b> field.)	
Obtain an IP Address Automatically	A static IP address is a fixed IP that your ISP gives you. A dynamic IP address is not fixed; the ISP assigns you a different one each time you connect to the Internet. Select this if you have a dynamic IP address.
Static IP Address	Select this option if the ISP assigned a fixed IP address.
IP Address	Enter the static IP address provided by your ISP.
Subnet Mask	Enter the subnet mask provided by your ISP. This is available only when you set the <b>Encapsulation</b> to <b>IPoE</b> or <b>IPoA</b> .
Gateway IP Address	Enter the gateway IP address provided by your ISP. This is available only when you set the <b>Encapsulation</b> to <b>IPoE</b> .
DNS Server (This is available only when you select <b>IPv4 Only</b> or <b>IPv4 IPv6 DualStack</b> in the <b>IPv4/IPv6 Mode</b> field.)	
Obtain DNS Info Automatically	Select <b>Obtain DNS Info Automatically</b> if you want the Zyxel Device to use the DNS server addresses assigned by your ISP.
Use Following Static DNS Address	Select <b>Use Following Static DNS Address</b> if you want the Zyxel Device to use the DNS server addresses you configure manually.

Table 45 Network Setting &gt; Broadband &gt; Add or Edit New WAN Interface (Routing Mode) (continued)

LABEL	DESCRIPTION
Primary DNS Server	Enter the first DNS server address assigned by the ISP.
Secondary DNS Server	Enter the second DNS server address assigned by the ISP.
Routing Feature (This is available only when you select <b>IPv4 Only</b> or <b>IPv4 IPv6 DualStack</b> in the <b>IPv4/IPv6 Mode</b> field.)	
NAT	Click this switch to activate NAT on this connection.
IGMP Proxy	<p>Internet Group Multicast Protocol (IGMP) is a network-layer protocol used to establish membership in a Multicast group – it is not used to carry user data.</p> <p>Click this switch to have the Zyxel Device act as an IGMP proxy on this connection.</p> <p>This allows the Zyxel Device to get subscribing information and maintain a joined member list for each multicast group. It can reduce multicast traffic significantly.</p>
Apply as Default Gateway	Click this switch to have the Zyxel Device use this WAN interface of this connection as the system default gateway.
Fullcone NAT	<p>Click this switch to enable full cone NAT on this WAN connection.</p> <p>This field is available only when you activate <b>NAT</b>.</p> <p>In full cone NAT, the Zyxel Device maps all outgoing packets from an internal IP address and port to a single IP address and port on the external network. The Zyxel Device also maps packets coming to that external IP address and port to the internal IP address and port.</p>
<p>6RD</p> <p>The 6RD (IPv6 rapid deployment) fields display when you set the <b>IPv6/IPv4 Mode</b> field to <b>IPv4 Only</b>. See <a href="#">IPv6 Rapid Deployment on page 202</a> for more information.</p> <p>Click this switch to tunnel IPv6 traffic from the local network through the ISP's IPv4 network.</p>	
Automatically configured by DHCP	The <b>Automatically configured by DHCP</b> option is configurable only when you set the method of encapsulation to <b>IPoE</b> .
Manually Configured	Select <b>Manually Configured</b> if you have the IPv4 address of the relay server. Otherwise, select <b>Automatically configured by DHCP</b> to have the Zyxel Device detect it automatically through DHCP.
Service Provider IPv6 Prefix	Enter an IPv6 prefix for tunneling IPv6 traffic to the ISP's border relay router and connecting to the native IPv6 Internet.
IPv4 Mask Length	Enter the subnet mask number (1 – 32) for the IPv4 network.
Border Relay IPv4 Address	When you select <b>Manually Configured</b> , specify the relay server's IPv4 address in this field.
<p>DHCP Options (This is available only when you select <b>IPv4 Only</b> or <b>IPv4 IPv6 DualStack</b> in the <b>IPv4/IPv6 Mode</b> field and <b>IPoE</b> in the <b>Encapsulation</b> field.)</p> <p>Note: The available DHCP options may differ by model.</p>	
Request Options	<p>Select <b>Option 42</b> to have the Zyxel Device get NTP time server information from DHCP packets sent from the DHCP server.</p> <p>Select <b>Option 43</b> to have the Zyxel Device get vendor specific information from DHCP packets sent from the DHCP server.</p> <p>Select <b>Option 120</b> to have the Zyxel Device get static route information from DHCP packets sent from the DHCP server.</p> <p>Select <b>Option 121</b> to have the Zyxel Device get SIP server information from DHCP packets sent from the DHCP server.</p>
Sent Options	



Table 45 Network Setting &gt; Broadband &gt; Add or Edit New WAN Interface (Routing Mode) (continued)

LABEL	DESCRIPTION
option 60	Select this and enter the device identity you want the Zyxel Device to add in the DHCP discovery packets that go to the DHCP server.
Vendor ID	Enter the Vendor Class Identifier, such as the type of the hardware or firmware.
option 61	Select this and enter any string that identifies the device.
IAID	Enter the Identity Association Identifier (IAID) of the device, for example, the WAN connection index number.
DUID	Enter the hardware type, a time value and the MAC address of the device.
option 125	Select this to have the Zyxel Device automatically generate and add vendor specific parameters in the DHCP discovery packets that go to the DHCP server.
IPv6 Address (This is available only when you select <b>IPv4 IPv6 DualStack</b> or <b>IPv6 Only</b> in the <b>IPv4/IPv6 Mode</b> field.)	
Obtain an IPv6 Address Automatically	Select <b>Obtain an IPv6 Address Automatically</b> if you want to have the Zyxel Device use the IPv6 prefix from the connected router's Router Advertisement (RA) to generate an IPv6 address.
Static IPv6 Address	Select <b>Static IPv6 Address</b> if you have a fixed IPv6 address assigned by your ISP. When you select this, the following fields appear.
IPv6 Address	Enter an IPv6 IP address that your ISP gave to you for this WAN interface.
Prefix Length	Enter the address prefix length to specify how many most significant bits in an IPv6 address compose the network address.
IPv6 Default Gateway	Enter the IP address of the next-hop gateway. The gateway is a router or switch on the same segment as your Zyxel Device's interfaces. The gateway helps forward packets to their destinations.
IPv6 DNS Server (This is available only when you select <b>IPv4 IPv6 DualStack</b> or <b>IPv6 Only</b> in the <b>IPv4/IPv6 Mode</b> field. Configure the IPv6 DNS server in the following section.)	
Obtain IPv6 DNS Info Automatically	Select <b>Obtain IPv6 DNS Info Automatically</b> to have the Zyxel Device get the IPv6 DNS server addresses from the ISP automatically.
Use Following Static IPv6 DNS Address	Select <b>Use Following Static IPv6 DNS Address</b> to have the Zyxel Device use the IPv6 DNS server addresses you configure manually.
Primary DNS Server	Enter the first IPv6 DNS server address assigned by the ISP.
Secondary DNS Server	Enter the second IPv6 DNS server address assigned by the ISP.
IPv6 Routing Feature (This is available only when you select <b>IPv4 IPv6 DualStack</b> or <b>IPv6 Only</b> in the <b>IPv4/IPv6 Mode</b> field. You can enable IPv6 routing features in the following section.)	
MLD Proxy Enable	Select this check box to have the Zyxel Device act as an MLD proxy on this connection. This allows the Zyxel Device to get subscription information and maintain a joined member list for each multicast group. It can reduce multicast traffic significantly.
Apply as Default Gateway	Select this option to have the Zyxel Device use the WAN interface of this connection as the system default gateway.
DS-Lite	This is available only when you select <b>IPv6 Only</b> in the <b>IPv4/IPv6 Mode</b> field. Enable Dual Stack Lite to let local computers use IPv4 through an ISP's IPv6 network. See <a href="#">Dual Stack Lite on page 202</a> for more information.  Click this switch to enable DS-Lite to let local computers use IPv4 through an ISP's IPv6 network.
Automatically configured by DHCP	Select this to have the Zyxel Device detect the relay server automatically through DHCP.

Table 45 Network Setting &gt; Broadband &gt; Add or Edit New WAN Interface (Routing Mode) (continued)

LABEL	DESCRIPTION
Manually Configured	Select <b>Manually Configured</b> if you have the IPv6 address of the relay server. Otherwise, select <b>Automatically configured by DHCP</b> to have the Zyxel Device detect it automatically through DHCP.
DS-Lite Relay Server IP	Specify the transition router's IPv6 address.
DHCPv6 Option (This is available only when you select <b>IPv6 Only</b> or <b>IPv4 IPv6 DualStack</b> in the <b>IPv4/IPv6 Mode</b> field.)	
IPv6 Address From DHCPv6 Server	Click the switch to let the Zyxel Device send DHCP requests to the DHCPv6 server to obtain an IPv6 address.
Other Information From DHCPv6 Server	Click the switch to have the Zyxel Device get other information, such as DNS information, from DHCPv6 packets sent from the DHCPv6 server. This will be enabled if <b>IPv6 Address From DHCPv6 Server</b> is enabled.
IPv6 MAP	This is available when you edit an IPv6 WAN interface. Slide the switch to the right to create an IPv6 map domain.
Transport Mode	Select <b>MAP-T</b> (Translation) or <b>MAP-E</b> (Encapsulation) based on the ISP deployment.
Setting Mode	Select <b>DHCP S46</b> or <b>Manual</b> to configure the following fields.
Note: The following Prefix/Address fields are used for the address mapping rule of MAP-T or MAP-E.	
BR IPv6 Prefix	This is the IPv6 network address/prefix assigned to the BR, including the prefix length.
Rule IPv6 Prefix	This is the IPv6 network prefix, including the prefix length.
Rule IPv4 Prefix	This is the IPv4 network prefix, including the prefix length.
Note: The following PSID fields are used for the port mapping rule of MAP-T or MAP-E.	
PSID Offset	The Port Set Identifier (PSID) offset specifies the excluded port range. The default <b>PSID Offset</b> is 6; port 0~1023 will be reserved for the system to use.
PSID Length	This specifies the number of sharing ratio. When <b>PSID Length</b> is set to 8, the ports will be separated and assigned for 2^8 MAP CEs to use.
PSID	A Port Set ID ( <b>PSID</b> ) identifies a set of ports assigned to a CE for mapping. <b>PSID</b> should be unique for each CE sharing the IPv4 address.
Cancel	Click <b>Cancel</b> to restore your previously saved settings.
Apply	Click <b>Apply</b> to save your changes.

## Bridge Mode

Click the **Add new WAN Interface** in the **Network Setting > Broadband** screen or the **Edit** icon next to the connection you want to configure. The following example screen displays when you select **Bridge** mode.

**Figure 95** Network Setting > Broadband > Add or Edit New WAN Interface (Bridge Mode)

The following table describes the fields in this screen.

**Table 46** Network Setting > Broadband > Add/Edit New WAN Interface (Bridge Mode)

LABEL	DESCRIPTION
General	
Click this switch to enable the WAN interface.	
Name	Enter a service name of the connection. You can use up to 15 alphanumeric (0-9, a-z, A-Z) and special characters except [ " ], [ ` ], [ ' ], [ < ], [ > ], [ ^ ], [ \$ ], [   ], [ & ], or [ ; ]. Spaces are allowed. This field is read-only if you are editing the WAN interface.
Type	Select <b>VDSL over PTM</b> , <b>ADSL over ATM</b> or <b>Ethernet</b> as the WAN interface type. This field is read-only if you are editing the WAN interface.
Mode	Select <b>Bridge</b> when your ISP provides you more than one IP address and you want the connected computers to get individual IP address from ISP's DHCP server directly. If you select <b>Bridge</b> , you cannot use routing functions, such as QoS, Firewall, DHCP server and NAT on traffic from the selected LAN ports.
VLAN	
Click this switch to enable VLAN on this WAN interface.	
802.1p	IEEE 802.1p defines up to 8 separate traffic types by inserting a tag into a MAC-layer frame that contains bits to define class of service.  Select the IEEE 802.1p priority level (from 0 to 7) to add to traffic through this connection. The greater the number, the higher the priority level.
802.1q	Type the VLAN ID number (from 0 to 4094) for traffic through this connection.
MTU	
MTU	Enter the MTU (Maximum Transfer Unit) size for traffic through this connection.
ATM PVC Configuration (This is available only when you select <b>ADSL over ATM</b> in the <b>Type</b> field.)	
VPI [0-255]	The valid range for the VPI is 0 to 255. Enter the VPI assigned to you.

Table 46 Network Setting &gt; Broadband &gt; Add/Edit New WAN Interface (Bridge Mode) (continued)

LABEL	DESCRIPTION
VCI [32–65535]	The valid range for the VCI is 32 to 65535 (0 to 31 is reserved for local management of ATM traffic). Enter the VCI assigned to you.
Encapsulation	Select the method of multiplexing used by your ISP from the drop-down list box. Choices are: <ul style="list-style-type: none"> <li>• <b>LLC/SNAP-BRIDGING:</b> In LLC encapsulation, bridged PDUs are encapsulated by identifying the type of the bridged media in the SNAP header.</li> <li>• <b>VC/MUX:</b> In VC multiplexing, each protocol is carried on a single ATM virtual circuit (VC). To transport multiple protocols, the Zyxel Device needs separate VCs. There is a binding between a VC and the type of the network protocol carried on the VC. This reduces payload overhead since there is no need to carry protocol information in each Protocol Data Unit (PDU) payload.</li> </ul>
Service Category	Select <b>UBR Without PCR</b> for applications that are non-time sensitive, such as email. Select <b>CBR</b> (Continuous Bit Rate) to specify fixed (always-on) bandwidth for voice or data traffic. Select <b>Non Realtime VBR</b> (non real-time Variable Bit Rate) for connections that do not require closely controlled delay and delay variation. Select <b>Realtime VBR</b> (real-time Variable Bit Rate) for applications with bursty connections that require closely controlled delay and delay variation.
Peak Cell Rate [cells/s]	Divide the DSL line rate (bps) by 424 (the size of an ATM cell) to find the Peak Cell Rate (PCR). This is the maximum rate at which the sender can send cells. Enter the PCR here. This is not available when you set the <b>Service Category</b> to <b>UBR Without PCR</b> .
Sustainable Cell Rate	The Sustain Cell Rate (SCR) sets the average cell rate (long-term) that can be transmitted. Enter the SCR, which must be less than the PCR. Note that system default is 0 cells/sec. This is not available when you set the <b>Service Category</b> to <b>UBR Without PCR</b> or <b>CBR</b> .
Maximum Burst Size [cells]	Maximum Burst Size (MBS) refers to the maximum number of cells that can be sent at the peak rate. Enter the MBS, which is less than 65535. This is not available when you set the <b>Service Category</b> to <b>UBR Without PCR</b> or <b>CBR</b> .
Cancel	Click <b>Cancel</b> to exit this screen without saving any changes.
Apply	Click <b>Apply</b> to save your changes.

## 8.3 Broadband Settings for Ethernet, AON and PON Routers

Use this screen to change your Zyxel Device's Internet access settings. The summary table shows you the configured WAN services (connections) on the Zyxel Device. Use information provided by your ISP to configure WAN settings.

Note: The differences of the broadband screens between Ethernet, AON and PON routers are the type of connections available.

Click **Network Setting > Broadband** to access this screen.

Figure 96 Network Setting &gt; Broadband (Ethernet Routers)

**Broadband**

Cellular Backup

Use this screen to change your Zyxel Device's Internet access settings. The summary table shows you the configured WAN services (connections) on the Zyxel Device. Use information provided by your ISP to configure WAN settings.

[Add New WAN Interface](#)

#	Name	Type	Mode	Encapsulation	802.1p	802.1q	IGMP Proxy	NAT	Default Gateway	IPv6	MLD Proxy	Modify
1	ETHWAN	ETH	Routing	IPoE	N/A	N/A	Y	Y	Y	Y	Y	

Figure 97 Network Setting &gt; Broadband (AON and PON Routers)

**Broadband**

Cellular Backup

Use this screen to change your Zyxel Device's Internet access settings. The summary table shows you the configured WAN services (connections) on the Zyxel Device. Use information provided by your ISP to configure WAN settings.

[Add New WAN Interface](#)

#	Name	Type	Mode	Encapsulation	802.1p	802.1q	IGMP Proxy	NAT	Default Gateway	IPv6	MLD Proxy	Modify
1	GPON	PON	Routing	IPoE	N/A	N/A	Y	Y	Y	Y	Y	

The following table describes the labels in this screen.

Table 47 Network Setting &gt; Broadband

LABEL	DESCRIPTION
Add New WAN Interface	Click this button to create a new connection.
#	This is the index number of the entry.
Name	This is the service name of the connection.
Type	This displays the type of connections available.
Mode	This shows whether the connection is in routing or bridge mode.
Encapsulation	This is the method of encapsulation used by this connection.
802.1p	This indicates the 802.1p priority level assigned to traffic sent through this connection. This displays <b>N/A</b> when there is no priority level assigned.
802.1q	This indicates the VLAN ID number assigned to traffic sent through this connection. This displays <b>N/A</b> when there is no VLAN ID number assigned.
IGMP Proxy	This shows whether the Zyxel Device act as an IGMP proxy on this connection.
NAT	This shows whether NAT is activated or not for this connection.
Default Gateway	This shows whether the Zyxel Device use the WAN interface of this connection as the system default gateway.
IPv6	This shows whether IPv6 is activated or not for this connection. IPv6 is not available when the connection uses the bridging service.

Table 47 Network Setting &gt; Broadband (continued)

LABEL	DESCRIPTION
MLD Proxy	This shows whether Multicast Listener Discovery (MLD) is activated or not for this connection. MLD is not available when the connection uses the bridging service.
Modify	Click the <b>Edit</b> icon to configure the WAN connection. Click the <b>Delete</b> icon to remove the WAN connection.

### 8.3.1 Add or Edit Internet Connection

Click **Add New WAN Interface** in the **Broadband** screen or the Edit icon next to an existing WAN interface to open the following screen. Use this screen to configure a WAN connection. The screen varies depending on the mode, encapsulation, and IPv6 or IPv4 mode you select.

#### Routing Mode

Use **Routing** mode if your ISP give you one IP address only and you want multiple computers to share an Internet account.

The following example screen displays when you select the **Routing** mode and **PPPoE** encapsulation. The screen varies when you select other encapsulation and IPv6 or IPv4 mode.

**Figure 98** Network Setting > Broadband > Add or Edit New WAN Interface (Ethernet Routers Routing Mode)

<
**Add New WAN Interface**

<p style="text-align: center;"><b>General</b> <input checked="" type="checkbox"/></p> <p>Name: <input type="text"/></p> <p>Type: <input type="text" value="Ethernet"/></p> <p>Mode: <input type="text" value="Routing"/></p> <p>Encapsulation: <input type="text" value="IPoE"/></p> <p>IPv4/IPv6 Mode: <input type="text" value="IPv4 IPv6 DualStack"/></p>	<p style="text-align: center;"><b>VLAN</b> <input checked="" type="checkbox"/></p> <p>802.1p: <input type="text" value="0"/></p> <p>802.1q: <input type="text"/> (0~4094)</p> <p style="text-align: center;"><b>MTU</b></p> <p>MTU: <input type="text" value="1500"/></p>
<p style="text-align: center;"><b>IP Address</b></p> <p><input checked="" type="radio"/> Obtain an IP Address Automatically</p> <p><input type="radio"/> Static IP Address</p> <p style="text-align: center;"><b>DNS Server</b></p> <p><input checked="" type="radio"/> Obtain DNS Info Automatically</p> <p><input type="radio"/> Use Following Static DNS Address</p>	<p style="text-align: center;"><b>Routing Feature</b></p> <p>NAT: <input checked="" type="checkbox"/> IGMP Proxy: <input checked="" type="checkbox"/></p> <p>Apply as Default Gateway: <input type="checkbox"/> Fullcone NAT: <input type="checkbox"/></p>
<p style="text-align: center;"><b>DHCP Options</b></p> <p>Request Options</p> <p><input type="checkbox"/> option 42   <input type="checkbox"/> option 43   <input type="checkbox"/> option 120   <input type="checkbox"/> option 121</p> <p>Sent Options</p> <p><input type="checkbox"/> option 60</p> <p>Vendor ID: <input type="text"/></p> <p><input type="checkbox"/> option 61</p> <p>IAID: <input type="text"/></p> <p>DUID: <input type="text"/></p> <p><input type="checkbox"/> option 125</p>	<p style="text-align: center;"><b>IPv6 Address</b></p> <p><input checked="" type="radio"/> Obtain an IPv6 Address Automatically</p> <p><input type="radio"/> Static IPv6 Address</p> <p style="text-align: center;"><b>IPv6 DNS Server</b></p> <p><input checked="" type="radio"/> Obtain IPv6 DNS Info Automatically</p> <p><input type="radio"/> Use Following Static IPv6 DNS Address</p>
<p style="text-align: center;"><b>IPv6 Routing Feature</b></p> <p>MLD Proxy: <input checked="" type="checkbox"/> Apply as Default Gateway: <input checked="" type="checkbox"/></p>	<p style="text-align: center;"><b>DHCPv6 Option</b></p> <p>IPv6 Address From DHCPv6 Server: <input checked="" type="checkbox"/> Other Information From DHCPv6 Server: <input type="checkbox"/></p>

Cancel
Apply

Figure 99 Network Setting > Broadband > Add or Edit New WAN Interface (AON and PON Routers Routing Mode)

<
**Edit WAN Interface**

---

**General**

Name:

Type:

Mode:

Encapsulation:

IPv4/IPv6 Mode:

**PPP Information**

PPP User Name:

PPP Password:

PPP Connection Trigger:  Auto Connect  On Demand

PPPoE Passthrough:

---

**VLAN**

802.1p:

802.1q:  (0~4094)

**MTU**

MTU:

**IP Address**

Obtain an IP Address Automatically

Static IP Address

**DNS Server**

Obtain DNS Info Automatically

Use Following Static DNS Address

---

**Routing Feature**

NAT:  **IGMP Proxy**:

Apply as Default Gateway:  **Fullcone NAT**:

**IPv6 Address**

Obtain an IPv6 Address Automatically

Static IPv6 Address

IPv6 Address:

Prefix Length:

**IPv6 DNS Server**

Obtain IPv6 DNS Info Automatically

Use Following Static IPv6 DNS Address

Primary DNS Server:

Secondary DNS Server:

---

**IPv6 Routing Feature**

MLD Proxy:  **Apply as Default Gateway**:

**DHCPv6 Option**

IPv6 Address From DHCPv6 Server:  **Other Information From DHCPv6 Server**:

Cancel
Apply



The following table describes the labels in this screen.

Table 48 Network Setting > Broadband > Add or Edit New WAN Interface (Routing Mode)


LABEL	DESCRIPTION
General	Click this switch to enable the WAN interface.
Name	Specify a descriptive name for this connection. You can use up to 15 alphanumeric (0-9, a-z, A-Z) and special characters except [ " ], [ ` ], [ ' ], [ < ], [ > ], [ ^ ], [ \$ ], [   ], [ & ], or [ ; ]. Spaces are allowed.  This field is read-only is you are editing the WAN interface.
Type	This field shows <b>Ethernet</b> and indicates an Ethernet connection.  This field is read-only is you are editing the WAN interface.
Mode	Select <b>Routing</b> if your ISP give you one IP address only and you want multiple computers to share an Internet account.
Encapsulation	Select the method of encapsulation used by your ISP from the drop-down list box. This option is available only when you select <b>Routing</b> in the <b>Mode</b> field.  The choices are <b>PPPoE</b> and <b>IPoE</b> .
IPv4/IPv6 Mode	Select <b>IPv4 Only</b> if you want the Zyxel Device to run IPv4 only.  Select <b>IPv4 IPv6 DualStack</b> to allow the Zyxel Device to run IPv4 and IPv6 at the same time.  Select <b>IPv6 Only</b> if you want the Zyxel Device to run IPv6 only.
PPP Information (This is available only when you select <b>PPPoE</b> in the <b>Encapsulation</b> field.)	
PPP User Name	Enter the user name exactly as your ISP assigned. If assigned a name in the form user@domain where domain identifies a service name, then enter both components exactly as given.
PPP Password	Enter the password associated with the user name above. Select <b>password unmask</b> to show your entered password in plain text.
PPP Connection Trigger	Select when to have the Zyxel Device establish the PPP connection.  <b>Auto Connect</b> – select this to not let the connection time out.  <b>On Demand</b> – select this to automatically bring up the connection when the Zyxel Device receives packets destined for the Internet.
Idle Timeout	This value specifies the time in minutes that elapses before the router automatically disconnects from the PPPoE server.  This field is only available if you select <b>On Demand</b> in the <b>PPP Connection Trigger</b> field.
PPPoE Passthrough	This field is available when you select <b>PPPoE</b> encapsulation.  In addition to the Zyxel Device's built-in PPPoE client, you can enable PPPoE pass through to allow up to ten hosts on the LAN to use PPPoE client software on their computers to connect to the ISP through the Zyxel Device. Each host can have a separate account and a public WAN IP address.  PPPoE pass through is an alternative to NAT for application where NAT is not appropriate.  Disable PPPoE pass through if you do not need to allow hosts on the LAN to use PPPoE client software on their computers to connect to the ISP.
VLAN	Click this switch to enable or disable VLAN on this WAN interface. When the switch goes to the right  , the function is enabled. Otherwise, it is not.
802.1p	IEEE 802.1p defines up to 8 separate traffic types by inserting a tag into a MAC-layer frame that contains bits to define class of service.  Select the IEEE 802.1p priority level (from 0 to 7) to add to traffic through this connection. The greater the number, the higher the priority level.
802.1q	Type the VLAN ID number (from 0 to 4094) for traffic through this connection.
MTU	

Table 48 Network Setting &gt; Broadband &gt; Add or Edit New WAN Interface (Routing Mode) (continued)





LABEL	DESCRIPTION
MTU	Enter the MTU (Maximum Transfer Unit) size for traffic through this connection.
IP Address (This is available only when you select <b>IPv4 Only</b> or <b>IPv4 IPv6 DualStack</b> in the <b>IPv4/IPv6 Mode</b> field.)	
Obtain an IP Address Automatically	A static IP address is a fixed IP that your ISP gives you. A dynamic IP address is not fixed; the ISP assigns you a different one each time you connect to the Internet. Select this if you have a dynamic IP address.
Static IP Address	Select this option if the ISP assigned a fixed IP address.
IP Address	Enter the static IP address provided by your ISP.
Subnet Mask	Enter the subnet mask provided by your ISP.  This is available only when you set the <b>Encapsulation</b> to <b>IPoE</b> .
Gateway IP Address	Enter the gateway IP address provided by your ISP.  This is available only when you set the <b>Encapsulation</b> to <b>IPoE</b> .
DNS Server (This is available only when you select <b>IPv4 Only</b> or <b>IPv4 IPv6 DualStack</b> in the <b>IPv4/IPv6 Mode</b> field.)	
	Select <b>Obtain DNS Info Automatically</b> if you want the Zyxel Device to use the DNS server addresses assigned by your ISP.  Select <b>Use Following Static DNS Address</b> if you want the Zyxel Device to use the DNS server addresses you configure manually.
Primary DNS Server	Enter the first DNS server address assigned by the ISP.
Secondary DNS Server	Enter the second DNS server address assigned by the ISP.
Routing Feature (This is available only when you select <b>IPv4 Only</b> or <b>IPv4 IPv6 DualStack</b> in the <b>IPv4/IPv6 Mode</b> field.)	
NAT	Click this switch to activate or deactivate NAT on this connection. When the switch goes to the right  , the function is enabled. Otherwise, it is not.
IGMP Proxy	Internet Group Multicast Protocol (IGMP) is a network-layer protocol used to establish membership in a Multicast group - it is not used to carry user data.  Click this switch to have the Zyxel Device act as an IGMP proxy on this connection. When the switch goes to the right  , the function is enabled. Otherwise, it is not.  This allows the Zyxel Device to get subscribing information and maintain a joined member list for each multicast group. It can reduce multicast traffic significantly.
Apply as Default Gateway	Click this switch to have the Zyxel Device use the WAN interface of this connection as the system default gateway. When the switch goes to the right  , the function is enabled. Otherwise, it is not.
Fullcone NAT Enable	Click this switch to enable or disable full cone NAT on this connection. When the switch goes to the right  , the function is enabled. Otherwise, it is not.  This field is available only when you activate <b>NAT</b> .  In full cone NAT, the Zyxel Device maps all outgoing packets from an internal IP address and port to a single IP address and port on the external network. The Zyxel Device also maps packets coming to that external IP address and port to the internal IP address and port.
DHCP Options (This is available only when you set the <b>Encapsulation</b> to <b>IPoE</b> and select <b>IPv4 Only</b> or <b>IPv4 IPv6 DualStack</b> in the <b>IPv4/IPv6 Mode</b> field.)	
Note: The available DHCP options may differ by model.	

Table 48 Network Setting &gt; Broadband &gt; Add or Edit New WAN Interface (Routing Mode) (continued)

LABEL	DESCRIPTION
Request Options	<p>Select <b>Option 42</b> to have the Zyxel Device get NTP time server information from DHCP packets sent from the DHCP server.</p> <p>Select <b>Option 43</b> to have the Zyxel Device get vendor specific information from DHCP packets sent from the DHCP server.</p> <p>Select <b>Option 120</b> to have the Zyxel Device get static route information from DHCP packets sent from the DHCP server.</p> <p>Select <b>Option 121</b> to have the Zyxel Device get SIP server information from DHCP packets sent from the DHCP server.</p>
Sent Options	
option 60	Select this and enter the device identity you want the Zyxel Device to add in the DHCP discovery packets that go to the DHCP server.
Vendor ID	Enter the Vendor Class Identifier, such as the type of the hardware or firmware.
option 61	Select this and enter any string that identifies the device.
IAID	Enter the Identity Association Identifier (IAID) of the device, for example, the WAN connection index number.
DUID	Enter the hardware type, a time value and the MAC address of the device.
option 125	Select this to have the Zyxel Device automatically generate and add vendor specific parameters in the DHCP discovery packets that go to the DHCP server.
IPv6 Address (This is available only when you select <b>IPv4 IPv6 DualStack</b> or <b>IPv6 Only</b> in the <b>IPv4/IPv6 Mode</b> field.)	
Obtain an IPv6 Address Automatically	Select <b>Obtain an IPv6 Address Automatically</b> if you want to have the Zyxel Device use the IPv6 prefix from the connected router's Router Advertisement (RA) to generate an IPv6 address.
Static IPv6 Address	Select <b>Static IPv6 Address</b> if you have a fixed IPv6 address assigned by your ISP. When you select this, the following fields appear.
IPv6 Address	Enter an IPv6 IP address that your ISP gave to you for this WAN interface.
Prefix Length	Enter the address prefix length to specify how many most significant bits in an IPv6 address compose the network address.
IPv6 Default Gateway	Enter the IP address of the next-hop gateway. The gateway is a router or switch on the same segment as your Zyxel Device's interfaces. The gateway helps forward packets to their destinations.
IPv6 DNS Server (This is available only when you select <b>IPv4 IPv6 DualStack</b> or <b>IPv6 Only</b> in the <b>IPv4/IPv6 Mode</b> field. Configure the IPv6 DNS server in the following section.)	
Obtain IPv6 DNS Info Automatically	Select <b>Obtain IPv6 DNS Info Automatically</b> to have the Zyxel Device get the IPv6 DNS server addresses from the ISP automatically.
Use Following Static IPv6 DNS Address	Select <b>Use Following Static IPv6 DNS Address</b> to have the Zyxel Device use the IPv6 DNS server addresses you configure manually.
Primary DNS Server	Enter the first IPv6 DNS server address assigned by the ISP.
Secondary DNS Server	Enter the second IPv6 DNS server address assigned by the ISP.
IPv6 Routing Feature (This is available only when you select <b>IPv4 IPv6 DualStack</b> or <b>IPv6 Only</b> in the <b>IPv4/IPv6 Mode</b> field. You can enable IPv6 routing features in the following section.)	
MLD Proxy Enable	Select this check box to have the Zyxel Device act as an MLD proxy on this connection. This allows the Zyxel Device to get subscription information and maintain a joined member list for each multicast group. It can reduce multicast traffic significantly.
Apply as Default Gateway	Select this option to have the Zyxel Device use the WAN interface of this connection as the system default gateway.

Table 48 Network Setting &gt; Broadband &gt; Add or Edit New WAN Interface (Routing Mode) (continued)

LABEL	DESCRIPTION
DS-Lite	This is available only when you select <b>IPv6 Only</b> in the <b>IPv4/IPv6 Mode</b> field. Enable Dual Stack Lite to let local computers use IPv4 through an ISP's IPv6 network. See <a href="#">Dual Stack Lite on page 202</a> for more information.  Click this switch to enable DS-Lite to let local computers use IPv4 through an ISP's IPv6 network.
DS-Lite Relay Server IP	Specify the transition router's IPv6 address.
6RD	The 6RD (IPv6 rapid deployment) fields display when you set the <b>IPv6/IPv4 Mode</b> field to <b>IPv4 Only</b> . See <a href="#">IPv6 Rapid Deployment on page 202</a> for more information.  Click this switch to tunnel IPv6 traffic from the local network through the ISP's IPv4 network.
	Select <b>Manually Configured</b> if you have the IPv4 address of the relay server. Otherwise, select <b>Automatically configured by DHCP</b> to have the Zyxel Device detect it automatically through DHCP.  The <b>Automatically configured by DHCP</b> option is configurable only when you set the method of encapsulation to <b>IPoE</b> .
Service Provider IPv6 Prefix	Enter an IPv6 prefix for tunneling IPv6 traffic to the ISP's border relay router and connecting to the native IPv6 Internet.
IPv4 Mask Length	Enter the subnet mask number (1 – 32) for the IPv4 network.
Border Relay IPv4 Address	When you select <b>Manually Configured</b> , specify the relay server's IPv4 address in this field.
DHCPv6 Option (This is available only when you select <b>IPv6 Only</b> or <b>IPv4 IPv6 DualStack</b> in the <b>IPv4/IPv6 Mode</b> field.)	
IPv6 Address From DHCPv6 Server	Click the switch (to the right) to let the Zyxel Device send DHCP requests to the DHCPv6 server to obtain an IPv6 address.
Other Information From DHCPv6 Server	Click the switch (to the right) to have the Zyxel Device get other information, such as DNS information, from DHCPv6 packets sent from the DHCPv6 server.  This will be enabled if <b>IPv6 Address From DHCPv6 Server</b> is enabled.
Cancel	Click <b>Cancel</b> to restore your previously saved settings.
Apply	Click <b>Apply</b> to save your changes.

## Bridge Mode

Click the **Add new WAN Interface** in the **Network Setting > Broadband** screen or the **Edit** icon next to the connection you want to configure. The following example screen displays when you select **Bridge** mode.

**Figure 100** Network Setting > Broadband > Add or Edit New WAN Interface (Bridge Mode)

The following table describes the fields in this screen.

**Table 49** Network Setting > Broadband > Add or Edit New WAN Interface (Bridge Mode)

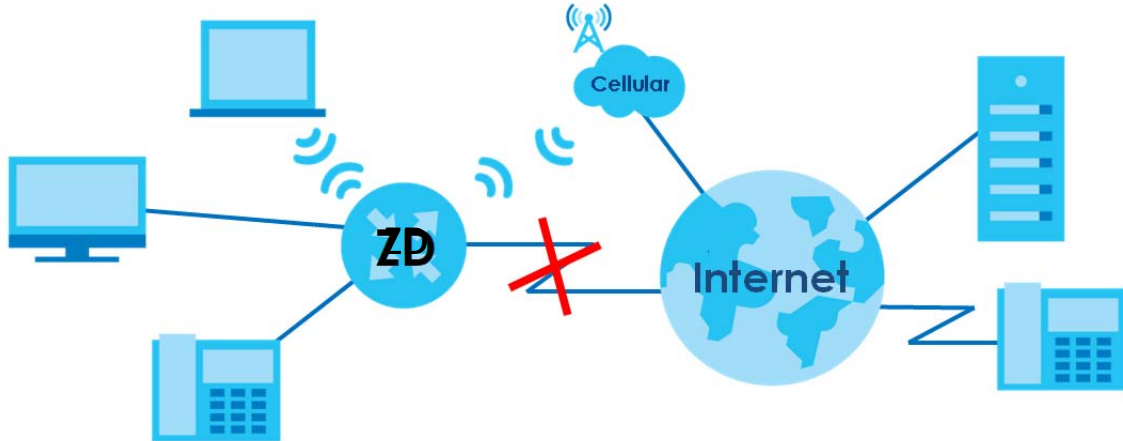
LABEL	DESCRIPTION
General	Click this switch to enable the interface.
Name	Enter a service name of the connection. You can use up to 15 alphanumeric (0-9, a-z, A-Z) and special characters except [ " ], [ ` ], [ ' ], [ < ], [ > ], [ ^ ], [ \$ ], [   ], [ & ], or [ ; ]. Spaces are allowed. This field is read-only is you are editing the WAN interface.
Type	This field shows <b>Ethernet</b> and indicates an Ethernet connection. This field is read-only is you are editing the WAN interface.
Mode	Select <b>Bridge</b> when your ISP provides you more than one IP address and you want the connected computers to get individual IP address from ISP's DHCP server directly. If you select <b>Bridge</b> , you cannot use routing functions, such as QoS, Firewall, DHCP server and NAT on traffic from the selected LAN ports.
VLAN	Click this switch to enable VLAN on this WAN interface.
802.1p	IEEE 802.1p defines up to 8 separate traffic types by inserting a tag into a MAC-layer frame that contains bits to define class of service. Select the IEEE 802.1p priority level (from 0 to 7) to add to traffic through this connection. The greater the number, the higher the priority level.
802.1q	Type the VLAN ID number (from 0 to 4094) for traffic through this connection.
Cancel	Click <b>Cancel</b> to exit this screen without saving any changes.
Apply	Click <b>Apply</b> to save your changes.

## 8.4 Cellular Backup

The USB port of the Zyxel Device allows you to attach a cellular dongle to wirelessly connect to a cellular network for Internet access. You can have the Zyxel Device use the cellular WAN connection as a

backup to keep you online if the primary WAN connection fails for **Consecutive Fail** times. Consult your cellular service provider to configure the settings in this screen. Disconnect the Fiber port to use the cellular dongle as your primary WAN connection, as the Zyxel Device automatically uses a wired WAN connection when available.

**Figure 101** Internet Access Application: Cellular WAN



Use this screen to configure your cellular settings. Click **Network Setting > Broadband > Cellular Backup**.

The actual data rate you obtain varies depending on the cellular card you use, the signal strength to the service provider's base station, and so on.

Note: Entering a wrong PIN code three times will lock the SIM card in your cellular dongle.

Note: If you select **Drop** in the **Current Cellular Connection** field, the Zyxel Device will drop the cellular WAN connection when the **Time Budget** or **Data Budget** is reached. It may take some time for the cellular WAN connection to be disconnected when the **Time Budget** or **Data Budget** is reached.

**Figure 102** Network Setting > Broadband > Cellular Backup

The USB port of the Zyxel Device allows you to attach a cellular dongle to wirelessly connect to a cellular network for Internet access. You can have the Zyxel Device use the cellular WAN connection as a backup to keep you online if the primary WAN connection fails for **Consecutive Fail** times. Consult your cellular service provider to configure the settings in this screen. Disconnect the DSL/Ethernet/Fiber WAN ports to use the cellular dongle as your primary WAN connection, as the Zyxel Device automatically uses a wired WAN connection when available.

### General

Cellular Backup

Ping Check

Check Cycle Every  (20~180 Sec)

Consecutive Fail  (2~5 times)

Ping Default Gateway

Ping Host  (Host name or IP address)

### Cellular Connection Settings

Card Description N/A

Username  (Optional)

Password   (Optional)

Authentication  ▼

PIN  (Optional) (Only for unlock PIN next time)  
(PIN remaining authentication times)

Dial String

APN

Connection  ▼

Obtain an IP Address Automatically

Use the Following Static IP Address

Obtain DNS Info Dynamically

Use the Following Static DNS IP Address

Enable e-mail Notification

Note

Entering a wrong PIN code three times will lock the SIM card in your cellular dongle.

Figure 103 Network > Broadband > Cellular Backup (Budget Setup)

**Budget Setup**

Enable Budget Control

Time Budget  hours per month

Data Budget  Mbytes  per month

Data Budget  kPackets  per month

Reset all budget counters on  day of the month

**Reset time and data budget counters**

Actions before over budget

Data Budget  % of time budget

Data Budget  % of data budget (Mbytes)

Data Budget  % of data budget (Packets)

Actions when over budget

Current Cellular Connection

Actions

Enable e-mail Notification

Enable Log: Interval  minutes

Note

If you select **Drop** in the **Current Cellular Connection** field, the will drop the Zyxel Device cellular WAN connection when the **Time Budget** or **Data Budget** is reached. It may take some time for the cellular WAN connection to be disconnected when the **Time Budget** or **Data Budget** is reached.

**Cancel** **Apply**

The following table describes the labels in this screen.

Table 50 Network Setting > Broadband > Cellular Backup

LABEL	DESCRIPTION
General	
Cellular Backup	Click this switch to have the Zyxel Device use the cellular connection as your WAN or a backup when the wired WAN connection fails.
Ping Check	Click this switch to ping check the connection status of your WAN. You can configure the frequency of the ping check and number of consecutive failures before triggering cellular backup.
Check Cycle	Enter the frequency of the ping check in this field.
Consecutive Fail	Enter how many consecutive failures are required before cellular backup is triggered.
Ping Default Gateway	Select this to have the Zyxel Device ping the WAN interface's default gateway IP address.



Table 50 Network Setting &gt; Broadband &gt; Cellular Backup (continued)

LABEL	DESCRIPTION
Ping Host	Select this to have the Zyxel Device ping the particular host name or IP address you typed in this field.
Cellular Connection Settings	
Card Description	This field displays the manufacturer and model name of your cellular card if you inserted one in the Zyxel Device. Otherwise, it displays <b>N/A</b> .
Username	Enter the user name (of up to 64 alphanumeric (0-9, a-z, A-Z) and special characters, including spaces) given to you by your service provider.
Password	Enter the password (of up to 64 alphanumeric (0-9, a-z, A-Z) and special characters, including spaces) associated with the user name above.
Authentication	The Zyxel Device supports PAP (Password Authentication Protocol) and CHAP (Challenge Type Handshake Authentication Protocol). In PAP, peers identify themselves with a user name and password. In CHAP, additionally to user name and password the Zyxel Device sends regular challenges to make sure an intruder has not replaced a peer. CHAP is more secure than PAP; however, PAP is available on more platforms. Select an authentication protocol (Auto, CHAP or PAP). Contact your service provider for the correct authentication type.
PIN	A PIN (Personal Identification Number) code is a key to a cellular card. Without the PIN code, you cannot use the cellular card.  If your ISP enabled PIN code authentication, enter the 4-digit PIN code (0000 for example) provided by your ISP. If you enter the PIN code incorrectly, the cellular card may be blocked by your ISP and you cannot use the account to access the Internet.  If your ISP disabled PIN code authentication, leave this field blank.
Dial String	Enter the phone number (dial string) used to dial up a connection to your service provider's base station. Your ISP should provide the phone number.  For example, *99# is the dial string to establish a GPRS or cellular connection in Taiwan.
APN	Enter the APN (Access Point Name) provided by your service provider. Connections with different APNs may provide different services (such as Internet access or MMS (Multi-Media Messaging Service)) and charge method.  You can enter up to 32 printable characters except [ " ], [ ` ], [ ' ], [ < ], [ > ], [ ^ ], [ \$ ], [   ], [ & ], or [ ; ]. Spaces are allowed.
Connection	Select <b>Nailed UP</b> if you do not want the connection to time out.  Select <b>On Demand</b> if you do not want the connection up all the time and specify an idle time-out in the <b>Max Idle Timeout</b> field.
Max Idle Timeout	This value specifies the time in minutes that elapses before the Zyxel Device automatically disconnects from the ISP.
Obtain an IP Address Automatically	Select this option if your ISP did not assign you a fixed IP address.
Use the Following Static IP Address	Select this option if the ISP assigned a fixed IP address.
IP Address	Enter your WAN IP address in this field if you selected <b>Use the following static IP address</b> .
Subnet Mask	Enter the subnet mask of the IP address.
Obtain DNS Info Dynamically	Select this to have the Zyxel Device get the DNS server addresses from the ISP automatically.
Use the Following Static DNS IP Address	Select this to have the Zyxel Device use the DNS server addresses you configure manually.
Primary DNS Server	Enter the first DNS server address assigned by the ISP.

Table 50 Network Setting &gt; Broadband &gt; Cellular Backup (continued)


LABEL	DESCRIPTION
Secondary DNS Server	Enter the second DNS server address assigned by the ISP.
Enable e-mail Notification	Select this to enable the email notification function. The Zyxel Device will email you a notification when the cellular connection is up.
Mail Account	Select an email address you have configured in <b>Maintenance &gt; E-mail Notification</b> . The Zyxel Device uses the corresponding mail server to send notifications.  You must have configured a mail server already in the <b>Maintenance &gt; E-mail Notification</b> screen.
Cellular Backup e-mail Title	Enter a title that you want to be in the subject line of the email notifications that the Zyxel Device sends.
Send Notification to E-mail	Notifications are sent to the email address specified in this field. If this field is left blank, notifications cannot be sent through email.
Click this  to show the advanced cellular backup settings.	
Budget Setup	
Enable Budget Control	Click this switch to set a monthly limit for the user account of the installed cellular card.  You can set a limit on the total traffic and/or call time. The Zyxel Device takes the actions you specified when a limit is exceeded during the month.
Time Budget	Select this and specify the amount of time (in hours) that the cellular connection can be used within one month. If you change the value after you configure and enable budget control, the Zyxel Device resets the statistics.
Data Budget (Mbytes)	Select this and specify how much downstream and/or upstream data (in Mega bytes) can be transmitted through the cellular connection within one month.  Select <b>Download/Upload</b> to set a limit on the total traffic in both directions.  Select <b>Download</b> to set a limit on the downstream traffic (from the ISP to the Zyxel Device).  Select <b>Upload</b> to set a limit on the upstream traffic (from the Zyxel Device to the ISP).  If you change the value after you configure and enable budget control, the Zyxel Device resets the statistics.
Data Budget (kPackets)	Select this and specify how much downstream and/or upstream data (in k Packets) can be transmitted through the cellular connection within one month.  Select <b>Download/Upload</b> to set a limit on the total traffic in both directions.  Select <b>Download</b> to set a limit on the downstream traffic (from the ISP to the Zyxel Device).  Select <b>Upload</b> to set a limit on the upstream traffic (from the Zyxel Device to the ISP).  If you change the value after you configure and enable budget control, the Zyxel Device resets the statistics.
Reset all budget counters on	Select the date on which the Zyxel Device resets the budget every month. Select <b>last</b> if you want the Zyxel Device to reset the budget on the last day of the month. Select <b>specific</b> and enter the number of the date you want the Zyxel Device to reset the budget.
Reset time and data budget counters	Click this button to reset the time and data budgets immediately. The count starts over with the cellular connection's full configured monthly time and data budgets. This does not affect the normal monthly budget restart; so if you configured the time and data budget counters to reset on the second day of the month and you use this button on the first, the time and data budget counters will still reset on the second.
Actions before over budget	Specify the actions the Zyxel Device takes before the time or data limit exceeds.

Table 50 Network Setting &gt; Broadband &gt; Cellular Backup (continued)

LABEL	DESCRIPTION
Data Budget % of time budget/data budget (Mbytes)/data budget (kPackets)	Select the check boxes and enter a number from 1 to 99 in the percentage fields. If you change the value after you configure and enable budget control, the Zyxel Device resets the statistics.
Actions when over budget	Specify the actions the Zyxel Device takes when the time or data limit is exceeded.
Current Cellular Connection	Select <b>Keep</b> to maintain an existing cellular connection or <b>Drop</b> to disconnect it.
Actions	
Enable e-mail Notification	Click this switch to enable the email notification function. The Zyxel Device will email you a notification whenever over budget occurs.
Mail Account	Select an email address you have configured in <b>Maintenance &gt; E-mail Notification</b> . The Zyxel Device uses the corresponding mail server to send notifications. You must have configured a mail server already in the <b>Maintenance &gt; E-mail Notification</b> screen.
Cellular Backup e- mail Title	Enter a title that you want to be in the subject line of the email notifications that the Zyxel Device sends.
Send Notification to E-mail	Notifications are sent to the email address specified in this field. If this field is left blank, notifications cannot be sent through email.
Enable Log	Select this to and enter the <b>Interval</b> of how many minutes you want the Zyxel Device to email you.
Cancel	Click <b>Cancel</b> to discard any changes to the settings.
Apply	Click <b>Apply</b> to save your changes.

## 8.5 Broadband Advanced Screen

Use the **Advanced** screen to enable or disable ADSL over PTM, Annex M, DSL PhyR, and SRA (Seamless Rate Adaptation) functions. The Zyxel Device supports the PhyR retransmission scheme. PhyR is a retransmission scheme designed to provide protection against noise on the DSL line. It improves voice, video and data transmission resilience by utilizing a retransmission buffer. It also lists ITU-T G.993.2 standard VDSL profiles you can comply with.

ITU-T G.993.2 standard defines a wide range of settings for various parameters, some of which are encompassed in profiles as shown in the next table.

Note: This features is not available on all models. See [Section 1.1 on page 19](#) for more information.

Note: If the settings in the screen are changed, the Zyxel Device will re-establish the DSL connections.

Table 51 VDSL Profiles

PROFILE	BANDWIDTH (MHZ)	NUMBER OF DOWNSTREAM CARRIERS	CARRIER BANDWIDTH (KHZ)	POWER (DBM)	MAX. DOWNSTREAM THROUGHPUT (MBIT/S)
8a	8.832	2048	4.3125	17.5	50
8b	8.832	2048	4.3125	20.5	50
8c	8.5	1972	4.3125	11.5	50
8d	8.832	2048	4.3125	14.5	50
12a	12	2783	4.3125	14.5	68
12b	12	2783	4.3125	14.5	68
17a	17.664	4096	4.3125	14.5	100
35a	30.000	3479	4.3125	14.5	100
35b	35.328	8192	4.3125	17.0	300

Click **Network Setting > Broadband > Advanced** to display the following screen.

Figure 104 Network Setting &gt; Broadband &gt; Advanced

## Broadband

BroadbandCellular BackupAdvanced

Use the **Advanced** screen to enable or disable ADSL over PTM, Annex M, DSL PhyR, and SRA (Seamless Rate Adaptation) functions. The Zyxel Device supports the PhyR retransmission scheme. PhyR is a retransmission scheme designed to provide protection against noise on the DSL line. It improves voice, video and data transmission resilience by utilizing a retransmission buffer. It also lists ITU-T G.993.2 standard VDSL profiles you can comply with.

### DSL Capabilities

PhyR US	<input type="checkbox"/>
PhyR DS	<input checked="" type="checkbox"/>
Bitswap	<input checked="" type="checkbox"/>
SRA	<input checked="" type="checkbox"/>

### DSL Modulation

PTM over ADSL	<input checked="" type="checkbox"/>
G.dmt	<input checked="" type="checkbox"/>
G.lite	<input checked="" type="checkbox"/>
T1.413	<input checked="" type="checkbox"/>
ADSL2	<input checked="" type="checkbox"/>
Annex L	<input checked="" type="checkbox"/>
ADSL2+	<input checked="" type="checkbox"/>
Annex M	<input checked="" type="checkbox"/>
VDSL2	<input checked="" type="checkbox"/>

### VDSL Profile

8a Enable	<input checked="" type="checkbox"/>
8b Enable	<input checked="" type="checkbox"/>
8c Enable	<input checked="" type="checkbox"/>
8d Enable	<input checked="" type="checkbox"/>
12a Enable	<input checked="" type="checkbox"/>
12b Enable	<input checked="" type="checkbox"/>
17a Enable	<input checked="" type="checkbox"/>
30a Enable	<input type="checkbox"/>
35b Enable	<input checked="" type="checkbox"/>
US0	<input checked="" type="checkbox"/>

Cancel Apply

The following table describes the labels in this screen.

Table 52 Network Setting > Broadband > Advanced

LABEL	DESCRIPTION
DSL Capabilities	
PhyR US	Enable or disable <b>PhyR US</b> (upstream) for upstream transmission to the WAN. PhyR US should be enabled if data being transmitted upstream is sensitive to noise. However, enabling PhyR US can decrease the US line rate. Enabling or disabling PhyR will require the CPE to retrain. For PhyR to function, the DSLAM must also support PhyR and have it enabled.
PhyR DS	Enable or disable <b>PhyR DS</b> (downstream) for downstream transmission from the WAN. PhyR DS should be enabled if data being transmitted downstream is sensitive to noise. However, enabling PhyR DS can decrease the DS line rate. Enabling or disabling PhyR will require the CPE to retrain. For PhyR to function, the DSLAM must also support PhyR and have it enabled.
PhyR US/DS	Enable or disable <b>PhyR US/DS</b> (upstream/downstream) for both upstream and downstream transmission to the WAN. PhyR US should be enabled if data being transmitted upstream is sensitive to noise. However, enabling PhyR US can decrease the US line rate. Enabling or disabling PhyR will require the CPE to retrain. For PhyR to function, the DSLAM must also support PhyR and have it enabled.
Bitswap	Select <b>Enable</b> to allow the Zyxel Device to adapt to line changes when you are using G.dmt.  Bit-swapping is a way of keeping the line more stable by constantly monitoring and redistributing bits between channels.
SRA	Enable or disable Seamless Rate Adaption (SRA). Select <b>Enable</b> to have the Zyxel Device automatically adjust the connection's data rate according to line conditions without interrupting service.
DSL Modulation	
PTM over ADSL	Select <b>Enable</b> to use PTM over ADSL. Since PTM has less overhead than ATM, some ISPs use this for better performance.
G.Dmt	ITU G.992.1 (better known as G.dmt) is an ITU standard for ADSL using discrete multitone modulation. G.dmt full-rate ADSL expands the usable bandwidth of existing copper telephone lines, delivering high-speed data communications at rates up to 8 Mbit/s downstream and 1.3 Mbit/s upstream.
G.lite	ITU G.992.2 (better known as G.lite) is an ITU standard for ADSL using discrete multitone modulation. G.lite does not strictly require the use of DSL filters, but like all variants of ADSL generally functions better with splitters.
T1.413	ANSI T1.413 is a technical standard that defines the requirements for the single asymmetric digital subscriber line (ADSL) for the interface between the telecommunications network and the customer installation in terms of their interaction and electrical characteristics.
ADSL2	It optionally extends the capability of basic ADSL in data rates to 12 Mbit/s downstream and, depending on Annex version, up to 3.5 Mbit/s upstream (with a mandatory capability of ADSL2 transceivers of 8 Mbit/s downstream and 800 kbit/s upstream).
Annex L	Annex L is an optional specification in the ITU-T ADSL2 recommendation G.992.3 titled Specific requirements for a Reach Extended ADSL2 (READSL2) system operating in the frequency band above POTS, therefore it is often referred to as Reach Extended ADSL2 or READSL2. The main difference between this specification and commonly deployed Annex A is the maximum distance that can be used. The power of the lower frequencies used for transmitting data is boosted up to increase the reach of this signal up to 7 kilometers (23,000 ft).
ADSL2+	ADSL2+ extends the capability of basic ADSL by doubling the number of downstream channels. The data rates can be as high as 24 Mbit/s downstream and up to 1.4 Mbit/s upstream depending on the distance from the DSLAM to the customer's premises.
Annex M	Annex M is an optional specification in ITU-T recommendations G.992.3 (ADSL2) and G.992.5 (ADSL2+), also referred to as ADSL2 M and ADSL2+ M. This specification extends the capability of commonly deployed Annex A by more than doubling the number of upstream bits. The data rates can be as high as 12 or 24 Mbit/s downstream and 3 Mbit/s upstream depending on the distance from the DSLAM to the customer's premises.

Table 52 Network Setting &gt; Broadband &gt; Advanced (continued)

LABEL	DESCRIPTION
Annex M/J	Annex M and Annex J are specified in ITU-T recommendations G.992.3 (ADSL2) and G.992.5 (ADSL2+). Annex M and Annex J enhance the capabilities of Annex A and Annex B by increasing the upstream transmission data rate, but slightly reduce the downstream data rates as a trade-off. Annex M supports data rates of up to 12 Mbit/s downstream and 3.5 Mbit/s upstream for ADSL2, and up to 24 Mbit/s downstream and 2.5 Mbit/s upstream for ADSL2+. Annex J supports data rates of up to 12 Mbit/s downstream and 3.5 Mbit/s upstream for ADSL2, and up to 24 Mbit/s downstream and 3.5 Mbit/s upstream for ADSL2+. However, the actual downstream/upstream data rates depend on the distance from the ISP DSLAM to the Zyxel Device and the quality of your telephone line. Click the switch to enable the Zyxel Device to use Annex M for Zyxel Device models that use POTS WAN connection, and use Annex J for Zyxel Device models that use ISDN WAN connection.
VDSL2	VDSL2 (Very High Speed Digital Subscriber Line 2) is the second generation of the VDSL standard (which is currently denoted VDSL1). VDSL2 allows a frequency band of up to 30MHz and transmission rates of up to 100 Mbps in each direction. VDSL2 is defined in G.993.2.
VDSL Profile	VDSL2 profiles differ in the width of the frequency band used to transmit the broadband signal. Profiles that use a wider frequency band can deliver higher maximum speeds.
8a, 8b, 8c, 8d, 12a, 12b, 17a, 30a, 35b US0	The G.993.2 VDSL standard defines a wide range of profiles that can be used in different VDSL deployment settings, such as in a central office, a street cabinet or a building.  The Zyxel Device must comply with at least one profile specified in G.993.2. but compliance with more than one profile is allowed.
Cancel	Click <b>Cancel</b> to return to the previous configuration.
Apply	Click <b>Apply</b> to save your changes back to the Zyxel Device.

## 8.6 Backup WAN

Use this screen to have the **LAN/WAN** port on the Zyxel Device ports panel to act as an Ethernet WAN port. The Ethernet WAN connection has priority over the DSL WAN connection.

It's not enough to just enable the fourth LAN port as a WAN port here. You must also go to **Network Setting > Broadband** screen and create a new interface for it with the **Type** as **Ethernet** and **Encapsulation** as **IPoE**. It's suggested to enable NAT.

Note: The Ethernet WAN connection has priority over the DSL connection. See [Section 1.2.1 on page 22](#) for the Zyxel Device WAN priority.

Click **Network Setting > Broadband > Backup WAN** to display the following screen.

**Figure 105** Network Setting > Broadband > Backup WAN

The following table describes the fields in this screen.

**Table 53** Network Setting > Broadband > Backup WAN

LABEL	DESCRIPTION
State:	Click this switch to enable backup WAN to have the <b>LAN/WAN</b> port act as an Ethernet WAN port. Otherwise, the <b>LAN/WAN</b> port remains as a LAN port.
Cancel	Click <b>Cancel</b> to exit this screen without saving any changes.
Apply	Click <b>Apply</b> to save your changes.

## 8.7 Technical Reference

The following section contains additional technical information about the Zyxel Device features described in this chapter.

### Encapsulation

Be sure to use the encapsulation method required by your ISP. The Zyxel Device can work in bridge mode or routing mode. When the Zyxel Device is in routing mode, it supports the following methods.

#### IP over Ethernet

IP over Ethernet (IPoE) is an alternative to PPPoE. IP packets are being delivered across an Ethernet network, without using PPP encapsulation. They are routed between the Ethernet interface and the WAN interface and then formatted so that they can be understood in a bridged environment. For instance, it encapsulates routed Ethernet frames into bridged Ethernet cells.

#### PPP over ATM (PPPoA)

PPPoA stands for Point to Point Protocol over ATM Adaptation Layer 5 (AAL5). A PPPoA connection functions like a dial-up Internet connection. The Zyxel Device encapsulates the PPP session based on RFC1483 and sends it through an ATM PVC (Permanent Virtual Circuit) to the Internet Service Provider's (ISP) DSLAM (digital access multiplexer). Please refer to RFC 2364 for more information on PPPoA. Refer to RFC 1661 for more information on PPP.



## PPP over Ethernet (PPPoE)

Point-to-Point Protocol over Ethernet (PPPoE) provides access control and billing functionality in a manner similar to dial-up services using PPP. PPPoE is an IETF standard (RFC 2516) specifying how a personal computer (PC) interacts with a broadband modem (DSL, cable, WiFi, and so on) connection.

For the service provider, PPPoE offers an access and authentication method that works with existing access control systems (for example RADIUS).

One of the benefits of PPPoE is the ability to let you access one of multiple network services, a function known as dynamic service selection. This enables the service provider to easily create and offer new IP services for individuals.

Operationally, PPPoE saves significant effort for both you and the ISP or carrier, as it requires no specific configuration of the broadband modem at the customer site.

By implementing PPPoE directly on the Zyxel Device (rather than individual computers), the computers on the LAN do not need PPPoE software installed, since the Zyxel Device does that part of the task. Furthermore, with NAT, all of the LANs' computers will have access.

## RFC 1483

RFC 1483 describes two methods for Multiprotocol Encapsulation over ATM Adaptation Layer 5 (AAL5). The first method allows multiplexing of multiple protocols over a single ATM virtual circuit (LLC-based multiplexing) and the second method assumes that each protocol is carried over a separate ATM virtual circuit (VC-based multiplexing). Please refer to RFC 1483 for more detailed information.

## Multiplexing

There are two conventions to identify what protocols the virtual circuit (VC) is carrying. Be sure to use the multiplexing method required by your ISP.

### VC-based Multiplexing

In this case, by prior mutual agreement, each protocol is assigned to a specific virtual circuit; for example, VC1 carries IP, etc. VC-based multiplexing may be dominant in environments where dynamic creation of large numbers of ATM VCs is fast and economical.

### LLC-based Multiplexing

In this case one VC carries multiple protocols with protocol identifying information being contained in each packet header. Despite the extra bandwidth and processing overhead, this method may be advantageous if it is not practical to have a separate VC for each carried protocol, for example, if charging heavily depends on the number of simultaneous VCs.

## Traffic Shaping

Traffic Shaping is an agreement between the carrier and the subscriber to regulate the average rate and fluctuations of data transmission over an ATM network. This agreement helps eliminate congestion, which is important for transmission of real time data such as audio and video connections.

Peak Cell Rate (PCR) is the maximum rate at which the sender can send cells. This parameter may be lower (but not higher) than the maximum line speed. 1 ATM cell is 53 bytes (424 bits), so a maximum

speed of 832Kbps gives a maximum PCR of 1962 cells/sec. This rate is not guaranteed because it is dependent on the line speed.

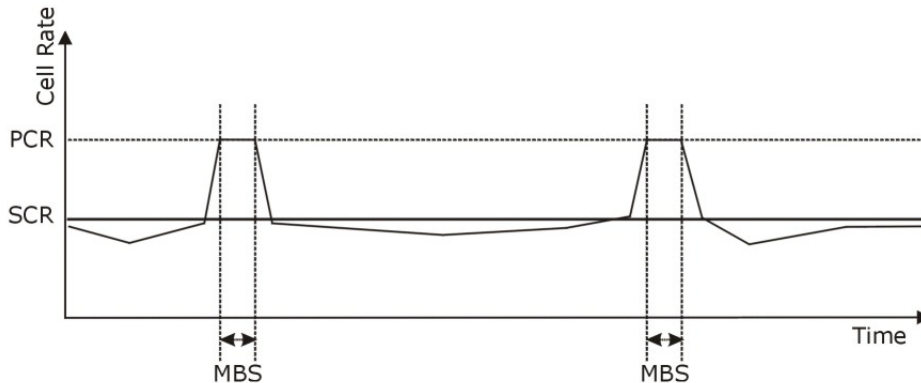
Sustained Cell Rate (SCR) is the mean cell rate of each bursty traffic source. It specifies the maximum average rate at which cells can be sent over the virtual connection. SCR may not be greater than the PCR.

Maximum Burst Size (MBS) is the maximum number of cells that can be sent at the PCR. After MBS is reached, cell rates fall below SCR until cell rate averages to the SCR again. At this time, more cells (up to the MBS) can be sent at the PCR again.

If the PCR, SCR or MBS is set to the default of "0", the system will assign a maximum value that correlates to your upstream line rate.

The following figure illustrates the relationship between PCR, SCR and MBS.

**Figure 106** Example of Traffic Shaping



## ATM Traffic Classes

These are the basic ATM traffic classes defined by the ATM Forum Traffic Management 4.0 Specification.

### Constant Bit Rate (CBR)

Constant Bit Rate (CBR) provides fixed bandwidth that is always available even if no data is being sent. CBR traffic is generally time-sensitive (does not tolerate delay). CBR is used for connections that continuously require a specific amount of bandwidth. A PCR is specified and if traffic exceeds this rate, cells may be dropped. Examples of connections that need CBR would be high-resolution video and voice.

### Variable Bit Rate (VBR)

The Variable Bit Rate (VBR) ATM traffic class is used with bursty connections. Connections that use the Variable Bit Rate (VBR) traffic class can be grouped into real time (VBR-RT) or non-real time (VBR-nRT) connections.

The VBR-RT (real-time Variable Bit Rate) type is used with bursty connections that require closely controlled delay and delay variation. It also provides a fixed amount of bandwidth (a PCR is specified) but is only available when data is being sent. An example of an VBR-RT connection would be video conferencing. Video conferencing requires real-time data transfers and the bandwidth requirement varies in proportion to the video image's changing dynamics.

The VBR-nRT (non real-time Variable Bit Rate) type is used with bursty connections that do not require closely controlled delay and delay variation. It is commonly used for "bursty" traffic typical on LANs. PCR and MBS define the burst levels, SCR defines the minimum level. An example of an VBR-nRT connection would be non-time sensitive data file transfers.

#### Unspecified Bit Rate (UBR)

The Unspecified Bit Rate (UBR) ATM traffic class is for bursty data transfers. However, UBR does not guarantee any bandwidth and only delivers traffic when the network has spare bandwidth. An example application is background file transfer.

## IP Address Assignment

A static IP is a fixed IP that your ISP gives you. A dynamic IP is not fixed; the ISP assigns you a different one each time. The Single User Account feature can be enabled or disabled if you have either a dynamic or static IP. However, the encapsulation method assigned influences your choices for IP address and default gateway.

## Introduction to VLANs

A Virtual Local Area Network (VLAN) allows a physical network to be partitioned into multiple logical networks. Devices on a logical network belong to one group. A device can belong to more than one group. With VLAN, a device cannot directly talk to or hear from devices that are not in the same groups; the traffic must first go through a router.

In Multi-Tenant Unit (MTU) applications, VLAN is vital in providing isolation and security among the subscribers. When properly configured, VLAN prevents one subscriber from accessing the network resources of another on the same LAN, thus a user will not see the printers and hard disks of another user in the same building.

VLAN also increases network performance by limiting broadcasts to a smaller and more manageable logical broadcast domain. In traditional switched environments, all broadcast packets go to each and every individual port. With VLAN, all broadcasts are confined to a specific broadcast domain.

## Introduction to IEEE 802.1Q Tagged VLAN

A tagged VLAN uses an explicit tag (VLAN ID) in the MAC header to identify the VLAN membership of a frame across bridges – they are not confined to the switch on which they were created. The VLANs can be created statically by hand or dynamically through GVRP. The VLAN ID associates a frame with a specific VLAN and provides the information that switches need to process the frame across the network. A tagged frame is 4 bytes longer than an untagged frame and contains 2 bytes of TPID (Tag Protocol Identifier), residing within the type/length field of the Ethernet frame) and 2 bytes of TCI (Tag Control Information), starts after the source address field of the Ethernet frame).

The CFI (Canonical Format Indicator) is a single-bit flag, always set to zero for Ethernet switches. If a frame received at an Ethernet port has a CFI set to 1, then that frame should not be forwarded as it is to an untagged port. The remaining twelve bits define the VLAN ID, giving a possible maximum number of 4,096 VLANs. Note that user priority and VLAN ID are independent of each other. A frame with VID (VLAN Identifier) of null (0) is called a priority frame, meaning that only the priority level is significant and the default VID of the ingress port is given as the VID of the frame. Of the 4096 possible VIDs, a VID of 0 is

used to identify priority frames and value 4095 (FFF) is reserved, so the maximum possible VLAN configurations are 4,094.

TPID	User Priority	CFI	VLAN ID
2 Bytes	3 Bits	1 Bit	12 Bits

## Multicast

IP packets are transmitted in either one of two ways – Unicast (1 sender – 1 recipient) or Broadcast (1 sender – everybody on the network). Multicast delivers IP packets to a group of hosts on the network – not everybody and not just 1.

Internet Group Multicast Protocol (IGMP) is a network-layer protocol used to establish membership in a Multicast group - it is not used to carry user data. IGMP version 2 (RFC 2236) is an improvement over version 1 (RFC 1112) but IGMP version 1 is still in wide use. If you would like to read more detailed information about interoperability between IGMP version 2 and version 1, please see sections 4 and 5 of RFC 2236. The class D IP address is used to identify host groups and can be in the range 224.0.0.0 to 239.255.255.255. The address 224.0.0.0 is not assigned to any group and is used by IP multicast computers. The address 224.0.0.1 is used for query messages and is assigned to the permanent group of all IP hosts (including gateways). All hosts must join the 224.0.0.1 group in order to participate in IGMP. The address 224.0.0.2 is assigned to the multicast routers group.

At start up, the Zyxel Device queries all directly connected networks to gather group membership. After that, the Zyxel Device periodically updates this information.

## DNS Server Address Assignment

Use Domain Name System (DNS) to map a domain name to its corresponding IP address and vice versa, for instance, the IP address of [www.zyxel.com](http://www.zyxel.com) is 204.217.0.2. The DNS server is extremely important because without it, you must know the IP address of a computer before you can access it.

The Zyxel Device can get the DNS server addresses in the following ways.

- 1 The ISP tells you the DNS server addresses, usually in the form of an information sheet, when you sign up. If your ISP gives you DNS server addresses, manually enter them in the DNS server fields.
- 2 If your ISP dynamically assigns the DNS server IP addresses (along with the Zyxel Device's WAN IP address), set the DNS server fields to get the DNS server address from the ISP.

## IPv6 Addressing

The 128-bit IPv6 address is written as eight 16-bit hexadecimal blocks separated by colons (:). This is an example IPv6 address `2001:0db8:1a2b:0015:0000:0000:1a2f:0000`.

IPv6 addresses can be abbreviated in two ways:

- Leading zeros in a block can be omitted. So `2001:0db8:1a2b:0015:0000:0000:1a2f:0000` can be written as `2001:db8:1a2b:15:0:0:1a2f:0`.

- Any number of consecutive blocks of zeros can be replaced by a double colon. A double colon can only appear once in an IPv6 address. So 2001:0db8:0000:0000:1a2f:0000:0000:0015 can be written as 2001:0db8::1a2f:0000:0000:0015, 2001:0db8:0000:0000:1a2f::0015, 2001:db8::1a2f:0:0:15 or 2001:db8:0:0:1a2f::15.

## IPv6 Prefix and Prefix Length

Similar to an IPv4 subnet mask, IPv6 uses an address prefix to represent the network address. An IPv6 prefix length specifies how many most significant bits (start from the left) in the address compose the network address. The prefix length is written as "/x" where x is a number. For example,

```
2001:db8:1a2b:15::1a2f:0/32
```

means that the first 32 bits (2001:db8) is the subnet prefix.

# CHAPTER 9

## Wireless

### 9.1 Wireless Overview

This chapter describes the Zyxel Device's **Network Setting > Wireless** screens. Use these screens to set up your Zyxel Device's WiFi network and security settings.

#### 9.1.1 What You Can Do in this Chapter

This section describes the Zyxel Device's **Wireless** screens. Use these screens to set up your Zyxel Device's WiFi connection.

- Use the **General** screen to enable the Wireless LAN, enter the SSID and select the WiFi security mode ([Section 9.2 on page 239](#)).
- Use the **Guest/More AP** screen to set up multiple WiFi networks on your Zyxel Device ([Section 9.3 on page 245](#)).
- Use the **MAC Authentication** screen to allow or deny WiFi clients based on their MAC addresses from connecting to the Zyxel Device ([Section 9.4 on page 249](#)).
- Use the **WPS** screen to enable or disable WPS, view or generate a security PIN (Personal Identification Number) ([Section 9.5 on page 250](#)).
- Use the **WMM** screen to enable WiFi MultiMedia (WMM) to ensure quality of service in WiFi networks for multimedia applications ([Section 9.6 on page 252](#)).
- Use the **Others** screen to configure WiFi advanced features, such as the RTS/CTS Threshold ([Section 9.7 on page 254](#)).
- Use the **Channel Status** screen to scan the number of accessing points and view the results ([Section 9.8 on page 227](#)).
- Use the **MESH** screen to enable or disable MPro Mesh on your Zyxel Device ([Section 9.9 on page 258](#)).

#### 9.1.2 What You Need to Know

##### Wireless Basics

“Wireless” is essentially radio communication. In the same way that walkie-talkie radios send and receive information over the airwaves, wireless networking devices exchange information with one another. A wireless networking device is just like a radio that lets your computer exchange information with radios attached to other computers. Like walkie-talkies, most wireless networking devices operate at radio frequency bands that are open to the public and do not require a license to use. However, wireless networking is different from that of most traditional radio communications in that there are a number of wireless networking standards available with different methods of data encryption.

## WiFi6 / IEEE 802.11ax

WiFi6 is backwards compatible with IEEE 802.11a/b/g/n/ac and is most suitable in areas with a high concentration of users. WiFi6 devices support Target Wakeup Time (TWT) allowing them to automatically power down when they are inactive.

The following table displays the comparison of the different WiFi standards.

Table 54 WiFi Standards Comparison

WIFI STANDARD	MAXIMUM LINK RATE *	BAND	SIMULTANEOUS CONNECTIONS
802.11b	11 Mbps	2.4 GHz	1
802.11a/g	54 Mbps	2.4 GHz and 5 GHz	1
802.11n	600 Mbps	2.4 GHz and 5 GHz	1
802.11ac	6.93 Gbps	5 GHz	4
802.11ax	2.4 Gbps	2.4 GHz	128
	9.61 Gbps	5 GHz and 6 GHz	

\* The maximum link rate is for reference under ideal conditions only.

## WiFi 6E (IEEE802.11ax - Extended Standard)

WiFi 6E is an extended standard of WiFi 6 (IEEE 802.11ax). WiFi 6E inherits all the WiFi 6 features and brings with an additional 6 GHz band. The 6 GHz band allows you to avoid possible congested traffic in the lower 2.4 GHz and 5 GHz bands. WiFi clients must support WiFi 6E to connect to the device using the 6 GHz band.

You must use WPA3 for security with WiFi 6E.

Note: Check your client device's product specification to see if your client device supports the 6 GHz band (WiFi 6E). If not, you should still use the 2.4/5 GHz bands for connection.

## Finding Out More

See [Section 9.10 on page 259](#) for advanced technical information on WiFi networks.

## 9.2 Wireless General Settings

Use this screen to enable the WiFi, enter the SSID and select the WiFi security mode. We recommend that you select **More Secure** to enable **WPA3-SAE** data encryption.

Note: If you are configuring the Zyxel Device from a computer connected by WiFi and you change the Zyxel Device's SSID, channel or security settings, you will lose your WiFi connection when you press **Apply**. You must change the WiFi settings of your computer to match the new settings on the Zyxel Device.

Note: If upstream or downstream bandwidth is empty, the Zyxel Device sets the value automatically.

Note: Setting a maximum upstream or downstream bandwidth will significantly decrease wireless performance.

Note: **Keep the same settings for 2.4G, 5G and 6G wireless networks** is enabled and cannot be disabled when you enable **MPro Mesh** in the **Network > Wireless > MESH** screen.


Click **Network Setting > Wireless** to open the **General** screen.



Figure 107 Network Setting &gt; Wireless &gt; General

Use this screen to enable the Wireless LAN, enter the SSID and select the wireless security mode. We recommend that you select **More Secure** to enable **WPA2-PSK/WPA3-SAE/OWE** data encryption.

### Wireless

Wireless  Keep the same settings for 2.4G, 5G and 6G wireless networks 

### Wireless Network Setup

Band

Wireless

Channel  Current: 6 / 20 MHz


Bandwidth

Control Sideband

### Wireless Network Settings

Wireless Network Name

Max Clients

Hide SSID 

Blocking BSSID LAN Access

Multicast Forwarding

Max. Upstream Bandwidth  Kbps

Max. Downstream Bandwidth  Kbps

**Note**

(1) If you are configuring the Zyxel Device from a computer connected by WiFi and you change the Zyxel Device's SSID, channel or security settings, you will lose your WiFi connection when you press **Apply**. You must change the WiFi settings of your computer to match the new settings on the Zyxel Device.

(2) If upstream/downstream bandwidth is empty, the Zyxel Device sets the value automatically. Setting a maximum upstream/downstream bandwidth will significantly decrease wireless performance.

BSSID

### Security Level


No Security More Secure (Recommended)

**More Secure (Recommended)**


Security Mode

Generate password automatically

Enter 8-63 ASCII characters or 64 hexadecimal digits ("0-9", "A-F").

Password  

Strength



The following table describes the general WiFi labels in this screen.

Table 55 Network Setting > Wireless > General

LABEL	DESCRIPTION
Wireless	
Wireless	Select <b>Keep the same settings for 2.4G, 5G and 6G wireless networks</b> and the 2.4 GHz, 5 GHz and 6 GHz WiFi networks will use the same SSID and wireless security settings.
Wireless/WiFi Network Setup	
Band	This shows the WiFi band which this radio profile is using. <b>2.4GHz</b> is the frequency used by IEEE 802.11b/g/n/ax WiFi clients, <b>5GHz</b> is used by IEEE 802.11a/n/ac/ax WiFi clients while <b>6GHz</b> is used by IEEE 802.11a/n/ac/ax WiFi clients.
Wireless/WiFi	Click this switch to enable or disable WiFi in this field. When the switch turns blue, the function is enabled. Otherwise, it is not.
Channel	Select a channel from the drop-down list box. The options vary depending on the frequency band and the country you are in.  Use <b>Auto</b> to have the Zyxel Device automatically determine a channel to use.
Bandwidth	A standard 20 MHz channel offers transfer speeds of up to 150 Mbps whereas a 40 MHz channel uses two standard channels and offers speeds of up to 300 Mbps.  40 MHz (channel bonding or dual channel) bonds two adjacent radio channels to increase throughput. The WiFi clients must also support 40 MHz. It is often better to use the 20 MHz setting in a location where the environment hinders the WiFi signal.  An 80 MHz channel groups adjacent 40 MHz channels into pairs to increase bandwidth even higher.  Select <b>20MHz</b> if you want to lessen radio interference with other wireless devices in your neighborhood or the WiFi clients do not support channel bonding.  Because not all devices support 40 MHz and/or 160 MHz channels, select <b>20/40MHz</b> or <b>20/40/80/160MHz</b> to allow the Zyxel Device to adjust the channel bandwidth automatically.
Control Sideband	This is available for some regions when you select a specific channel and set the <b>Bandwidth</b> field to <b>40MHz</b> or <b>20/40MHz</b> . Set whether the control channel (set in the <b>Channel</b> field) should be in the <b>Lower</b> or <b>Upper</b> range of channel bands.
Wireless/WiFi Network Settings	
Wireless/WiFi Network Name	The SSID (Service Set IDentity) identifies the service set with which a wireless device is associated. Wireless devices associating to the access point (AP) must have the same SSID.  Enter a descriptive name for this WiFi network. You can use up to 32 printable characters, including spaces.
Max Clients	Specify the maximum number of clients that can connect to this network at the same time.
Hide SSID	Select this check box to hide the SSID in the outgoing beacon frame so a station cannot obtain the SSID through scanning using a site survey tool.  This check box is grayed out if the WPS function is enabled in the <b>Network Setting &gt; Wireless &gt; WPS</b> screen.
Blocking BSSID LAN Access	Select this check box so that the WiFi client's access to all devices on the LAN will be blocked.
Multicast Forwarding	Select this check box to allow the Zyxel Device to convert wireless multicast traffic into wireless unicast traffic.
Max. Upstream Bandwidth	Max. Upstream Bandwidth allows you to specify the maximum rate for upstream wireless traffic to the WAN from this wireless LAN in kilobits per second (Kbps).
Max. Downstream Bandwidth	Max. Upstream Bandwidth allows you to specify the maximum rate for downstream wireless traffic to this wireless LAN from the WAN in kilobits per second (Kbps).
BSSID	This shows the MAC address of the wireless interface on the Zyxel Device when WiFi is enabled.

Table 55 Network Setting &gt; Wireless &gt; General (continued)

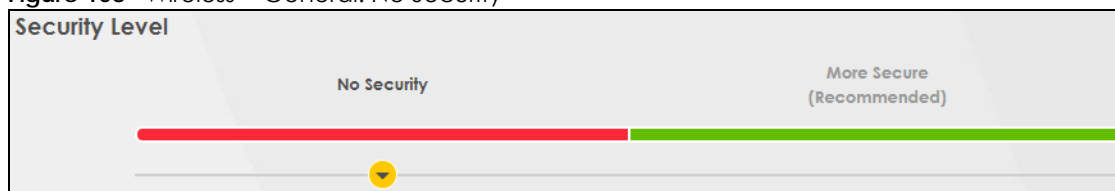
LABEL	DESCRIPTION
Security Level	
Security Mode	Select <b>More Secure (Recommended)</b> to add security on this WiFi network. The WiFi clients which want to associate to this network must have same WiFi security settings as the Zyxel Device. When you select to use a security, additional options appears in this screen.  Or you can select <b>No Security</b> to allow any client to associate this network without any data encryption or authentication.  See the following sections for more details about this field.
Cancel	Click <b>Cancel</b> to restore your previously saved settings.
Apply	Click <b>Apply</b> to save your changes.

## 9.2.1 No Security

Select **No Security** to allow wireless stations to communicate with the access points without any data encryption or authentication.

Note: If you do not enable any WiFi security on your Zyxel Device, your network is accessible to any wireless networking device that is within range.

Figure 108 Wireless &gt; General: No Security



The following table describes the labels in this screen.

Table 56 Wireless &gt; General: No Security

LABEL	DESCRIPTION
Security Level	Choose <b>No Security</b> to allow all WiFi connections without data encryption or authentication.

## 9.2.2 More Secure (Recommended)

The WPA-PSK (WiFi Protected Access-Pre-Shared Key) security mode provides both improved data encryption and user authentication over WEP. Using a pre-shared key, both the Zyxel Device and the connecting client share a common password in order to validate the connection. This type of encryption, while robust, is not as strong as WPA, WPA2 or even WPA2-PSK. The WPA2-PSK security mode is a more robust version of the WPA encryption standard. It offers better security, although the use of PSK makes it less robust than it could be.

The WPA3-SAE (Simultaneous Authentication of Equals handshake) security mode protects against dictionary attacks (password guessing attempts). It improves security by requiring a new encryption key every time a WPA3 connection is made. A handshake is the communication between the Zyxel Device and a connecting client at the beginning of a WiFi session.

Click **Network Setting > Wireless** to display the **General** screen. Select **More Secure** as the security level. Then select **WPA3-SAE** from the **Security Mode** list if your WiFi client supports it. If you are not sure, select **WPA3-SAE/WPA2-PSK** or **WPA2-PSK**.

**Figure 109** Wireless > General: More Secure: WPA3-SAE/WPA2-PSK

The following table describes the labels in this screen.

**Table 57** Wireless > General: More Secure: WPA3-SAE/WPA2-PSK




LABEL	DESCRIPTION
Security Level	Select <b>More Secure</b> to enable data encryption.
Security Mode	Select a security mode from the drop-down list box.
Generate password automatically	Select this option to have the Zyxel Device automatically generate a password. The password field will not be configurable when you select this option.
Password	Select <b>Generate password automatically</b> or enter a <b>Password</b> . The password has two uses. <ol style="list-style-type: none"> <li>Manual. Manually enter the same password on the Zyxel Device and the client. You can use 8 – 63 alphanumeric (0-9, a-z, A-Z) and special characters, including spaces.</li> <li>WPS. When using WPS, the Zyxel Device sends this password to the client.</li> </ol> <p>Note: More than 63 hexadecimal characters are not accepted for WPS.</p> <p>Click the Eye icon to show or hide the password for your wireless network. When the Eye icon is slashed , you'll see the password in plain text. Otherwise, it is hidden.</p>
Strength	This displays the current password strength – <b>weak</b> , <b>medium</b> , <b>strong</b> .
Click this  to show more fields in this section. Click this  to hide them.	

Table 57 Wireless &gt; General: More Secure: WPA3-SAE/WPA2-PSK (continued)

LABEL	DESCRIPTION
Encryption	<p><b>AES</b> is the default data encryption type, which uses a 128-bit key.</p> <p>Select the encryption type (<b>AES</b> or <b>TKIP+AES</b>) for data encryption.</p> <p>Select <b>AES</b> if your WiFi clients can all use AES.</p> <p>Select <b>TKIP+AES</b> to allow the WiFi clients to use either TKIP or AES.</p> <p>Note: Not all models support <b>TKIP+AES</b> encryption.</p>
Timer	This is the rate at which the RADIUS server sends a new group key out to all clients.

## 9.3 Guest/More AP Screen

Use this screen to configure a guest WiFi network that allows access to the Internet through the Zyxel Device. You can use one access point to provide several BSSs simultaneously. You can then assign varying security types to different SSIDs. WiFi clients can use different SSIDs to associate with the same access point.

Click **Network Setting > Wireless > Guest/More AP**.

The following table introduces the supported WiFi networks.

Table 58 Supported WiFi Networks

WIFI NETWORKS	WHERE TO CONFIGURE
Main/1	Network Setting > Wireless > General screen
Guest/3	Network Setting > Wireless > Guest/More AP screen

The following screen displays.

Figure 110 Network Setting &gt; Wireless &gt; Guest/More AP

This screen allows you to configure a guest wireless network that allows access to the Internet only through the Zyxel Device. You can also configure additional wireless networks, each with different security settings, in this screen.

Band: 2.4GHz

#	Status	SSID	Security	Guest WLAN	Modify
1	🟡	Zyxel_B2BB_guest1	WPA3-Personal-Transition	External Guest	✎
2	🟡	Zyxel_B2BB_guest2	WPA3-Personal-Transition	External Guest	✎
3	🟡	Zyxel_B2BB_guest3	WPA3-Personal-Transition	External Guest	✎

The following table describes the labels in this screen.

Table 59 Network Setting &gt; Wireless &gt; Guest/More AP

LABEL	DESCRIPTION
Band	Select a <b>2.4GHz</b> or <b>5GHz</b> frequency band to display the SSID profile of the selected band.
#	This is the index number of the entry.
Status	This field indicates whether this SSID is active. A yellow bulb signifies that this SSID is active, while a gray bulb signifies that this SSID is not active.

Table 59 Network Setting &gt; Wireless &gt; Guest/More AP (continued)

LABEL	DESCRIPTION
SSID	<p>An SSID profile is the set of parameters relating to one of the Zyxel Device's BSSs. The SSID (Service Set Identifier) identifies the Service Set with which a wireless device is associated.</p> <p>This field displays the name of the wireless profile on the network. When a WiFi client scans for an AP to associate with, this is the name that is broadcast and seen in the WiFi client utility.</p> <p>Note: The SSID profiles displayed differ by the frequency band you select in the <b>Band</b> field.</p>
Security	This field indicates the security mode of the SSID profile.
Guest WLAN	<p>This displays if the guest WLAN function has been enabled for this WLAN.</p> <p>If <b>Home Guest</b> displays, clients can connect to each other directly.</p> <p>If <b>External Guest</b> displays, clients are blocked from connecting to each other directly.</p> <p><b>N/A</b> displays if guest WLAN is disabled.</p>
Modify	Click the <b>Edit</b> icon of an SSID profile to configure the SSID profile.

### 9.3.1 The Edit Guest/More AP Screen

Use this screen to create Guest and additional WiFi networks with different security settings.

Note: If upstream/downstream bandwidth is empty, the Zyxel Device sets the value automatically. Setting a maximum upstream/downstream bandwidth will significantly decrease WiFi performance.

Click the **Edit** icon next to an SSID in the **Guest/More AP** screen. The following screen displays.

Figure 111 Network Setting > Wireless > Guest/More AP > Edit

The following table describes the fields in this screen.

Table 60 Network Setting > Wireless > Guest/More AP > Edit


LABEL	DESCRIPTION
WiFi/Wireless Network Setup	
WiFi/Wireless	Click this switch to enable or disable the WiFi in this field. When the switch turns blue  , the function is enabled; otherwise, it is not.
WiFi/Wireless Network Settings	
WiFi/Wireless Network Name	The SSID (Service Set IDentity) identifies the service set with which a wireless device is associated. Wireless devices associating to the access point (AP) must have the same SSID.  Enter a descriptive name for the WiFi. You can use up to 32 printable characters, including spaces.

Table 60 Network Setting &gt; Wireless &gt; Guest/More AP &gt; Edit (continued)



LABEL	DESCRIPTION
Hide SSID	Select this check box to hide the SSID in the outgoing beacon frame so a station cannot obtain the SSID through scanning using a site survey tool.
Guest WLAN	Select this to create Guest WLANs for home and external clients. Select the WLAN type in the <b>Access Scenario</b> field.
Access Scenario	If you select <b>Home Guest</b> , clients can connect to each other directly. If you select <b>External Guest</b> , clients are blocked from connecting to each other directly.
Max. Upstream Bandwidth	Specify the maximum rate for upstream wireless traffic to the WAN from this WLAN in kilobits per second (Kbps).
Max. Downstream Bandwidth	Specify the maximum rate for downstream wireless traffic to this WLAN from the WAN in kilobits per second (Kbps).
BSSID	This shows the MAC address of the WiFi interface on the Zyxel Device when WiFi is enabled.
SSID Subnet	Click on this switch to <b>Enable</b> this function if you want the wireless network interface to assign DHCP IP addresses to the associated WiFi clients.  This option cannot be used if <b>Keep 2.4G and 5G wireless network name the same</b> is enabled in <b>Network &gt; Wireless &gt; General</b> .
DHCP Start Address	Specify the first of the contiguous addresses in the DHCP IP address pool.  The Zyxel Device assigns IP addresses from this DHCP pool to WiFi clients connecting to the SSID.
DHCP End Address	Specify the last of the contiguous addresses in the DHCP IP address pool.
SSID Subnet Mask	Specify the subnet mask of the Zyxel Device for the SSID subnet.
LAN IP Address	Specify the IP address of the Zyxel Device for the SSID subnet.
Security Level	
Security Mode	Select <b>More Secure (Recommended)</b> to add security on this WiFi network. The WiFi clients which want to associate to this network must have the same WiFi security settings as the Zyxel Device. After you select to use a security, additional options appears in this screen.  Or you can select <b>No Security</b> to allow any client to associate this network without any data encryption or authentication.  See <a href="#">Section 9.2.1 on page 243</a> for more details about this field.
Generate password automatically	Select this option to have the Zyxel Device automatically generate a password. The password field will not be configurable when you select this option.
Password	WPA2-PSK uses a simple common password, instead of user-specific credentials.  If you did not select <b>Generate password automatically</b> , you can manually enter a pre-shared key from 8 to 63 alphanumeric (0-9, a-z, A-Z) and special characters. Spaces are allowed.  Click the Eye icon to show or hide the password of your WiFi network. When the Eye icon is slashed  , you'll see the password in plain text. Otherwise, it's hidden.
Strength	This displays the current password strength – <b>weak, medium, strong</b> .
Click this  to show more fields in this section. Click again to hide them.	
Encryption	Select the encryption type ( <b>AES</b> or <b>TKIP+AES</b> ) for data encryption.  Select <b>AES</b> if your WiFi clients can all use AES.  Select <b>TKIP+AES</b> to allow the WiFi clients to use either TKIP or AES.  Not all models support the <b>TKIP+AES</b> option.
Timer	The <b>Timer</b> is the rate at which the RADIUS server sends a new group key out to all clients.



Table 60 Network Setting &gt; Wireless &gt; Guest/More AP &gt; Edit (continued)

LABEL	DESCRIPTION
Cancel	Click <b>Cancel</b> to exit this screen without saving.
OK	Click <b>OK</b> to save your changes.

## 9.4 MAC Authentication

Use this screen to give exclusive access to specific connected devices (**Allow**) or exclude specific devices from accessing the Zyxel Device (**Deny**), based on the MAC address of each connected device. Every Ethernet device has a unique factory-assigned MAC (Media Access Control) address, which consists of six pairs of hexadecimal characters, for example: 00:A0:C5:00:00:02. You need to know the MAC addresses of the connected device you want to allow/deny to configure this screen.

Note: Note: You can have up to 25 MAC authentication rules. This screen is not available when MPro Mesh is enabled in the **Network Setting > Wireless > MESH** screen.

Use this screen to view your Zyxel Device's MAC filter settings and add new MAC filter rules. Click **Network Setting > Wireless > MAC Authentication**. The screen appears as shown.

Figure 112 Network Setting &gt; Wireless &gt; MAC Authentication

MAC Authentication can allow or block the access of the device(s) to your wireless network. Edit the list in the table to decide the rule of the access on device(s)

**General**

Band  2.4GHz  5GHz

SSID

MAC Restrict Mode  Disable  Deny  Allow

**MAC address List**

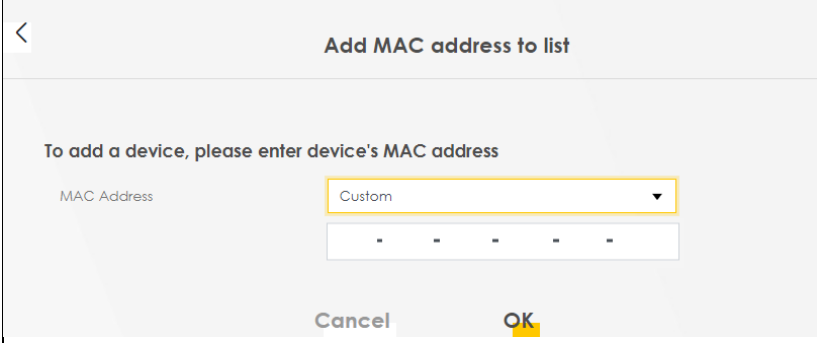
#	MAC Address	Modify
---	-------------	--------

The following table describes the labels in this screen.

Table 61 Network Setting &gt; Wireless &gt; MAC Authentication

LABEL	DESCRIPTION
General	
Band	Select a <b>2.4GHz</b> or <b>5GHz</b> frequency band to display associated WiFi devices in the selected band, identified by MAC address.
SSID	Select the SSID for which you want to configure MAC filter settings.

Table 61 Network Setting &gt; Wireless &gt; MAC Authentication (continued)

LABEL	DESCRIPTION
MAC Restrict Mode	<p>Define the filter action for the list of MAC addresses in the <b>MAC Address</b> table.</p> <p>Select <b>Disable</b> to turn off MAC filtering.</p> <p>Select <b>Deny</b> to block access to the Zyxel Device. MAC addresses not listed will be allowed to access the Zyxel Device.</p> <p>Select <b>Allow</b> to permit access to the Zyxel Device. MAC addresses not listed will be denied access to the Zyxel Device.</p>
MAC address List	
Add new MAC address	<p>This field is available when you select <b>Deny</b> or <b>Allow</b> in the <b>MAC Restrict Mode</b> field.</p> <p>Click this if you want to add a new MAC address entry to the MAC filter list below.</p> <p>Select an existing WiFi client from the list to add as a new entry. Select <b>Custom</b> if you want to manually enter the <b>Host Name</b> and <b>MAC Address</b>.</p> <p>Enter the MAC addresses of the WiFi devices that are allowed or denied access to the Zyxel Device in these address fields. Enter the MAC addresses in a valid MAC address format, that is, six hexadecimal character pairs, for example, 12:34:56:78:9a:bc.</p> 
#	This is the index number of the entry.
MAC Address	This is the MAC addresses of the WiFi devices that are allowed or denied access to the Zyxel Device.
Modify	<p>Click the <b>Edit</b> icon and type the MAC address of the peer device in a valid MAC address format (six hexadecimal character pairs, for example 12:34:56:78:9a:bc).</p> <p>Click the <b>Delete</b> icon to delete the entry.</p>
Cancel	Click <b>Cancel</b> to exit this screen without saving.
Apply	Click <b>Apply</b> to save your changes.

## 9.5 WPS

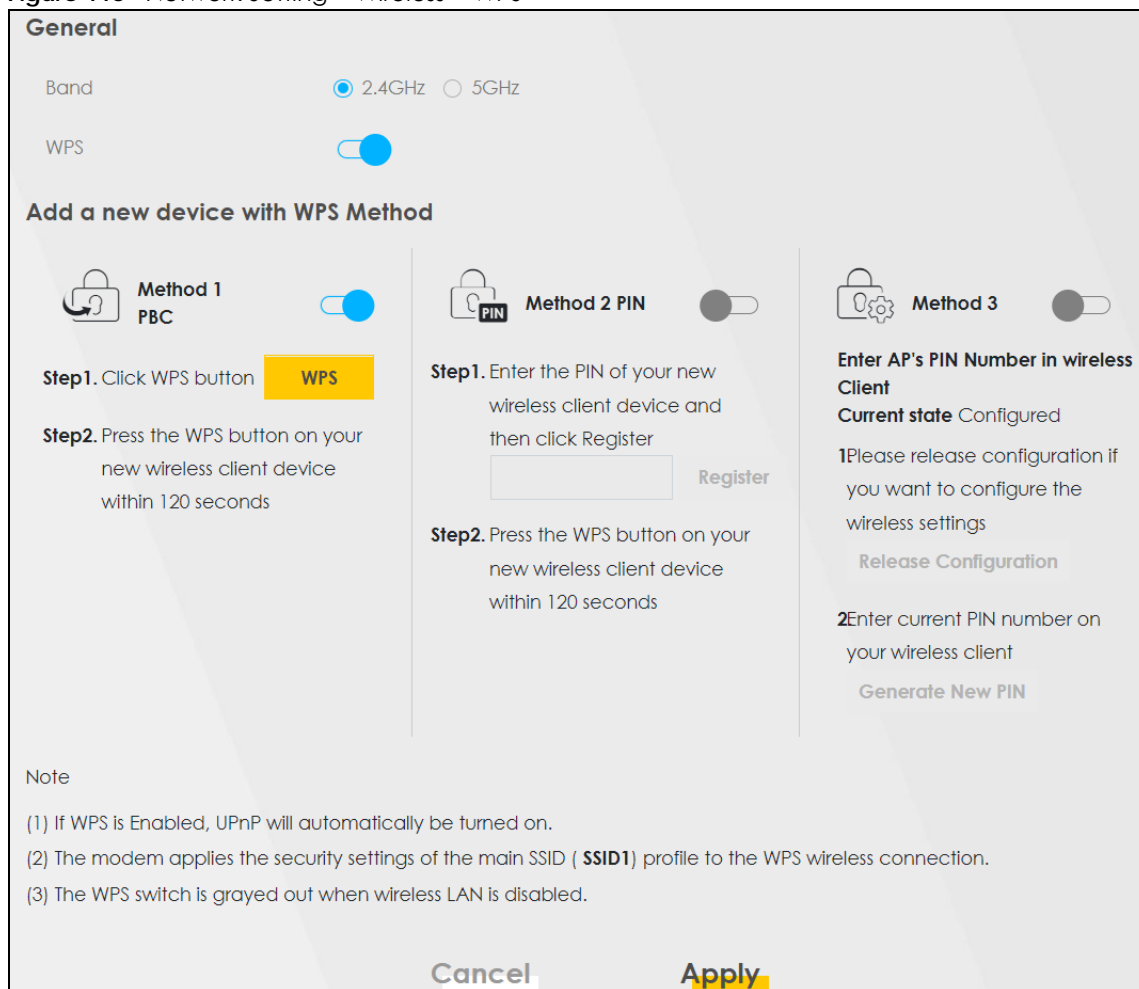
Use this screen to configure WiFi Protected Setup (WPS) on your Zyxel Device.

WiFi Protected Setup (WPS) allows you to quickly set up a WiFi network with strong security, without having to configure security settings manually. Select one of the WPS methods and follow the instructions to establish a WPS connection. Your WiFi devices must support WPS to use this feature. We recommend using Push Button Configuration (**PBC**) if your WiFi device supports it. See [Section 9.10.8.1 on page 265](#) for more information about WPS.

Note: The WPS switch is unavailable if the WiFi is disabled.  
 If WPS is enabled, UPnP will automatically be turned on.

Click **Network Setting > Wireless > WPS**. The following screen displays. Click this switch and it will turn blue. Click **Apply** to activate the WPS function. Then you can configure the WPS settings in this screen.

**Figure 113** Network Setting > Wireless > WPS



The following table describes the labels in this screen.

**Table 62** Network Setting > Wireless > WPS

LABEL	DESCRIPTION
General	
Band	Select a <b>2.4GHz</b> and <b>5GHz</b> frequency band to enable WPS for all WiFi networks in the selected band.  If you use the WPS button on the Zyxel Device ports panel, WPS is automatically enabled on both 2.4GHz and 5GHz bands. See <a href="#">Section 2.3 on page 50</a> for more information about the WPS button.
WPS	Slide this to the right to enable and have the Zyxel Device activate WPS. Otherwise, it is disabled.
Add a new device with WPS Method	

Table 62 Network Setting &gt; Wireless &gt; WPS (continued)

LABEL	DESCRIPTION
Method 1 PBC	Use this section to set up a WPS WiFi network using Push Button Configuration (PBC). Click this switch to make it turn blue. Click <b>Apply</b> to activate WPS method 1 on the Zyxel Device.
WPS	Click this button to add another WPS-enabled WiFi device (within WiFi range of the Zyxel Device) to your WiFi network. This button may either be a physical button on the outside of a WiFi device, or a menu button similar to the <b>WPS button</b> on this screen.  Note: You must press the other WiFi device's WPS button within 2 minutes of pressing this button.
Method 2 PIN	Use this section to set up a WPS WiFi network by entering the PIN of the client into the Zyxel Device. Click this switch to make it turn blue. Click <b>Apply</b> to activate WPS method 2 on the Zyxel Device.
Register	Enter the PIN of the WiFi device that you are setting up a WPS connection with and click <b>Register</b> to authenticate and add the WiFi device to your WiFi network.  You can find the PIN either on the outside of the WiFi device, or by checking the WiFi device's settings.  Note: You must also activate WPS on that WiFi device within 2 minutes to have it present its PIN to the Zyxel Device.
Method 3	Use this section to set up a WPS WiFi network by entering the PIN of the Zyxel Device into the client. Click this switch to make it turn blue. Click <b>Apply</b> to activate WPS method 3 on the Zyxel Device.
Release Configuration	The default WPS status is <b>configured</b> .  Click this button to remove all configured WiFi and WiFi security settings for WPS connections on the Zyxel Device.
Generate New PIN	If this method has been enabled, the PIN (Personal Identification Number) of the Zyxel Device is shown here. Enter this PIN in the configuration utility of the WiFi device you want to connect to using WPS.  The PIN is not necessary when you use the WPS push-button method.  Click the <b>Generate New PIN</b> button to have the Zyxel Device create a new PIN.
Cancel	Click <b>Cancel</b> to restore your previously saved settings.
Apply	Click <b>Apply</b> to save your changes.

## 9.6 WMM

Use this screen to enable WiFi MultiMedia (WMM) and WMM Automatic Power Save Delivery (APSD) in WiFi networks for multimedia applications. WMM enhances data transmission quality, while APSD improves power management of WiFi clients. This allows time-sensitive applications, such as voice and videos, to run more smoothly.

Click **Network Setting > Wireless > WMM** to display the following screen.

**Figure 114** Network Setting > Wireless > WMM

Use this screen to enable Wi-Fi MultiMedia (WMM) and WMM Automatic Power Save (APSD) in wireless networks for multimedia applications. WMM enhances data transmission quality, while APSD improves power management of wireless clients. This allows delay-sensitive applications, such as voice and video, to run more smoothly.

Band

WMM of SSID1

WMM of SSID2

WMM of SSID3

WMM of SSID4

WMM Automatic Power Save Delivery (APSD)

Note

(1) WMM cannot be disabled if 802.11 mode includes 802.11n or 802.11ac.

Note: WMM cannot be disabled if 802.11 mode includes 802.11n or 802.11ac.

Note: APSD only affects SSID1. For SSID2-SSID4, APSD is always enabled.

Note: This screen is not available when MPro Mesh is enabled in the **Network Setting > Wireless > MESH** screen.

The following table describes the labels in this screen.

Table 63 Network Setting &gt; Wireless &gt; WMM

LABEL	DESCRIPTION
Band	Select a <b>2.4GHz</b> and <b>5GHz</b> frequency band to enable or disable the <b>WMM of SSID</b> of the selected band.
WMM of SSID	Select <b>On</b> to have the Zyxel Device automatically give the WiFi network (SSIDx) a priority level according to the ToS value in the IP header of packets it sends. WMM QoS (WiFi MultiMedia Quality of Service) gives high priority to video, which makes them run more smoothly.  SSID1 is the <b>General</b> WiFi SSID; SSID2-SSID4 are the <b>Guest</b> WiFi SSIDs.  If the <b>802.11 Mode</b> in <b>Network Setting &gt; Wireless &gt; Others</b> is set to include 802.11n or 802.11ac, WMM cannot be disabled.
WMM Automatic Power Save Delivery (APSD)	Select this option to extend the battery life of your mobile devices (especially useful for small devices that are running multimedia applications). The Zyxel Device goes to sleep mode to save power when it is not transmitting data. The AP buffers the packets sent to the Zyxel Device until the Zyxel Device "wakes up." The Zyxel Device wakes up periodically to check for incoming data.  Note: This works only if the WiFi device to which the Zyxel Device is connected also supports this feature.
Cancel	Click <b>Cancel</b> to restore your previously saved settings.
Apply	Click <b>Apply</b> to save your changes.

## 9.7 Others Screen

Use this screen to configure advanced WiFi settings, such as additional security settings, power saving, and data transmission settings. Click **Network Setting > Wireless > Others**. The screen appears as shown.

Note: This screen is not available when MPro Mesh is enabled in the **Network Setting > Wireless > MESH** screen.

See [Section 9.10.2 on page 261](#) for detailed definitions of the terms listed here.

**Figure 115** Network Setting > Wireless > Others

Use this screen to configure advanced wireless settings, such as additional security settings, power saving, and data transmission settings.

Band  2.4GHz  5GHz

RTS/CTS Threshold

Fragmentation Threshold

Output Power  ▼

Beacon Interval  ms

DTIM Interval  ms

802.11 Mode  ▼

802.11 Protection  ▼

Preamble

Protected Management Frames

The following table describes the labels in this screen.

**Table 64** Network Setting > Wireless > Others

LABEL	DESCRIPTION
Band	Select a <b>2.4GHz</b> or <b>5GHz</b> frequency band to display the following wireless settings for the selected band.
RTS/CTS Threshold	Data with its frame size larger than this value will perform the RTS (Request To Send)/CTS (Clear To Send) handshake. Enter a value between 0 and 2347.
Fragmentation Threshold	This is the maximum data fragment size that can be sent. Enter a value between 256 and 2346.
Output Power	Set the output power of the Zyxel Device. If there is a high density of APs in an area, decrease the output power to reduce interference with other APs. Select one of the following: <b>20%</b> , <b>40%</b> , <b>60%</b> , <b>80%</b> or <b>100%</b> .

Table 64 Network Setting &gt; Wireless &gt; Others (continued)

LABEL	DESCRIPTION
Beacon Interval	<p>When a wirelessly networked device sends a beacon, it includes with it a beacon interval. This specifies the time period before the device sends the beacon again.</p> <p>The interval tells receiving devices on the network how long they can wait in low power mode before waking up to handle the beacon. This value can be set from 50 ms to 1000 ms. A high value helps save current consumption of the access point.</p>
DTIM Interval	<p>Delivery Traffic Indication Message (DTIM) is the time period after which broadcast and multicast packets are transmitted to mobile clients in the Power Saving mode. A high DTIM value can cause clients to lose connectivity with the network. This value can be set from 1 to 255.</p>
802.11 Mode	<p>For 2.4 GHz frequency WiFi devices:</p> <ul style="list-style-type: none"> <li>• Select <b>802.11b Only</b> to allow only IEEE 802.11b compliant WiFi devices to associate with the Zyxel Device.</li> <li>• Select <b>802.11g Only</b> to allow only IEEE 802.11g compliant WiFi devices to associate with the Zyxel Device.</li> <li>• Select <b>802.11n Only</b> to allow only IEEE 802.11n compliant WiFi devices to associate with the Zyxel Device.</li> <li>• Select <b>802.11b/g Mixed</b> to allow either IEEE 802.11b or IEEE 802.11g compliant WiFi devices to associate with the Zyxel Device. The transmission rate of your Zyxel Device might be reduced.</li> <li>• Select <b>802.11b/g/n Mixed</b> to allow IEEE 802.11b, IEEE 802.11g or IEEE 802.11n compliant WiFi devices to associate with the Zyxel Device. The transmission rate of your Zyxel Device might be reduced.</li> <li>• Select <b>802.11b/g/n/ax Mixed</b> to allow IEEE 802.11b, IEEE 802.11g, IEEE 802.11n or IEEE 802.11ax compliant WiFi devices to associate with the Zyxel Device. The transmission rate of your Zyxel Device might be reduced.</li> </ul> <p>For 5 GHz / 6GHz frequency WiFi devices:</p> <ul style="list-style-type: none"> <li>• Select <b>802.11a Only</b> to allow only IEEE 802.11a compliant WiFi devices to associate with the Zyxel Device.</li> <li>• Select <b>802.11n Only</b> to allow only IEEE 802.11n compliant WiFi devices to associate with the Zyxel Device.</li> <li>• Select <b>802.11ac Only</b> to allow only IEEE 802.11ac compliant WiFi devices to associate with the Zyxel Device.</li> <li>• Select <b>802.11a/n Mixed</b> to allow either IEEE 802.11a or IEEE 802.11n compliant WiFi devices to associate with the Zyxel Device. The transmission rate of your Zyxel Device might be reduced.</li> <li>• Select <b>802.11n/ac Mixed</b> to allow either IEEE 802.11n or IEEE 802.11ac compliant WiFi devices to associate with the Zyxel Device. The transmission rate of your Zyxel Device might be reduced.</li> <li>• Select <b>802.11a/n/ac Mixed</b> to allow IEEE 802.11a, IEEE 802.11n or IEEE 802.11ac compliant WiFi devices to associate with the Zyxel Device. The transmission rate of your Zyxel Device might be reduced.</li> <li>• Select <b>802.11a/n/ac/ax Mixed</b> to allow IEEE 802.11a, IEEE 802.11n, IEEE 802.11ac or IEEE 802.11ax compliant WiFi devices to associate with the Zyxel Device. The transmission rate of your Zyxel Device might be reduced.</li> </ul>
802.11 Protection	<p>Enabling this feature can help prevent collisions in mixed-mode networks (networks with both IEEE 802.11b and IEEE 802.11g traffic).</p> <p>Select <b>Auto</b> to have the wireless devices transmit data after a RTS/CTS handshake. This helps improve IEEE 802.11g performance.</p> <p>Select <b>Off</b> to disable 802.11 protection. The transmission rate of your Zyxel Device might be reduced in a mixed-mode network.</p> <p>This field displays <b>Off</b> and is not configurable when you set <b>802.11 Mode</b> to <b>802.11b Only</b>.</p>
Preamble	<p>Select a preamble type from the drop-down list box. Choices are <b>Long</b> or <b>Short</b>. See <a href="#">Section 9.10.7 on page 264</a> for more information.</p> <p>This field is configurable only when you set 802.11 Mode to <b>802.11b</b>.</p>

Table 64 Network Setting &gt; Wireless &gt; Others (continued)

LABEL	DESCRIPTION
Protected Management Frames	WiFi with Protected Management Frames (PMF) provides protection for unicast and multicast management action frames. Unicast management action frames are protected from both eavesdropping and forging, and multicast management action frames are protected from forging. Select <b>Capable</b> if the WiFi client supports PMF, then the management frames will be encrypted. Select <b>Required</b> to force the WiFi client to support PMF; otherwise the authentication cannot be performed by the Zyxel Device. Otherwise, select <b>Disabled</b> .
Cancel	Click <b>Cancel</b> to restore your previously saved settings.
Apply	Click <b>Apply</b> to save your changes.

## 9.8 Channel Status

Use this screen to scan for WiFi channel noise and view the results. Click **Scan** to start, and then view the results in the **Channel Scan Result** section. The value on each channel number indicates the number of Access Points (AP) using that channel. The Auto-channel-selection algorithm does not always directly follow the AP count; other factors about the channels are also considered. Click **Network Setting > Wireless > Channel Status**. The screen appears as shown.

Note: If the current channel is a DFS channel, the warning 'Channel scan process is denied because current channel is a DFS channel (Channel: 52 – 140). If you want to run channel scan, please select a non-DFS channel and try again.' appears.

Note: The AP count may not be a real-time value.



**Figure 116** Network Setting > Wireless > Channel Status

Use this screen to scan for wireless LAN channel noise and view the results. Click **Scan** to start, and then view the results in the **Channel Scan Result** section. The value on each channel number indicates the number of Access Points (AP) using that channel. The Auto-channel-selection algorithm does not always directly follow the AP count; other factors about the channels are also considered. To switch between 2.4GHz and 5GHz, use the Band-option in the tab 'General'.

### Channel Monitor

#### Wireless Network Setup

Band  2.4GHz  5GHz

Scan wireless LAN Channels **Scan**

Note

(1) It takes about 15 seconds to scan the wireless channels

#### Channel Scan Result

Channel	AP count	Current WLAN Channel
1	15	
2	1	
3	2	
4	1	
5	2	
6	6	
7	1	
8	0	
9	0	
10	2	
11	5	Yes
12	0	
13	0	

Time for last scan: 3 day, 22:38 ago

Note

(1) The value on each channel number indicates the number of Access Points (AP) in that channel.

(2) The Auto-channel-selection algorithm does not always match the AP count, other factors on the channels are also considered.

The following table describes the labels in this screen.

Table 65 Network Setting > Wireless > Channel Status

LABEL	DESCRIPTION
Channel Monitor	
Wireless Network Setup	
Band	Select a <b>2.4GHz</b> or <b>5GHz</b> frequency band on which you want to conduct a channel scan.
Scan WiFi LAN Channels	Click the <b>Scan</b> button to scan WiFi channels.
Channel Scan Result	This displays the results of the channel scan. The blue bar displays the number of access points ( <b>AP count</b> ) in the WiFi channel. The orange bar displays the WiFi channel that the Zyxel Device is now using.

## 9.9 MESH

The Zyxel Device supports MPro Mesh along with the MPro Mesh app to manage your WiFi network. MPro Mesh is the Zyxel implantation of WiFi-Alliance Easy Mesh. It supports AP steering, band steering, auto-configuration and other advances for your WiFi network.

The Zyxel Device can function as a controller to automatically configure WiFi settings on extenders in the network as well as optimize bandwidth usage.

The Zyxel Device optimizes bandwidth usage by directing WiFi clients to an extender (AP steering) or a 2.4GHz/ 5GHz band (band steering) that is less busy.

See [Section 6.1 on page 130](#) for the complete MPro Mesh feature introduction and the following tutorials with the MPro Mesh app.

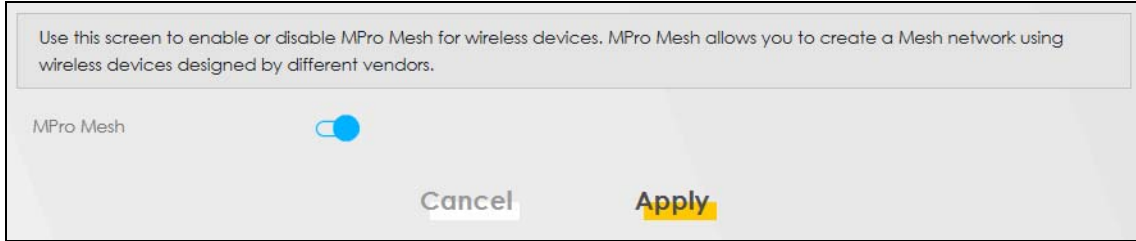
- Setting up your MPro Mesh network with the Zyxel Device and an MPro Mesh extender,
- setting up your general/guest WiFi,
- basic configurations.

### 9.9.1 MPro Mesh

Use this screen to enable or disable MPro Mesh on the Zyxel Device.

Click **Network Setting > Wireless > MESH**. The following screen displays.

Note: When MPro Mesh is enabled, the SSID and WiFi password of the main 2.4 GHz WiFi network will be copied to the main 5 GHz WiFi network.

**Figure 117** Network Setting > Wireless > MESH

The following table describes the labels in this screen.

**Table 66** Network Setting > Wireless > MESH

LABEL	DESCRIPTION
MPro Mesh	Click the button (to the right) to enable the MPro Mesh feature on the Zyxel Device and set up your MPro Mesh network.

## 9.10 Technical Reference

This section discusses WiFi in depth.

### 9.10.1 WiFi Network Overview

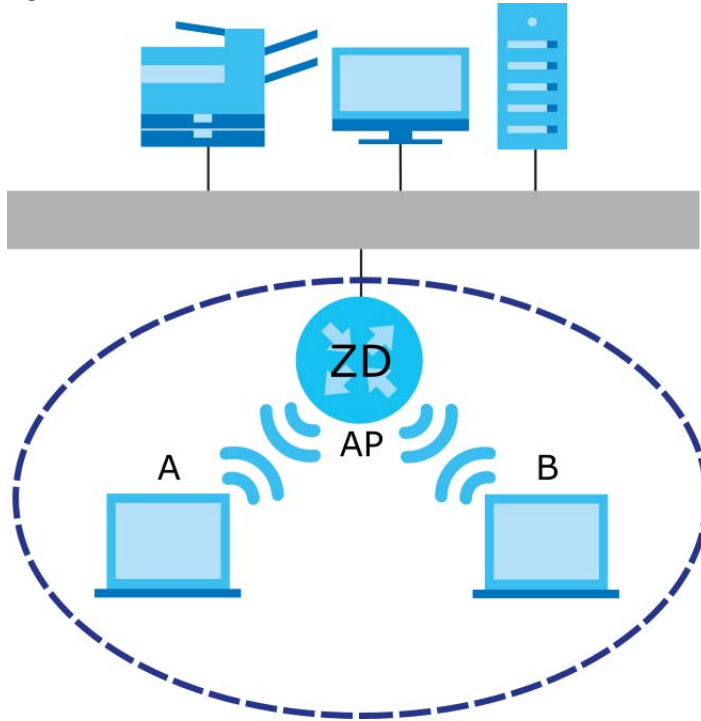
WiFi networks consist of WiFi clients, access points and bridges.

- A WiFi client is a radio connected to a user's computer.
- An access point is a radio with a wired connection to a network, which can connect with numerous WiFi clients and let them access the network.
- A bridge is a radio that relays communications between access points and WiFi clients, extending a network's range.

Normally, a WiFi network operates in an "infrastructure" type of network. An "infrastructure" type of network has one or more access points and one or more WiFi clients. The WiFi clients connect to the access points.

The following figure provides an example of a WiFi network.

Figure 118 Example of a WiFi Network



The WiFi network is the part in the blue circle. In this WiFi network, devices **A** and **B** use the access point (**AP**) to interact with the other devices (such as the printer) or with the Internet. Your Zykel Device is the AP.

Every WiFi network must follow these basic guidelines.

- Every WiFi device in the same WiFi network must use the same SSID.  
The SSID is the name of the WiFi network. It stands for Service Set Identifier.
- If two WiFi networks overlap, they should use a different channel.  
Like radio stations or television channels, each WiFi network uses a specific channel, or frequency, to send and receive information.
- Every WiFi device in the same WiFi network must use security compatible with the AP.  
Security stops unauthorized devices from using the WiFi network. It can also protect the information that is sent in the WiFi network.

## 9.10.2 Additional WiFi Terms

The following table describes some WiFi network terms and acronyms used in the Zyxel Device's Web Configurator.

Table 67 Additional WiFi Terms

TERM	DESCRIPTION
RTS/CTS Threshold	<p>In a WiFi network which covers a large area, WiFi devices are sometimes not aware of each other's presence. This may cause them to send information to the AP at the same time and result in information colliding and not getting through.</p> <p>By setting this value lower than the default value, the WiFi devices must sometimes get permission to send information to the Zyxel Device. The lower the value, the more often the devices must get permission.</p> <p>If this value is greater than the fragmentation threshold value (see below), then WiFi devices never have to get permission to send information to the Zyxel Device.</p>
Preamble	A preamble affects the timing in your WiFi network. There are two preamble modes: long and short. If a WiFi device uses a different preamble mode than the Zyxel Device does, it cannot communicate with the Zyxel Device.
Authentication	The process of verifying whether a WiFi device is allowed to use the WiFi network.
Fragmentation Threshold	A small fragmentation threshold is recommended for busy networks, while a larger threshold provides faster performance if the network is not very busy.

## 9.10.3 WiFi Security Overview

By their nature, radio communications are simple to intercept. For WiFi data networks, this means that anyone within range of a WiFi network without security can not only read the data passing over the airwaves, but also join the network. Once an unauthorized person has access to the network, he or she can steal information or introduce malware (malicious software) intended to compromise the network. For these reasons, a variety of security systems have been developed to ensure that only authorized people can use a WiFi data network, or understand the data carried on it.

These security standards do two things. First, they authenticate. This means that only people presenting the right credentials (often a username and password, or a "key" phrase) can access the network. Second, they encrypt. This means that the information sent over the air is encoded. Only people with the code key can understand the information, and only people who have been authenticated are given the code key.

These security standards vary in effectiveness. Some can be broken, such as the old Wired Equivalent Protocol (WEP). Using WEP is better than using no security at all, but it will not keep a determined attacker out. Other security standards are secure in themselves but can be broken if a user does not use them properly. For example, the WPA-PSK security standard is very secure if you use a long key which is difficult for an attacker's software to guess – for example, a twenty-letter long string of apparently random numbers and letters – but it is not very secure if you use a short key which is very easy to guess – for example, a three-letter word from the dictionary.

Because of the damage that can be done by a malicious attacker, it is not just people who have sensitive information on their network who should use security. Everybody who uses any WiFi network should ensure that effective security is in place.

A good way to come up with effective security keys, passwords and so on is to use obscure information that you personally will easily remember, and to enter it in a way that appears random and does not include real words. For example, if your mother owns a 1970 Dodge Challenger and her favorite movie is

Vanishing Point (which you know was made in 1971) you could use "70dodchal71vanpoi" as your security key.

The following sections introduce different types of WiFi security you can set up in the WiFi network.

### 9.10.3.1 SSID

Normally, the Zyxel Device acts like a beacon and regularly broadcasts the SSID in the area. You can hide the SSID instead, in which case the Zyxel Device does not broadcast the SSID. In addition, you should change the default SSID to something that is difficult to guess.

This type of security is fairly weak, however, because there are ways for unauthorized WiFi devices to get the SSID. In addition, unauthorized WiFi devices can still see the information that is sent in the WiFi network.

### 9.10.3.2 MAC Address Filter

Every device that can use a WiFi network has a unique identification number, called a MAC address.<sup>1</sup> A MAC address is usually written using twelve hexadecimal characters<sup>2</sup>; for example, 00A0C5000002 or 00:A0:C5:00:00:02. To get the MAC address for each WiFi device in the WiFi network, see the WiFi device's User's Guide or other documentation.

You can use the MAC address filter to tell the Zyxel Device which devices are allowed or not allowed to use the WiFi network. If a WiFi device is allowed to use the WiFi network, it still has to have the correct information (SSID, channel, and security). If a WiFi device is not allowed to use the WiFi network, it does not matter if it has the correct information.


This type of security does not protect the information that is sent in the WiFi network. Furthermore, there are ways for unauthorized WiFi devices to get the MAC address of an authorized WiFi device. Then, they can use that MAC address to use the WiFi network.

### 9.10.3.3 Encryption

WiFi networks can use encryption to protect the information that is sent in the WiFi network. Encryption is like a secret code. If you do not know the secret code, you cannot understand the message.

The types of encryption you can choose depend on the type of authentication. (See [Section 9.10.3.3 on page 262](#) for information about this.)

Table 68 Types of Encryption for Each Type of Authentication

	NO AUTHENTICATION	RADIUS SERVER
<b>Weakest</b>	No Security	WPA
	WPA-PSK	WPA2
	WPA2	
<b>Strongest</b>	WPA3-SAE	WPA3 (server certificate validation)

1. Some wireless devices, such as scanners, can detect WiFi networks but cannot use WiFi networks. These kinds of wireless devices might not have MAC addresses.
2. Hexadecimal characters are 0, 1, 2, 3, 4, 5, 6, 7, 8, 9, A, B, C, D, E, and F.

For example, if the WiFi network has a RADIUS server, you can choose **WPA**, **WPA2**, or **WPA3**. If users do not log in to the WiFi network, you can choose no encryption, **WPA2-PSK**, or **WPA3-SAE**.

Note: It is recommended that WiFi networks use **WPA3-SAE**, **WPA2-PSK**, or stronger encryption. The other types of encryption are better than none at all, but it is still possible for unauthorized WiFi devices to figure out the original information pretty quickly.

Many types of encryption use a key to protect the information in the WiFi network. The longer the key, the stronger the encryption. Every device in the WiFi network must have the same key.

## 9.10.4 Signal Problems

Because WiFi networks are radio networks, their signals are subject to limitations of distance, interference and absorption.

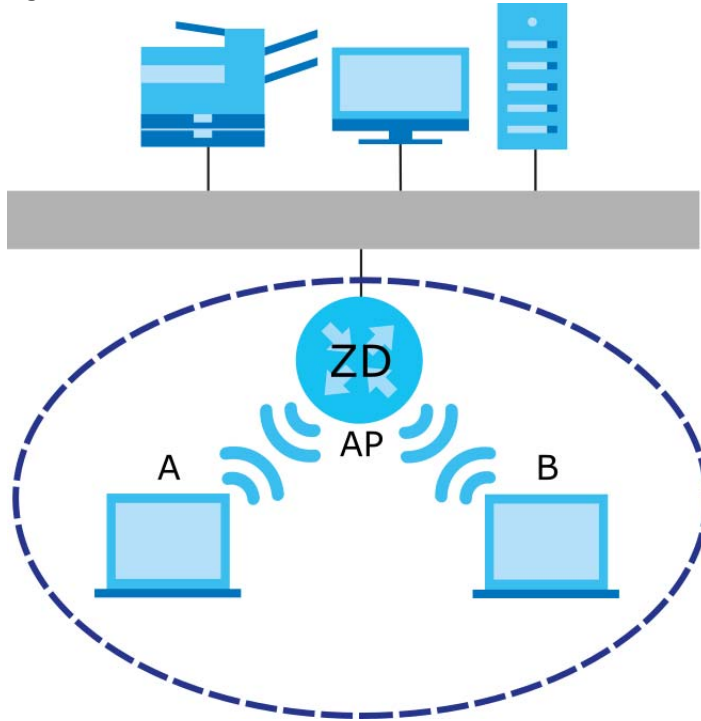
Problems with distance occur when the two radios are too far apart. Problems with interference occur when other radio waves interrupt the data signal. Interference may come from other radio transmissions, such as military or air traffic control communications, or from machines that are coincidental emitters such as electric motors or microwaves. Problems with absorption occur when physical objects (such as thick walls) are between the two radios, muffling the signal.

## 9.10.5 BSS

A Basic Service Set (BSS) exists when all communications between wireless stations go through one access point (AP).

Intra-BSS traffic is traffic between wireless stations in the BSS. When Intra-BSS traffic blocking is disabled, wireless station A and B can access the wired network and communicate with each other. When Intra-BSS traffic blocking is enabled, wireless station A and B can still access the wired network but cannot communicate with each other.

Figure 119 Basic Service Set



## 9.10.6 MBSSID

Traditionally, you need to use different APs to configure different Basic Service Sets (BSSs). As well as the cost of buying extra APs, there is also the possibility of channel interference. The Zyxel Device's MBSSID (Multiple Basic Service Set Identifier) function allows you to use one access point to provide several BSSs simultaneously. You can then assign varying QoS priorities and/or security modes to different SSIDs.

Wireless devices can use different BSSIDs to associate with the same AP.

### 9.10.6.1 Notes on Multiple BSSs

- A maximum of eight BSSs are allowed on one AP simultaneously.
- You must use different keys for different BSSs. If two wireless devices have different BSSIDs (they are in different BSSs), but have the same keys, they may hear each other's communications (but not communicate with each other).
- MBSSID should not replace but rather be used in conjunction with 802.1x security.

## 9.10.7 Preamble Type

Preamble is used to signal that data is coming to the receiver. Short and long refer to the length of the synchronization field in a packet.

Short preamble increases performance as less time sending preamble means more time for sending data. All IEEE 802.11 compliant WiFi adapters support long preamble, but not all support short preamble.

Use long preamble if you are unsure what preamble mode other WiFi devices on the network support, and to provide more reliable communications in busy WiFi networks.



Use short preamble if you are sure all WiFi devices on the network support it, and to provide more efficient communications.

Use the dynamic setting to automatically use short preamble when all WiFi devices on the network support it, otherwise the Zyxel Device uses long preamble.

Note: The WiFi devices **MUST** use the same preamble mode in order to communicate.

## 9.10.8 WiFi Protected Setup (WPS)

Your Zyxel Device supports WiFi Protected Setup (WPS), which is an easy way to set up a secure WiFi network. WPS is an industry standard specification, defined by the WiFi Alliance.

WPS allows you to quickly set up a WiFi network with strong security, without having to configure security settings manually. Each WPS connection works between two devices. Both devices must support WPS (check each device's documentation to make sure).

Depending on the devices you have, you can either press a button (on the device itself, or in its configuration utility) or enter a PIN (a unique Personal Identification Number that allows one device to authenticate the other) in each of the two devices. When WPS is activated on a device, it has 2 minutes to find another device that also has WPS activated. Then, the two devices connect and set up a secure network by themselves.

### 9.10.8.1 Push Button Configuration

WPS Push Button Configuration (PBC) is initiated by pressing a button on each WPS-enabled device, and allowing them to connect automatically. You do not need to enter any information.

Not every WPS-enabled device has a physical WPS button. Some may have a WPS PBC button in their configuration utilities instead of or in addition to the physical button.

Take the following steps to set up WPS using the button.

- 1 Ensure that the two devices you want to set up are within WiFi range of one another.
- 2 Look for a WPS button on each device. If the device does not have one, log into its configuration utility and locate the button (see the device's User's Guide for how to do this – for the Zyxel Device, see [Section 9.5 on page 250](#)).
- 3 Press the button on one of the devices (it doesn't matter which). For the Zyxel Device you must press the **WiFi** button for more than 5 seconds.
- 4 Within 2 minutes, press the button on the other device. The registrar sends the network name (SSID) and security key through a secure connection to the enrollee.

If you need to make sure that WPS worked, check the list of associated WiFi clients in the AP's configuration utility. If you see the WiFi client in the list, WPS was successful.

### 9.10.8.2 PIN Configuration

Each WPS-enabled device has its own PIN (Personal Identification Number). This may either be static (it cannot be changed) or dynamic (in some devices you can generate a new PIN by clicking on a button in the configuration interface).

Use the PIN method instead of the push-button configuration (PBC) method if you want to ensure that the connection is established between the devices you specify, not just the first two devices to activate WPS in range of each other. However, you need to log into the configuration interfaces of both devices to use the PIN method.

When you use the PIN method, you must enter the PIN from one device (usually the WiFi client) into the second device (usually the Access Point or wireless router). Then, when WPS is activated on the first device, it presents its PIN to the second device. If the PIN matches, one device sends the network and security information to the other, allowing it to join the network.

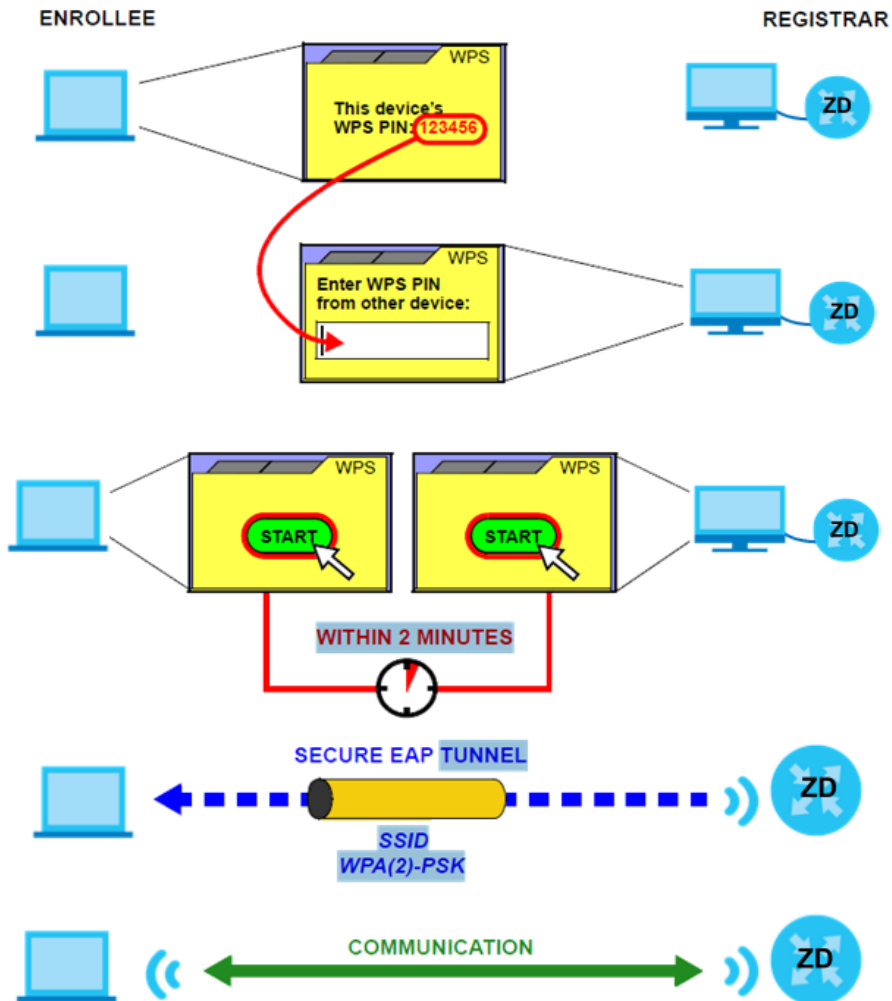
Take the following steps to set up a WPS connection between an access point or wireless router (referred to here as the AP) and a client device using the PIN method.

- 1** Ensure WPS is enabled on both devices.
- 2** Access the WPS section of the AP's configuration interface. See the device's User's Guide on how to do this.
- 3** Look for the client's WPS PIN; it will be displayed either on the device, or in the WPS section of the client's configuration interface (see the device's User's Guide on how to find the WPS PIN – for the Zyxel Device, see [Section 9.5 on page 250](#)).
- 4** Enter the client's PIN in the AP's configuration interface.
- 5** If the client device's configuration interface has an area for entering another device's PIN, you can either enter the client's PIN in the AP, or enter the AP's PIN in the client – it does not matter which.
- 6** Start WPS on both devices within two minutes.
- 7** Use the configuration utility to activate WPS, not the push-button on the device itself.
- 8** On a computer connected to the WiFi client, try to connect to the Internet. If you can connect, WPS was successful.

If you cannot connect, check the list of associated WiFi clients in the AP's configuration utility. If you see the WiFi client in the list, WPS was successful.

The following figure shows a WPS-enabled WiFi client (installed in a notebook computer) connecting to the WPS-enabled AP through the PIN method.

Figure 120 Example WPS Process: PIN Method

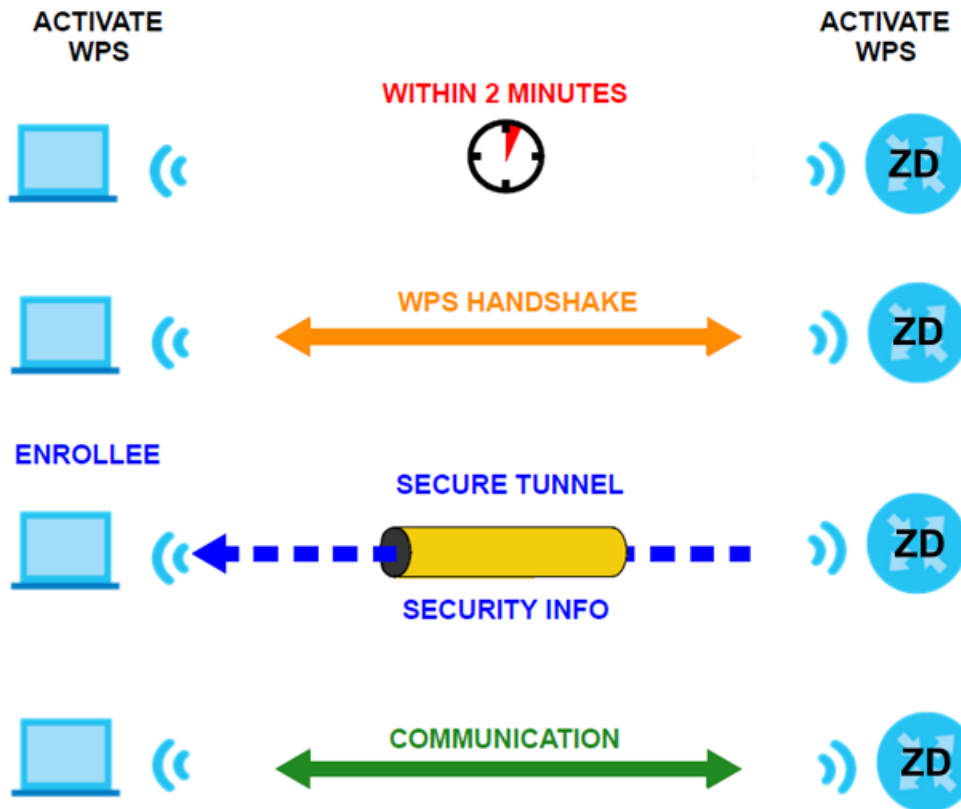


### 9.10.8.3 How WPS Works

When two WPS-enabled devices connect, each device must assume a specific role. One device acts as the registrar (the device that supplies network and security settings) and the other device acts as the enrollee (the device that receives network and security settings). The registrar creates a secure EAP (Extensible Authentication Protocol) tunnel and sends the network name (SSID) and the WPA-PSK or WPA2-PSK pre-shared key to the enrollee. Whether WPA-PSK or WPA2-PSK is used depends on the standards supported by the devices. If the registrar is already part of a network, it sends the existing information. If not, it generates the SSID and WPA2-PSK randomly.

The following figure shows a WPS-enabled client (installed in a notebook computer) connecting to a WPS-enabled access point.

Figure 121 How WPS Works



The roles of registrar and enrollee last only as long as the WPS setup process is active (2 minutes). The next time you use WPS, a different device can be the registrar if necessary.

The WPS connection process is like a handshake; only two devices participate in each WPS transaction. If you want to add more devices you should repeat the process with one of the existing networked devices and the new device.

Note that the access point (AP) is not always the registrar, and the WiFi client is not always the enrollee. All WPS-certified APs can be a registrar, and so can some WPS-enabled WiFi clients.

By default, a WPS device is 'un-configured'. This means that it is not part of an existing network and can act as either enrollee or registrar (if it supports both functions). If the registrar is un-configured, the security settings it transmits to the enrollee are randomly-generated. Once a WPS-enabled device has connected to another device using WPS, it becomes 'configured'. A configured WiFi client can still act as enrollee or registrar in subsequent WPS connections, but a configured access point can no longer act as enrollee. It will be the registrar in all subsequent WPS connections in which it is involved. If you want a configured AP to act as an enrollee, you must reset it to its factory defaults.

#### 9.10.8.4 Example WPS Network Setup

This section shows how security settings are distributed in a sample WPS setup.

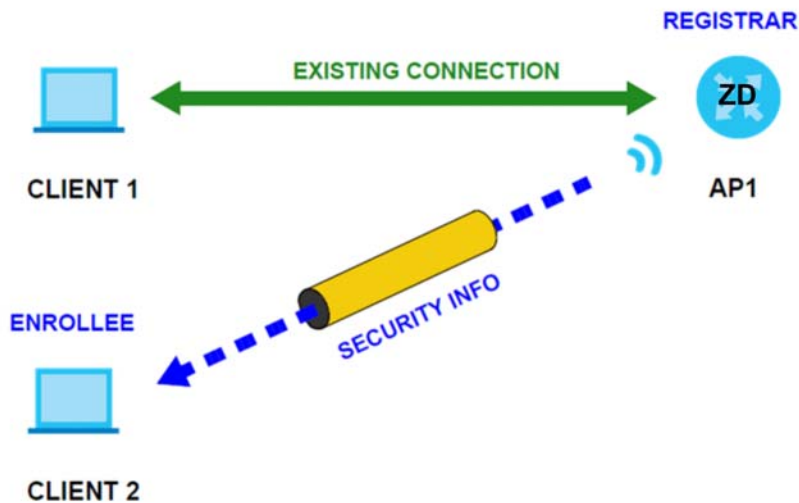
The following figure shows a sample network. In step 1, both **AP1** and **Client 1** are un-configured. When WPS is activated on both, they perform the handshake. In this example, **AP1** is the registrar, and **Client 1** is the enrollee. The registrar randomly generates the security information to set up the network, since it is un-configured and has no existing information.

Figure 122 WPS: Example Network Step 1



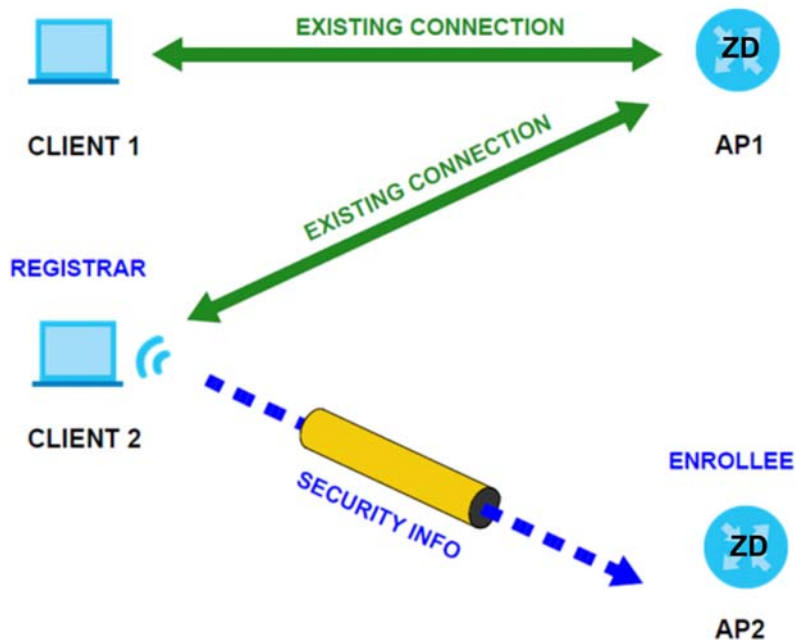
In step 2, you add another WiFi client to the network. You know that **Client 1** supports registrar mode, but it is better to use **AP1** for the WPS handshake with the new client since you must connect to the access point anyway in order to use the network. In this case, **AP1** must be the registrar, since it is configured (it already has security information for the network). **AP1** supplies the existing security information to **Client 2**.

Figure 123 WPS: Example Network Step 2



In step 3, you add another access point (**AP2**) to your network. **AP2** is out of range of **AP1**, so you cannot use **AP1** for the WPS handshake with the new access point. However, you know that **Client 2** supports the registrar function, so you use it to perform the WPS handshake instead.

Figure 124 WPS: Example Network Step 3



### 9.10.8.5 Limitations of WPS

WPS has some limitations of which you should be aware.

- When you use WPS, it works between two devices only. You cannot enroll multiple devices simultaneously, you must enroll one after the other.

For instance, if you have two enrollees and one registrar you must set up the first enrollee (by pressing the WPS button on the registrar and the first enrollee, for example), then check that it was successfully enrolled, then set up the second device in the same way.

- WPS works only with other WPS-enabled devices. However, you can still add non-WPS devices to a network you already set up using WPS.

WPS works by automatically issuing a randomly-generated WPA-PSK or WPA2-PSK pre-shared key from the registrar device to the enrollee devices. Whether the network uses WPA-PSK or WPA2-PSK depends on the device. You can check the configuration interface of the registrar device to discover the key the network is using (if the device supports this feature). Then, you can enter the key into the non-WPS device and join the network as normal (the non-WPS device must also support WPA-PSK or WPA2-PSK).

- When you use the PBC method, there is a short period (from the moment you press the button on one device to the moment you press the button on the other device) when any WPS-enabled device could join the network. This is because the registrar has no way of identifying the 'correct' enrollee, and cannot differentiate between your enrollee and a rogue device. This is a possible way for a hacker to gain access to a network.

You can easily check to see if this has happened. WPS only works simultaneously between two devices, so if another device has enrolled your device will be unable to enroll, and will not have access to the network. If this happens, open the access point's configuration interface and look at the list of associated clients (usually displayed by MAC address). It does not matter if the access point is the WPS registrar, the enrollee, or was not involved in the WPS handshake; a rogue device must still associate with the access point to gain access to the network. Check the MAC addresses of your WiFi clients (usually printed on a label on the bottom of the device). If there is an unknown MAC address you can remove it or reset the AP.

# CHAPTER 10

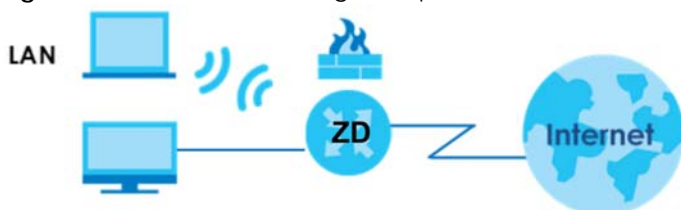
## Home Networking

### 10.1 Home Networking Overview

A Local Area Network (LAN) is a shared communication system to which many computers are attached. A LAN is usually located in one immediate area such as a building or floor of a building.

The LAN screens can help you configure a LAN DHCP server and manage IP addresses.

**Figure 125** Home Networking Example



#### 10.1.1 What You Can Do in this Chapter

- Use the **LAN Setup** screen to set the LAN IP address, subnet mask, and DHCP settings ([Section 10.2 on page 273](#)).
- Use the **Static DHCP** screen to assign IP addresses on the LAN to specific individual computers based on their MAC addresses ([Section 10.3 on page 279](#)).
- Use the **UPnP** screen to enable UPnP ([Section 10.4 on page 281](#)).
- Use the **Additional Subnet** screen to configure IP alias and public static IP ([Section 10.5 on page 282](#)).
- Use the **STB Vendor ID** screen to configure the Vendor IDs of the connected Set Top Box (STB) devices, which have the Zyxel Device automatically create static DHCP entries for the STB devices when they request IP addresses ([Section 10.6 on page 284](#)).
- Use the **Wake on LAN** screen to remotely turn on a device on the network. ([Section 10.7 on page 285](#)).
- Use the **TFTP Server Name** screen to identify a TFTP server for configuration file download using DHCP option 66. ([Section 10.8 on page 285](#)).
- Use the **APAS** screen to allow incoming traffic from any port to access any service on a LAN device ([Section 10.9 on page 286](#)).

#### 10.1.2 What You Need To Know

The following terms and concepts may help as you read this chapter.

## 10.1.2.1 About LAN

### IP Address

Similar to the way houses on a street share a common street name, so too do computers on a LAN share one common network number. This is known as an Internet Protocol address.

### Subnet Mask

The subnet mask specifies the network number portion of an IP address. Your Zyxel Device will compute the subnet mask automatically based on the IP address that you entered. You do not need to change the subnet mask computed by the Zyxel Device unless you are instructed to do otherwise.

### DHCP

DHCP (Dynamic Host Configuration Protocol) allows clients to obtain TCP/IP configuration at start-up from a server. This Zyxel Device has a built-in DHCP server capability that assigns IP addresses and DNS servers to systems that support DHCP client capability.

### DNS

DNS (Domain Name System) maps a domain name to its corresponding IP address and vice versa. The DNS server is extremely important because without it, you must know the IP address of a computer before you can access it. The DNS server addresses you enter when you set up DHCP are passed to the client machines along with the assigned IP address and subnet mask.

### RADVD (Router Advertisement Daemon)

When an IPv6 host sends a Router Solicitation (RS) request to discover the available routers, RADVD with Router Advertisement (RA) messages in response to the request. It specifies the minimum and maximum intervals of RA broadcasts. RA messages containing the address prefix. IPv6 hosts can be generated with the IPv6 prefix an IPv6 address.

## 10.1.2.2 About UPnP

### How do I know if I am using UPnP?

UPnP hardware is identified as an icon in the Network Connections folder (Windows 7). Each UPnP compatible device installed on your network will appear as a separate icon. Selecting the icon of a UPnP device will allow you to access the information and properties of that device.

### NAT Traversal

UPnP NAT traversal automates the process of allowing an application to operate through NAT. UPnP network devices can automatically configure network addressing, announce their presence in the network to other UPnP devices and enable exchange of simple product and service descriptions. NAT traversal allows the following:

- Dynamic port mapping
- Learning public IP addresses



- Assigning lease times to mappings

Windows Messenger is an example of an application that supports NAT traversal and UPnP.

### Cautions with UPnP

The automated nature of NAT traversal applications in establishing their own services and opening firewall ports may present network security issues. Network information and configuration may also be obtained and modified by users in some network environments.

When a UPnP device joins a network, it announces its presence with a multicast message. For security reasons, the Zyxel Device allows multicast messages on the LAN only.

All UPnP-enabled devices may communicate freely with each other without additional configuration. Disable UPnP if this is not your intention.

### UPnP and Zyxel

Zyxel has achieved UPnP certification from the Universal Plug and Play Forum UPnP™ Implementers Corp. (UIC).

See [Section 10.11 on page 291](#) for examples on installing and using UPnP.

## 10.1.3 Before You Begin

Find out the MAC addresses of your network devices if you intend to add them to the DHCP Client List screen.

## 10.2 LAN Setup

A LAN IP address is the IP address of a networking device in the LAN. You can use the Zyxel Device's LAN IP address to access its Web Configurator from the LAN. The DHCP server settings define the rules on assigning IP addresses to LAN clients on your network.

Use this screen to set the Local Area Network IP address and subnet mask of your Zyxel Device. Configure DHCP settings to have the Zyxel Device or a DHCP server assign IP addresses to devices. Click **Network Setting > Home Networking** to open the **LAN Setup** screen.

Follow these steps to configure your LAN settings.

- 1 Enter an IP address into the **IP Address** field. The IP address must be in dotted decimal notation. This will become the IP address of your Zyxel Device.
- 2 Enter the IP subnet mask into the **IP Subnet Mask** field. Unless instructed otherwise it is best to leave this alone, the configurator will automatically compute a subnet mask based upon the IP address you entered.
- 3 Click **Apply** to save your settings.

**Figure 126** Network Setting > Home Networking > LAN Setup

Use this screen to set the Local Area Network IP address and subnet mask of your Zyxel Device. Configure DHCP settings to have the Zyxel Device or a DHCP server assign IP addresses to devices.

**Interface Group**

Group Name

**LAN IP Setup**

IP Address  .  .  .

Subnet Mask  .  .  .

**DHCP Server State**

DHCP  Enable  Disable  DHCP Relay

**IP Addressing Values**

Beginning IP Address  .  .  .

Ending IP Address  .  .  .

Auto reserve IP for the same host

**DHCP Server Lease Time**

days  hours  minutes

**DNS Values**

DNS  DNS Proxy  Static  From ISP

**Figure 127** Network Setting > Home Networking > LAN Setup (Continued)

**LAN IPv6 Mode Setup**

IPv6 Active

**Link Local Address Type**

EUI64

Manual

**LAN Global Identifier Type**

EUI64

Manual

**LAN IPv6 Prefix Setup**

Delegate prefix from WAN

Static

**LAN IPv6 Address Assign Setup**

**LAN IPv6 DNS Assign Setup**

**DHCPv6 Configuration**

DHCPv6 Active  DHCPv6 Server

**IPv6 Router Advertisement State**

RADVD Active  Enable

**IPv6 DNS Values**

IPv6 DNS Server 1

IPv6 DNS Server 2

IPv6 DNS Server 3

**DNS Query Scenario**

The following table describes the fields in this screen.

**Table 69** Network Setting > Home Networking > LAN Setup

LABEL	DESCRIPTION
Interface Group	
Group Name	Select the interface group that you want to configure its LAN settings.
LAN IP Setup	

Table 69 Network Setting &gt; Home Networking &gt; LAN Setup (continued)

LABEL	DESCRIPTION
IP Address	Enter the LAN IP address you want to assign to your Zyxel Device in dotted decimal notation, for example, 192.168.1.1 (factory default).
Subnet Mask	Enter the subnet mask of your network in dotted decimal notation, for example 255.255.255.0 (factory default). Your Zyxel Device automatically computes the subnet mask based on the IP address you enter, so do not change this field unless you are instructed to do so.
IGMP Snooping See <a href="#">Section 15.1 on page 355</a> for more information on IGMP snooping.	
Active	Select <b>Enable</b> to allow the Zyxel Device to passively learn multicast group.
IGMP Mode	Select <b>Standard Mode</b> to forward multicast packets to a port that joins the multicast group and broadcast unknown multicast packets from the WAN to all LAN ports.  Select <b>Blocking Mode</b> to block all unknown multicast packets from the WAN.
DHCP Server State	
DHCP	Select <b>Enable</b> to have your Zyxel Device assign IP addresses, an IP default gateway and DNS servers to LAN computers and other devices that are DHCP clients.  If you select <b>Disable</b> , you need to manually configure the IP addresses of the computers and other devices on your LAN.  If you select <b>DHCP Relay</b> , the Zyxel Device acts as a surrogate DHCP server and relays DHCP requests and responses between the remote server and the clients.
DHCP Relay Server Address This field is only available when you select <b>DHCP Relay</b> in the <b>DHCP</b> field.	
IP Address	Enter the IPv4 IP address of the actual remote DHCP server in this field.
IP Addressing Values The <b>IP Addressing Values</b> fields appear only when you select <b>Enable</b> in the <b>DHCP</b> field.	
Beginning IP Address	This field specifies the first of the contiguous addresses in the IP address pool.
Ending IP Address	This field specifies the last of the contiguous addresses in the IP address pool.
Auto reserve IP for the same host	Enable this if you want to reserve the IP address for the same host.
DHCP Server Lease Time  This is the period of time DHCP-assigned addresses is used. DHCP automatically assigns IP addresses to clients when they log in. DHCP centralizes IP address management on central computers that run the DHCP server program. DHCP leases addresses, for a period of time, which means that past addresses are "recycled" and made available for future reassignment to other systems.  This field is only available when you select <b>Enable</b> in the <b>DHCP</b> field.	
Days/Hours/Minutes	DHCP server leases an address to a new client device for a period of time, called the DHCP lease time. When the lease expires, the DHCP server might assign the IP address to a different client device.
DNS Values This field appears only when you select <b>Enable</b> in the <b>DHCP</b> field.	

Table 69 Network Setting &gt; Home Networking &gt; LAN Setup (continued)

LABEL	DESCRIPTION						
DNS	<p>The Zyxel Device supports DNS proxy by default. The Zyxel Device sends out its own LAN IP address to the DHCP clients as the first DNS server address. DHCP clients use this first DNS server to send domain-name queries to the Zyxel Device. The Zyxel Device sends a response directly if it has a record of the domain-name to IP address mapping. If it does not, the Zyxel Device queries an outside DNS server and relays the response to the DHCP client.</p> <p>Select <b>DNS Proxy</b> to have the DHCP clients use the Zyxel Device's own LAN IP address. The Zyxel Device works as a DNS relay.</p> <p>Select <b>Static</b> if you have the IP address of a DNS server. Enter the DNS server's IP address in the field to the right.</p> <p>Select <b>From ISP</b> if your ISP dynamically assigns DNS server information (and the Zyxel Device's WAN IP address).</p>						
LAN IPv6 Mode Setup							
IPv6 Active	<p>Use this to enable or disable IPv6 on the Zyxel Device.</p> <p>When IPv6 is used, the following fields need to be set.</p>						
Link Local Address Type	<p>A link-local address uniquely identifies a device on the local network (the LAN). It is similar to a "private IP address" in IPv6. You can have the same link-local address on multiple interfaces on a device. A link-local unicast address has a predefined prefix of fe80::/10. The link-local unicast address format is as follows. Select <b>EUI64</b> to allow the Zyxel Device to generate an interface ID for the LAN interface's link-local address using the EUI-64 format. Otherwise, enter an interface ID for the LAN interface's link-local address if you select <b>Manual</b>.</p> <p>Link-local Unicast Address Format</p> <table border="1" data-bbox="526 1003 980 1083"> <tbody> <tr> <td data-bbox="526 1003 695 1037">1111 1110 10</td> <td data-bbox="695 1003 792 1037">0</td> <td data-bbox="792 1003 980 1037">Interface ID</td> </tr> <tr> <td data-bbox="526 1037 695 1083">10 bits</td> <td data-bbox="695 1037 792 1083">54 bits</td> <td data-bbox="792 1037 980 1083">64 bits</td> </tr> </tbody> </table>	1111 1110 10	0	Interface ID	10 bits	54 bits	64 bits
1111 1110 10	0	Interface ID					
10 bits	54 bits	64 bits					
EUI64	Select this to have the Zyxel Device generate an interface ID for the LAN interface's link-local address using the EUI-64 format.						
Manual	Select this to manually enter an interface ID for the LAN interface's link-local address.						
LAN Global Identifier Type	Select <b>EUI64</b> to have the Zyxel Device generate an interface ID using the EUI-64 format for its global address. Select <b>Manual</b> to manually enter an interface ID for the LAN interface's global IPv6 address.						
EUI64	Select this to have the Zyxel Device generate an interface ID using the EUI-64 format for its global address.						
Manual	Select this to manually enter an interface ID for the LAN interface's global IPv6 address.						
LAN IPv6 Prefix Setup	Select <b>Delegate prefix from WAN</b> to automatically obtain an IPv6 network prefix from the service provider or an uplink router. Select <b>Static</b> to configure a fixed IPv6 address for the Zyxel Device's LAN IPv6 address.						
Delegate prefix from WAN	Select this option to automatically obtain an IPv6 network prefix from the service provider or an uplink router.						
Static	Select this option to configure a fixed IPv6 address for the Zyxel Device's LAN IPv6 address.						
MLD Snooping / Multicast Snooping	Multicast Listener Discovery (MLD) allows an IPv6 switch or router to discover the presence of MLD hosts who wish to receive multicast packets and the IP addresses of multicast groups the hosts want to join on its network.						
Active	<p>Click this switch to enable or disable MLD Snooping on the Zyxel Device. When the switch goes to the right the function is enabled. Otherwise, it is not.</p> <p>This allows the Zyxel Device to check MLD packets passing through it and learn the multicast group membership. It helps reduce multicast traffic.</p>						

Table 69 Network Setting &gt; Home Networking &gt; LAN Setup (continued)

LABEL	DESCRIPTION
MLD Mode	<p>Select <b>Standard Mode</b> to forward multicast packets to a port that joins the multicast group and broadcast unknown multicast packets from the WAN to all LAN ports.</p> <p>Select <b>Blocking Mode</b> to block all unknown multicast packets from the WAN.</p>
LAN IPv6 Address Assign Setup	<p>Select how you want to obtain an IPv6 address:</p> <p><b>Stateless:</b> The Zyxel Device uses IPv6 stateless auto-configuration. RADVD (Router Advertisement Daemon) is enabled to have the Zyxel Device send IPv6 prefix information in router advertisements periodically and in response to router solicitations. DHCPv6 server is disabled.</p> <p><b>Stateful:</b> The Zyxel Device uses IPv6 stateful auto-configuration. The DHCPv6 server is enabled to have the Zyxel Device act as a DHCPv6 server and pass IPv6 addresses to DHCPv6 clients.</p>
LAN IPv6 DNS Assign Setup	<p>Select how the Zyxel Device provide DNS server and domain name information to the clients:</p> <p><b>From RA &amp; DHCPv6 Server:</b> The Zyxel Device provides DNS information through both router advertisements and DHCPv6.</p> <p><b>From DHCPv6 Server:</b> The Zyxel Device provides DNS information through DHCPv6.</p> <p><b>From Router Advertisement:</b> The Zyxel Device provides DNS information through router advertisements.</p>
DHCPv6 Configuration	
DHCPv6 Active	This shows the status of the DHCPv6. <b>DHCP Server</b> displays if you configured the Zyxel Device to act as a DHCPv6 server which assigns IPv6 addresses and/or DNS information to clients.
IPv6 Router Advertisement State	
RADVD Active	This shows whether RADVD is enabled or not.
IPv6 Address Values	
IPv6 Start Address	This field specifies the first of the contiguous addresses in the IPv6 address pool.
IPv6 End Address	This field specifies the last of the contiguous addresses in the IPv6 address pool.
IPv6 Domain Name	The field specifies the domain name of the IPv6 address.
IPv6 DNS Values	
IPv6 DNS Server 1 – 3	<p>Specify the IP addresses up to three DNS servers for the DHCP clients to use. Use one of the following ways to specify these IP addresses.</p> <p><b>User Defined</b> – Select this if you have the IPv6 address of a DNS server. Enter the DNS server IPv6 addresses the Zyxel Device passes to the DHCP clients.</p> <p><b>From ISP</b> – Select this if your ISP dynamically assigns IPv6 DNS server information.</p> <p><b>Proxy</b> – Select this if the DHCP clients use the IP address of this interface and the Zyxel Device works as a DNS relay.</p> <p>Otherwise, select <b>None</b> if you do not want to configure IPv6 DNS servers.</p>

Table 69 Network Setting &gt; Home Networking &gt; LAN Setup (continued)

LABEL	DESCRIPTION
DNS Query Scenario	<p>Select how the Zyxel Device handles clients' DNS information requests.</p> <p><b>IPv4/IPv6 DNS Server:</b> The Zyxel Device forwards the requests to both the IPv4 and IPv6 DNS servers and sends clients the first DNS information it receives.</p> <p><b>IPv6 DNS Server Only:</b> The Zyxel Device forwards the requests to the IPv6 DNS server and sends clients the DNS information it receives.</p> <p><b>IPv4 DNS Server Only:</b> The Zyxel Device forwards the requests to the IPv4 DNS server and sends clients the DNS information it receives.</p> <p><b>IPv6 DNS Server First:</b> The Zyxel Device forwards the requests to the IPv6 DNS server first and then the IPv4 DNS server. Then it sends clients the first DNS information it receives.</p> <p><b>IPv4 DNS Server First:</b> The Zyxel Device forwards the requests to the IPv4 DNS server first and then the IPv6 DNS server. Then it sends clients the first DNS information it receives.</p>
Apply	Click <b>Apply</b> to save your changes.
Cancel	Click <b>Cancel</b> to restore your previously saved settings.

## 10.3 Static DHCP

When any of the LAN clients in your network want an assigned fixed IP address, add a static lease for each LAN client. Knowing the LAN client's MAC addresses is necessary. This table allows you to assign IP addresses on the LAN to individual computers based on their MAC addresses.

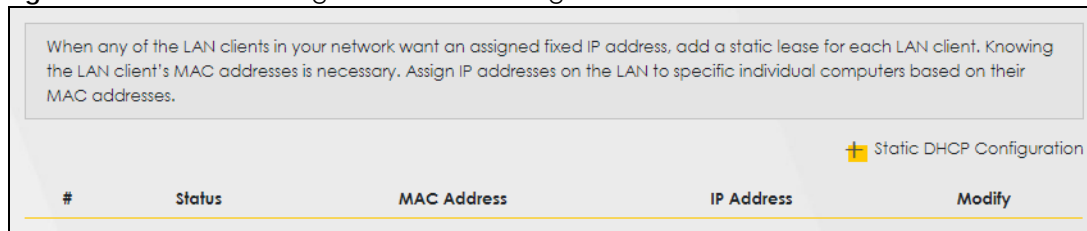
Every Ethernet device has a unique MAC (Media Access Control) address. The MAC address is assigned at the factory and consists of six pairs of hexadecimal characters, for example, 00:A0:C5:00:00:02.

### 10.3.1 Before You Begin

Find out the MAC addresses of your network devices if you intend to add them to the **Static DHCP** screen.

Use this screen to change your Zyxel Device's static DHCP settings. Click **Network Setting > Home Networking > Static DHCP** to open the following screen.

**Figure 128** Network Setting > Home Networking > Static DHCP



The following table describes the labels in this screen.

Table 70 Network Setting > Home Networking > Static DHCP

LABEL	DESCRIPTION
Static DHCP Configuration	Click this to configure a static DHCP entry.
#	This is the index number of the entry.
Status	This field displays whether the client is connected to the Zyxel Device.
MAC Address	The MAC (Media Access Control) or Ethernet address on a LAN (Local Area Network) is unique to your computer (six pairs of hexadecimal notation).  A network interface card such as an Ethernet adapter has a hardwired address that is assigned at the factory. This address follows an industry standard that ensures no other adapter has a similar address.
IP Address	This field displays the IP address relative to the # field listed above.
Modify	Click the <b>Edit</b> icon to configure the connection.  Click the <b>Delete</b> icon to remove the connection.

If you click **Static DHCP Configuration** in the **Static DHCP** screen, the following screen displays. Using a static DHCP means a LAN client will always have the same IP address assigned to it by the DHCP server. Assign a fixed IP address to a client device by selecting the interface group of this client device and its IP address type and selecting the device/computer from a list or manually entering its MAC address and assigned IP address.

Figure 129 Network Setting > Home Networking > Static DHCP: Static DHCP Configuration

The following table describes the labels in this screen.

Table 71 Network Setting > Home Networking > Static DHCP: Static DHCP Configuration

LABEL	DESCRIPTION
Active	Select <b>Enable</b> to activate static DHCP in your Zyxel Device.
Group Name	Select the interface group for which you want to configure the static DHCP settings.
IP Type	The <b>IP Type</b> is normally <b>IPv4</b> (non-configurable).
Select Device Info	Select between <b>Manual Input</b> which allows you to enter the next two fields ( <b>MAC Address</b> and <b>IP Address</b> ); or select an existing LAN device to show its MAC address and IP address.
MAC Address	Enter the MAC address of a computer on your LAN if you select <b>Manual Input</b> in the previous field.



Table 71 Network Setting &gt; Home Networking &gt; Static DHCP: Static DHCP Configuration (continued)

LABEL	DESCRIPTION
IP Address	Enter the IP address that you want to assign to the computer on your LAN with the MAC address that you will also specify if you select <b>Manual Input</b> in the previous field.
OK	Click <b>OK</b> to save your changes.
Cancel	Click <b>Cancel</b> to exit this screen without saving.

## 10.4 UPnP

Universal Plug and Play (UPnP) is an open networking standard that uses TCP/IP for simple peer-to-peer network connectivity between networking devices or software applications which have UPnP enabled. A UPnP device can dynamically join a network, obtain an IP address, advertise its services, and learn about other devices on the network. A device can also leave a network automatically when it is no longer in use.

See [Section 10.11 on page 291](#) for more information on UPnP.

Note: To use **UPnP NAT-T**, enable **NAT** in the **Network Setting > Broadband > Edit or Add New WAN Interface** screen.

Use the following screen to configure the UPnP settings on your Zyxel Device. Click **Network Setting > Home Networking > UPnP** to display the screen shown next.

Figure 130 Network Setting &gt; Home Networking &gt; UPnP

Universal Plug and Play (UPnP) is a distributed, open networking standard that uses TCP/IP for simple peer-to-peer network connectivity between networking devices and software that also have UPnP enabled. A UPnP device can dynamically join a network, obtain an IP address, convey its capabilities and learn about other devices on the network. A device can leave a network smoothly and automatically when it is no longer in use.

**UPnP State**

UPnP

**UPnP NAT-T State**

UPnP NAT-T

**Note**

UPnP NAT-T only works when NAT is enable

#	Description	Destination IP Address	External Port	Internal Port	Protocol
<input type="button" value="Cancel"/> <input checked="" type="button" value="Apply"/>					

The following table describes the labels in this screen.

Table 72 Network Settings > Home Networking > UPnP

LABEL	DESCRIPTION
UPnP State	
UPnP	Select <b>Enable</b> to activate UPnP. Be aware that anyone could use a UPnP application to open the Web Configurator's login screen without entering the Zyxel Device's IP address (although you must still enter the password to access the Web Configurator).
UPnP NAT-T State	
UPnP NAT-T	Select <b>Enable</b> to activate UPnP with NAT enabled. UPnP NAT traversal automates the process of allowing an application to operate through NAT. UPnP network devices can automatically configure network addressing, announce their presence in the network to other UPnP devices and enable exchange of simple product and service descriptions.
#	This field displays the index number of the entry.
Description	This field displays the description of the UPnP NAT-T connection.
Destination IP Address	This field displays the IP address of the other connected UPnP-enabled device.
External Port	This field displays the external port number that identifies the service.
Internal Port	This field displays the internal port number that identifies the service.
Protocol	This field displays the protocol of the NAT mapping rule. Choices are <b>TCP</b> or <b>UDP</b> .
Apply	Click <b>Apply</b> to save your changes.
Cancel	Click <b>Cancel</b> to restore your previously saved settings.

## 10.5 LAN Additional Subnet

Use this screen to configure IP alias and public static IP.

IP alias allows you to partition a physical network into different logical networks over the same Ethernet interface. The Zyxel Device supports multiple logical LAN interfaces through its physical Ethernet interface with the Zyxel Device itself as the gateway for the LAN network. When you use IP alias, you can also configure firewall rules to control access to the LAN's logical network (subnet).

If your ISP provides the **Public LAN** service, the Zyxel Device may use a LAN IP address that can be accessed from the WAN.

Click **Network Setting > Home Networking > Additional Subnet** to display the screen shown next.

Figure 131 Network Setting &gt; Home Networking &gt; Additional Subnet

## Home Networking

LAN Setup Static DHCP UPnP Additional Subnet STB Vendor ID Wake on LAN TFTP Server Name

Use this screen to configure IP alias and public static IP. IP alias allows you to partition a physical network into different logical networks over the same Ethernet interface. The Zyxel Device supports multiple logical LAN interfaces via its physical Ethernet interface with the Zyxel Device itself as the gateway for the LAN network. When you use IP alias, you can also configure firewall rules to control access to the LAN's logical network (subnet).

If your ISP provides the **Public LAN** service, the Zyxel Device may use a LAN IP address that can be accessed from the WAN.

### IP Alias Setup

Group Name:

Active:

IPv4 Address:

Subnet Mask:

### Public LAN

Active:

IPv4 Address:

Subnet Mask:

Offer Public IP by DHCP:

Enable ARP Proxy:

Cancel Apply

The following table describes the labels in this screen.

Table 73 Network Setting &gt; Home Networking &gt; Additional Subnet

LABEL	DESCRIPTION
IP Alias Setup	
Group Name	Select the interface group name for which you want to configure the IP alias settings.
Active	Click this switch to enable a logical LAN for the Zyxel Device. When this is enabled, the following fields will be configurable.
IPv4 Address	Enter the IP address of your Zyxel Device in dotted decimal notation.
Subnet Mask	Your Zyxel Device will automatically calculate the subnet mask based on the IPv4 address that you assign. Unless you are implementing subnetting, use this value computed by the Zyxel Device.
Public LAN	
Active	Click this switch to enable or disable the Public LAN feature. Your ISP must support Public LAN and static IP.
IPv4 Address	Enter the public IP address provided by your ISP.

Table 73 Network Setting &gt; Home Networking &gt; Additional Subnet (continued)

LABEL	DESCRIPTION
Subnet Mask	Enter the public IPv4 subnet mask provided by your ISP.
Offer Public IP by DHCP	Click this switch to enable the Zyxel Device to provide public IP addresses by DHCP server. Otherwise, click to disable.
Enable ARP Proxy	Click this switch to enable the Address Resolution Protocol (ARP) proxy. Otherwise, click to disable.
Cancel	Click <b>Cancel</b> to restore your previously saved settings.
Apply	Click <b>Apply</b> to save your changes.

## 10.6 STB Vendor ID

Use this screen to configure the Vendor IDs of connected Set Top Boxes (STBs) so the Zyxel Device can automatically create static DHCP entries for them when they request IP addresses.

Click **Network Setting > Home Networking > STB Vendor ID** to open this screen.

Figure 132 Network Setting &gt; Home Networking &gt; STB Vendor ID

The following table describes the labels in this screen.

Table 74 Network Setting &gt; Home Networking &gt; STB Vendor ID

LABEL	DESCRIPTION
Vendor ID 1 – 5	These are STB's Vendor Class Identifiers (DHCP option 60). A Vendor Class Identifier is usually used to inform the DHCP server a DHCP client's vendor and functionality.
Cancel	Click <b>Cancel</b> to restore your previously saved settings.
Apply	Click <b>Apply</b> to save your changes.

## 10.7 Wake on LAN

Wake on LAN (WoL) allows you to remotely turn on a device on the network, such as a computer, storage device or media server. To use this feature, the remote hardware (for example the network adapter on a computer) must support Wake on LAN using the 'Magic Packet' method.

You need to know the MAC address of the LAN device. It may be on a label on the LAN device.

Click **Network Setting > Home Networking > Wake on LAN** to open this screen.

**Figure 133** Network Setting > Home Networking > Wake on LAN

The following table describes the labels in this screen.

**Table 75** Network Setting > Home Networking > Wake on LAN

LABEL	DESCRIPTION
Wake by Address	Select <b>Manual</b> and enter the IP address or MAC address of the LAN device to turn it on remotely. The drop-down list also lists the IP addresses that can be found in the Zyxel Device's ARP table. If you select an IP address, the MAC address of the LAN device with the selected IP address then displays in the <b>MAC Address</b> field.
IP Address	Enter the IPv4 IP address of the LAN device to turn it on. This field is not available if you select an IP address in the <b>Wake by Address</b> field.
MAC Address	Enter the MAC address of the LAN device to turn it on. A MAC address consists of six hexadecimal character pairs.
Wake Up	Click this to send a WoL magic packet to wake up the specified LAN device.

## 10.8 TFTP Server Name

Use the **TFTP Server Name** screen to identify a TFTP server for configuration file download using DHCP option 66. RFC 2132 defines the option 66 open standard. DHCP option 66 supports the IP address or the host name of a single TFTP server.

Click **Network Setting > Home Networking > TFTP Server Name** to open this screen.

**Figure 134** Network Setting > Home Networking > TFTP Server Name

The following table describes the labels in this screen.

**Table 76** Network Setting > Home Networking > TFTP Server Name

LABEL	DESCRIPTION
TFTP Server Name	Enter the IP address or the host name of a single TFTP server.
Cancel	Click <b>Cancel</b> to restore your previously saved settings.
Apply	Click <b>Apply</b> to save your changes.

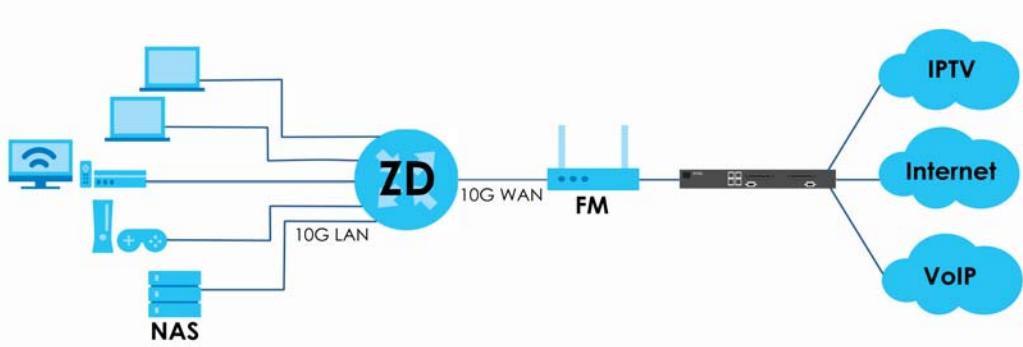
## 10.9 APAS

**Any Port Any Service (APAS)** allows a LAN device to use any available port to access any available service from a remote WAN device. Typically, a LAN device, such as a Set Top Box (STB), would have to use a specific port to access video streams from a video server. With APAS, the video streams only need to be received through the specified Bridge WAN interface for the LAN device specified in the APAS rule. You can connect the LAN device to any LAN port. Other LAN devices can access the Internet using the default gateway.

Unlike **Port Forwarding**, which forwards traffic based on port numbers, you do not need to know the port number for the video traffic from the IPTV server. You just select the LAN device host name or enter its MAC address and select a Bridge WAN interface.

Use the wildcard '\*' for a range of MAC addresses for multiple LAN devices. For example, enter 00:13:49:\*:\* for all LAN devices from a vendor with the MAC OUI 00:13:49. (range). Any device with that MAC OUI aa:bb:cc connected to any LAN port on the Zyxel Device can access services or can be accessed for services through the specified Bridge WAN interface. For example, the LAN device could be an STB receiving video streams from a video server, or it could be a server, allowing access to it through the specified Bridge WAN interface.

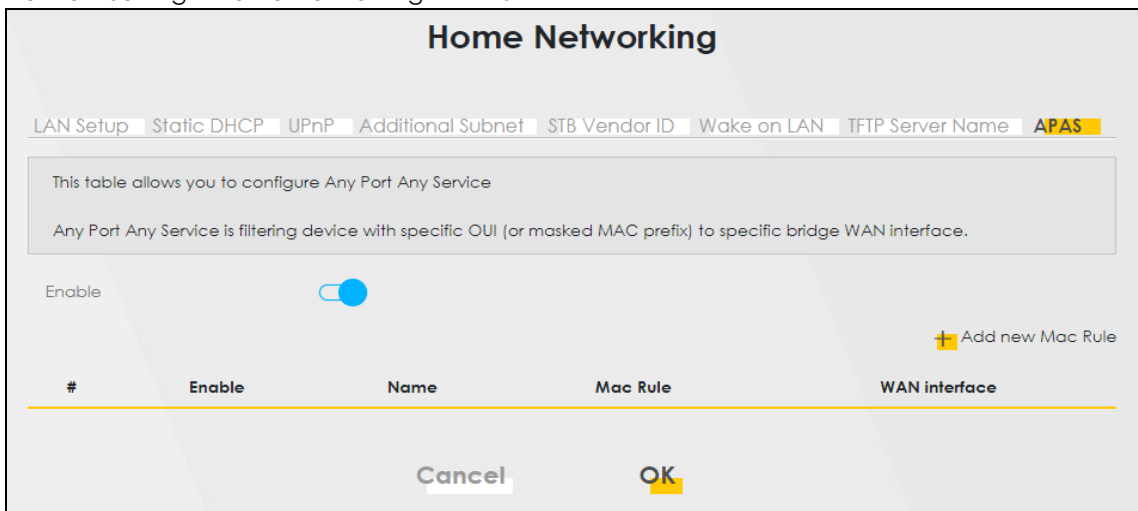
Note: You must configure a Bridge WAN interface in advance.



As APAS allows incoming traffic from any port to access any service on a configured LAN device, it may be difficult to distinguish between appropriate and malicious traffic going to the LAN device. Make sure to properly configure firewall rules to protect the LAN device, and monitor network traffic for suspicious activity.

Click **Network Setting > Home Networking > APAS** to open this screen.

Network Setting > Home Networking > APAS



The following table describes the labels in this screen.

Table 77 Network Setting > Home Networking > APAS

LABEL	DESCRIPTION
Enable	Click <b>Enable</b> to activate APAS.
Add new MAC Rule	Click this button to add a new MAC rule. You can create up to eight MAC rules.
#	This is the index number.
Name	This is the name of the rule.
MAC Rule	This is the LAN host MAC address that is applied to the rule.
WAN Interface	This is the bridge WAN interface for incoming traffic.
Cancel	Click <b>Cancel</b> to restore your previously saved changes.
OK	Click <b>OK</b> to save your changes.

## 10.9.1 Add APAS

Use this screen to create a new MAC rule. Click **Network Setting > Home Networking > APAS > Add New MAC Rule** to open the following screen.

**Figure 135** Network Setting > Home Networking > APAS > Add New MAC Rule

The following table describes the labels in this screen.

**Table 78** Network Setting > Home Networking > APAS > Add New MAC Rule

LABEL	DESCRIPTION
Enable	Click this to enable APAS on the Zyxel Device.
Name	Enter a name of up to 64 characters for the <b>APAS</b> rule to this host(s). Allowed characters for <b>Name</b> include the following within quotes: " !#%()*+,-./0123456789:=?@ABCDEFGHIJKLMNPOQRSTUVWXYZ[\_abcdefghijklmnopqrstuvwxyz~"
Select Device Info	Select a connected LAN host or select <b>Manual Input</b> to enter the MAC address of a client that is not yet connected and does not display in <b>Connection Status &gt; Connectivity</b> .
MAC Rule	If you selected <b>Manual Input</b> for <b>Select Device Info</b> , then enter the LAN host MAC address here. You can use the wildcard '*' for a MAC address range. For example, enter 00:13:49:*:* for all LAN devices from a vendor with the MAC OUI 00:13:49.
Bridge WAN Name	Select a Bridge WAN interface for incoming traffic to apply the rule. You must have created at least one Bridge WAN interface in <b>Network Setting &gt; Broadband</b> screen.
Cancel	Click <b>Cancel</b> to exit this screen without saving.
OK	Click <b>OK</b> to save your changes.

## 10.10 Technical Reference

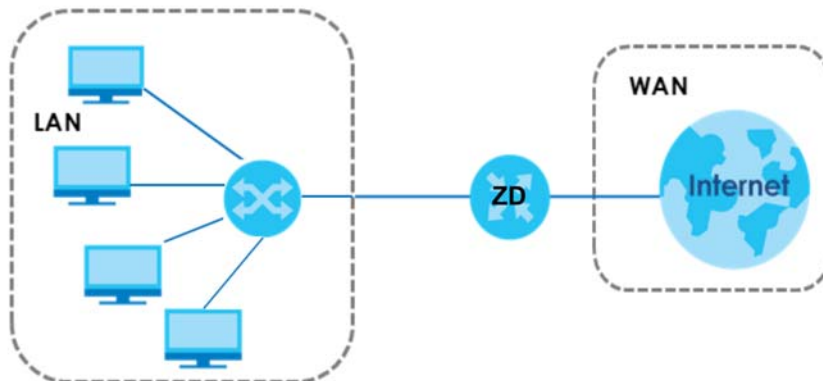
This section provides some technical background information about the topics covered in this chapter.



## LANs, WANs and the Zyxel Device

The actual physical connection determines whether the Zyxel Device ports are LAN or WAN ports. There are two separate IP networks, one inside the LAN network and the other outside the WAN network as shown next.

**Figure 136** LAN and WAN IP Addresses



### 10.10.1 DHCP Setup

DHCP (Dynamic Host Configuration Protocol, RFC 2131 and RFC 2132) allows individual clients to obtain TCP/IP configuration at start-up from a server. You can configure the Zyxel Device as a DHCP server or disable it. When configured as a server, the Zyxel Device provides the TCP/IP configuration for the clients. If you turn DHCP service off, you must have another DHCP server on your LAN, or else the computer must be manually configured.

#### IP Pool Setup

The Zyxel Device is pre-configured with a pool of IP addresses for the DHCP clients (DHCP Pool). See the product specifications in the appendices. Do not assign static IP addresses from the DHCP pool to your LAN computers.

### 10.10.2 DNS Server Addresses

DNS (Domain Name System) maps a domain name to its corresponding IP address and vice versa. The DNS server is extremely important because without it, you must know the IP address of a computer before you can access it. The DNS server addresses you enter when you set up DHCP are passed to the client machines along with the assigned IP address and subnet mask.

There are two ways that an ISP disseminates the DNS server addresses.

- The ISP tells you the DNS server addresses, usually in the form of an information sheet, when you sign up. If your ISP gives you DNS server addresses, enter them in the **DNS Server** fields in the **DHCP Setup** screen.

- Some ISPs choose to disseminate the DNS server addresses using the DNS server extensions of IPCP (IP Control Protocol) after the connection is up. If your ISP did not give you explicit DNS servers, chances are the DNS servers are conveyed through IPCP negotiation. The Zyxel Device supports the IPCP DNS server extensions through the DNS proxy feature.

Please note that DNS proxy works only when the ISP uses the IPCP DNS server extensions. It does not mean you can leave the DNS servers out of the DHCP setup under all circumstances. If your ISP gives you explicit DNS servers, make sure that you enter their IP addresses in the **DHCP Setup** screen.

### 10.10.3 LAN TCP/IP

The Zyxel Device has built-in DHCP server capability that assigns IP addresses and DNS servers to systems that support DHCP client capability.

#### IP Address and Subnet Mask

Similar to the way houses on a street share a common street name, so too do computers on a LAN share one common network number.

Where you obtain your network number depends on your particular situation. If the ISP or your network administrator assigns you a block of registered IP addresses, follow their instructions in selecting the IP addresses and the subnet mask.

If the ISP did not explicitly give you an IP network number, then most likely you have a single user account and the ISP will assign you a dynamic IP address when the connection is established. If this is the case, it is recommended that you select a network number from 192.168.0.0 to 192.168.255.0 and you must enable the Network Address Translation (NAT) feature of the Zyxel Device. The Internet Assigned Number Authority (IANA) reserved this block of addresses specifically for private use; please do not use any other number unless you are told otherwise. Let's say you select 192.168.1.0 as the network number; which covers 254 individual addresses, from 192.168.1.1 to 192.168.1.254 (zero and 255 are reserved). In other words, the first three numbers specify the network number while the last number identifies an individual computer on that network.

Once you have decided on the network number, pick an IP address that is easy to remember, for instance, 192.168.1.1, for your Zyxel Device, but make sure that no other device on your network is using that IP address.

The subnet mask specifies the network number portion of an IP address. Your Zyxel Device will compute the subnet mask automatically based on the IP address that you entered. You do not need to change the subnet mask computed by the Zyxel Device unless you are instructed to do otherwise.

#### Private IP Addresses

Every machine on the Internet must have a unique address. If your networks are isolated from the Internet, for example, only between your two branch offices, you can assign any IP addresses to the hosts without problems. However, the Internet Assigned Numbers Authority (IANA) has reserved the following three blocks of IP addresses specifically for private networks:

- 10.0.0.0 — 10.255.255.255
- 172.16.0.0 — 172.31.255.255
- 192.168.0.0 — 192.168.255.255

You can obtain your IP address from the IANA, from an ISP or it can be assigned from a private network. If you belong to a small organization and your Internet access is through an ISP, the ISP can provide you with the Internet addresses for your local networks. On the other hand, if you are part of a much larger organization, you should consult your network administrator for the appropriate IP addresses.

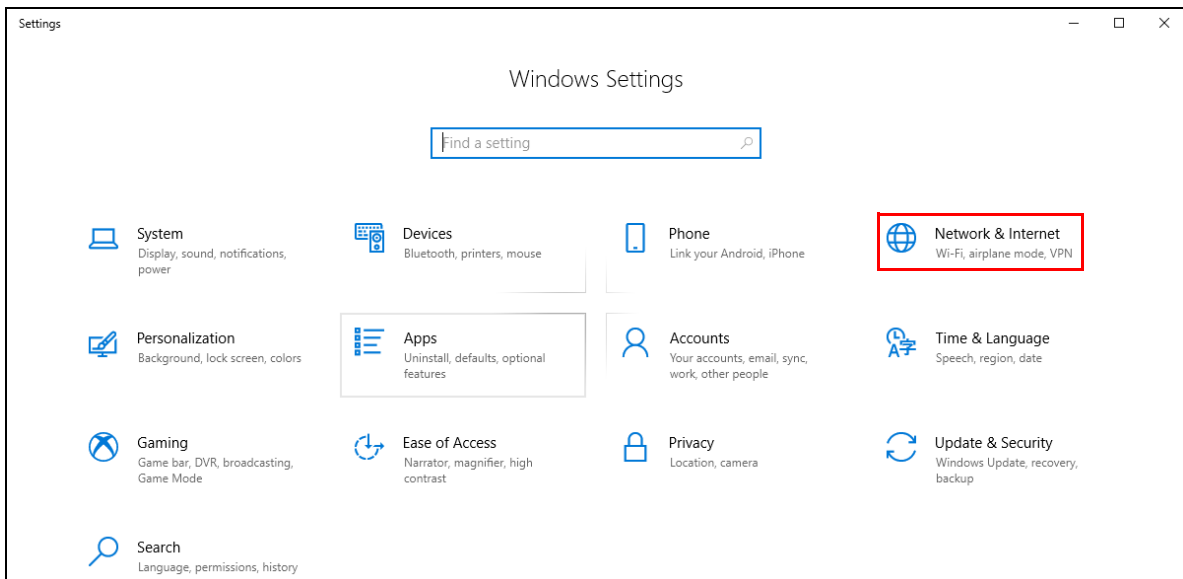
Note: Regardless of your particular situation, do not create an arbitrary IP address; always follow the guidelines above. For more information on address assignment, please refer to RFC 1597, "Address Allocation for Private Internets" and RFC 1466, "Guidelines for Management of IP Address Space".

## 10.11 Turn on UPnP in Windows 10 Example

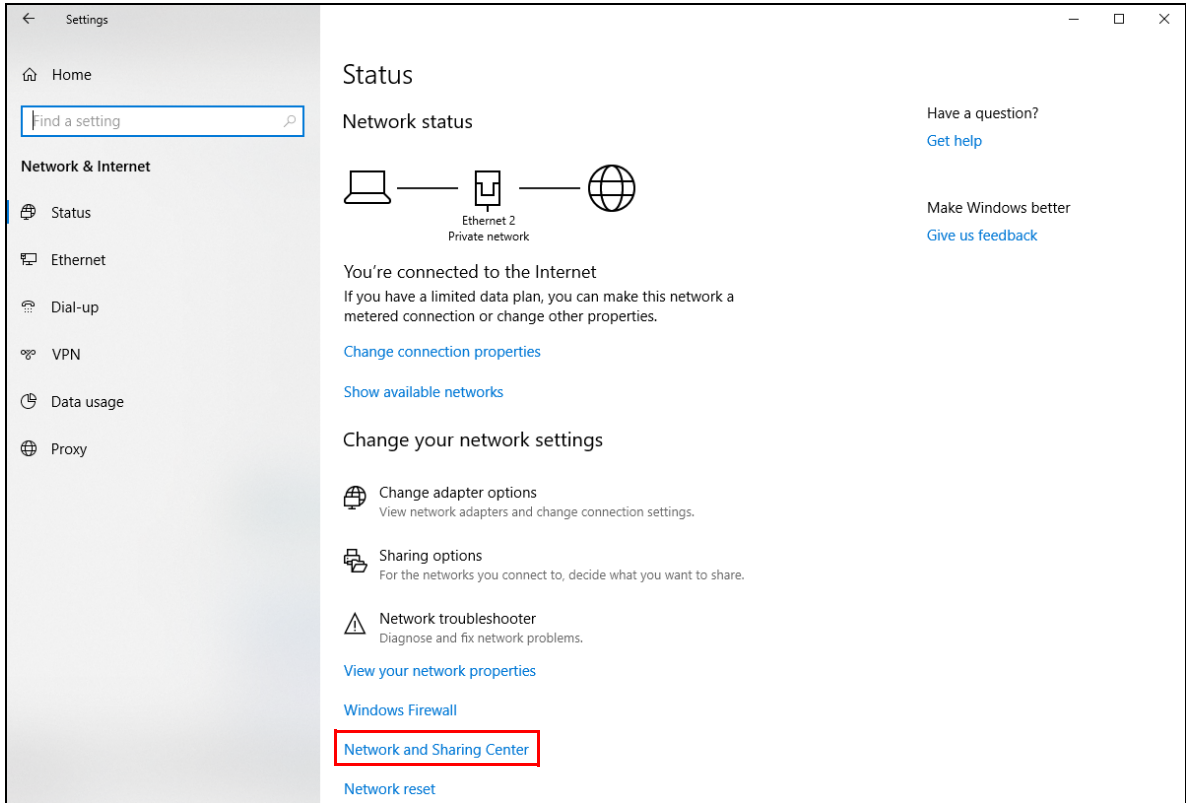
This section shows you how to use the UPnP feature in Windows 10. UPnP server is installed in Windows 10. Activate UPnP on the Zyxel Device by clicking **Network Setting > Home Networking > UPnP**.

Make sure the computer is connected to the LAN port of the Zyxel Device. Turn on your computer and the Zyxel Device.

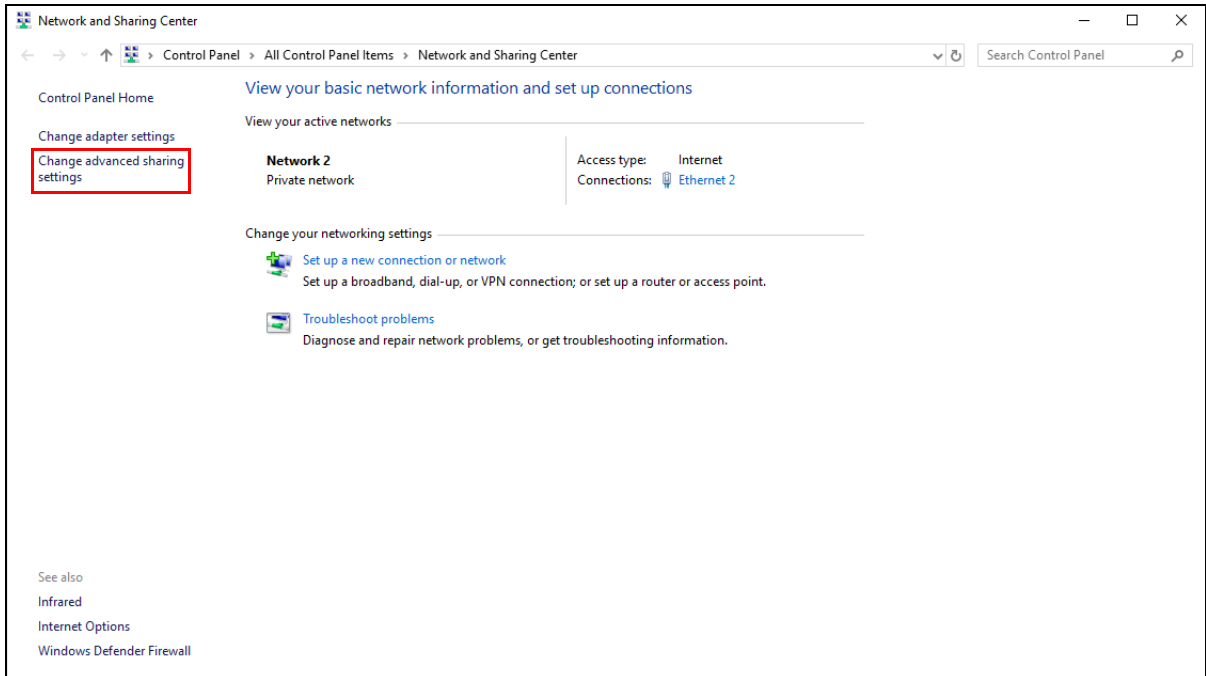
- 1 Click the start icon, **Settings** and then **Network & Internet**.



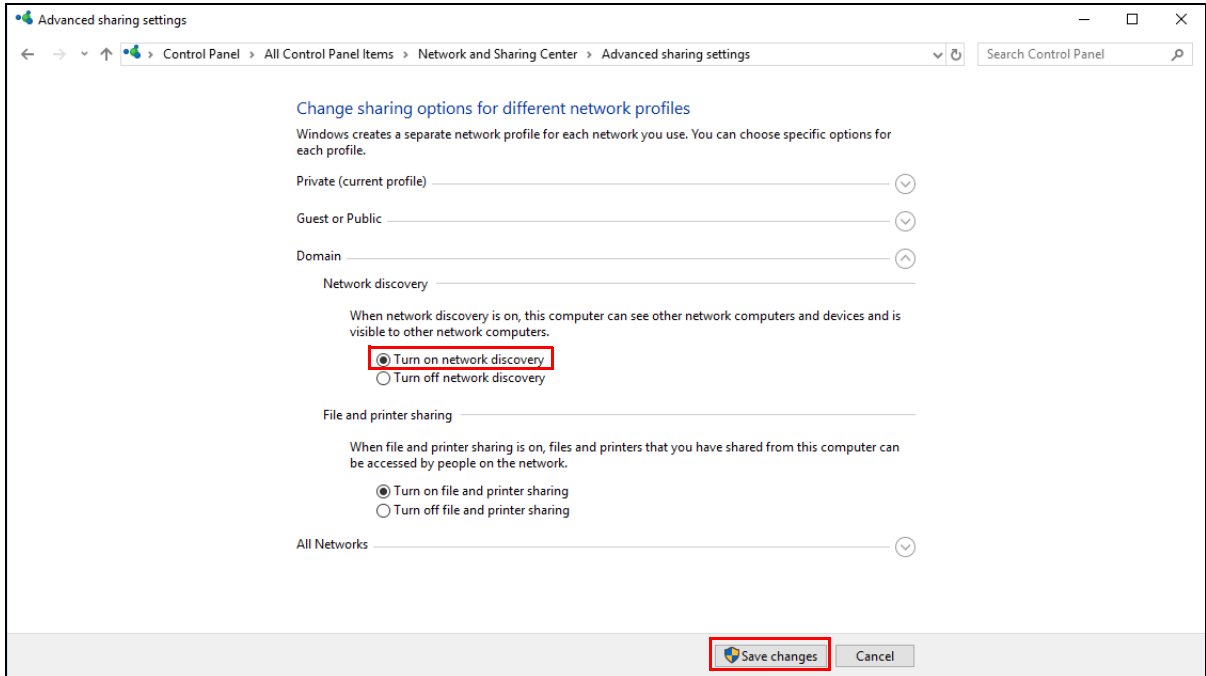
- 2 Click **Network and Sharing Center**.



**3** Click **Change advanced sharing settings**.



**4** Under **Domain**, select **Turn on network discovery** and click **Save Changes**. Network discovery allows your computer to find other computers and devices on the network and other computers on the network to find your computer. This makes it easier to share files and printers.



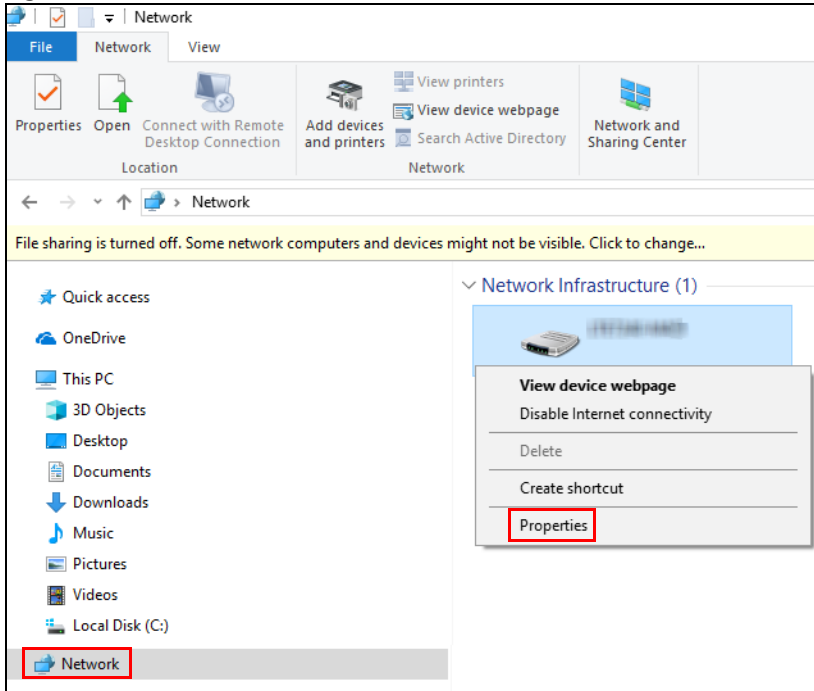
### 10.11.1 Auto-discover Your UPnP-enabled Network Device

Before you follow these steps, make sure you already have UPnP activated on the Zyxel Device and in your computer.

Make sure your computer is connected to the LAN port of the Zyxel Device.

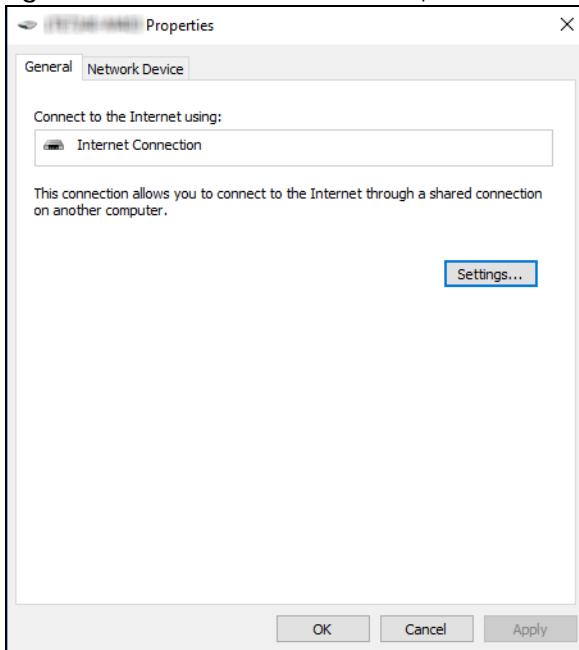
- 1 Open **File Explorer** and click **Network**.
- 2 Right-click the Zyxel Device icon and select **Properties**.

Figure 137 Network Connections

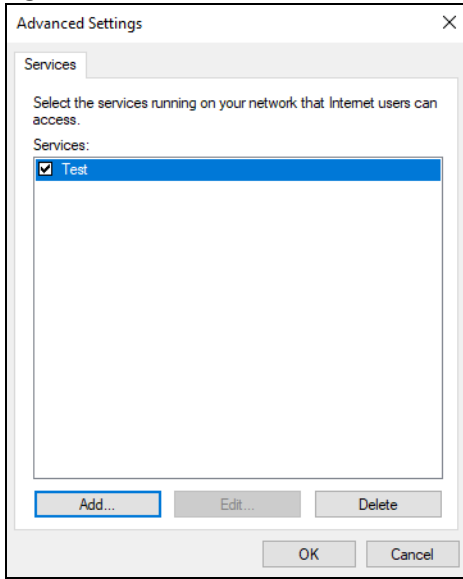
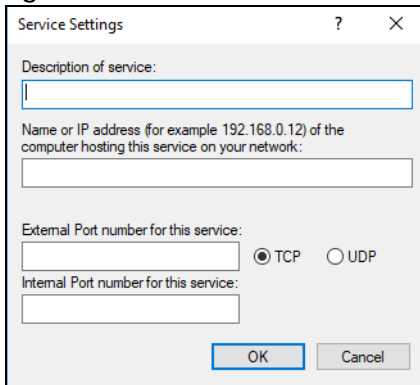


- 3 In the **Internet Connection Properties** window, click **Settings** to see port mappings.

Figure 138 Internet Connection Properties

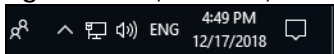


- 4 You may edit or delete the port mappings or click **Add** to manually add port mappings.

**Figure 139** Internet Connection Properties: Advanced Settings**Figure 140** Internet Connection Properties: Advanced Settings: Add

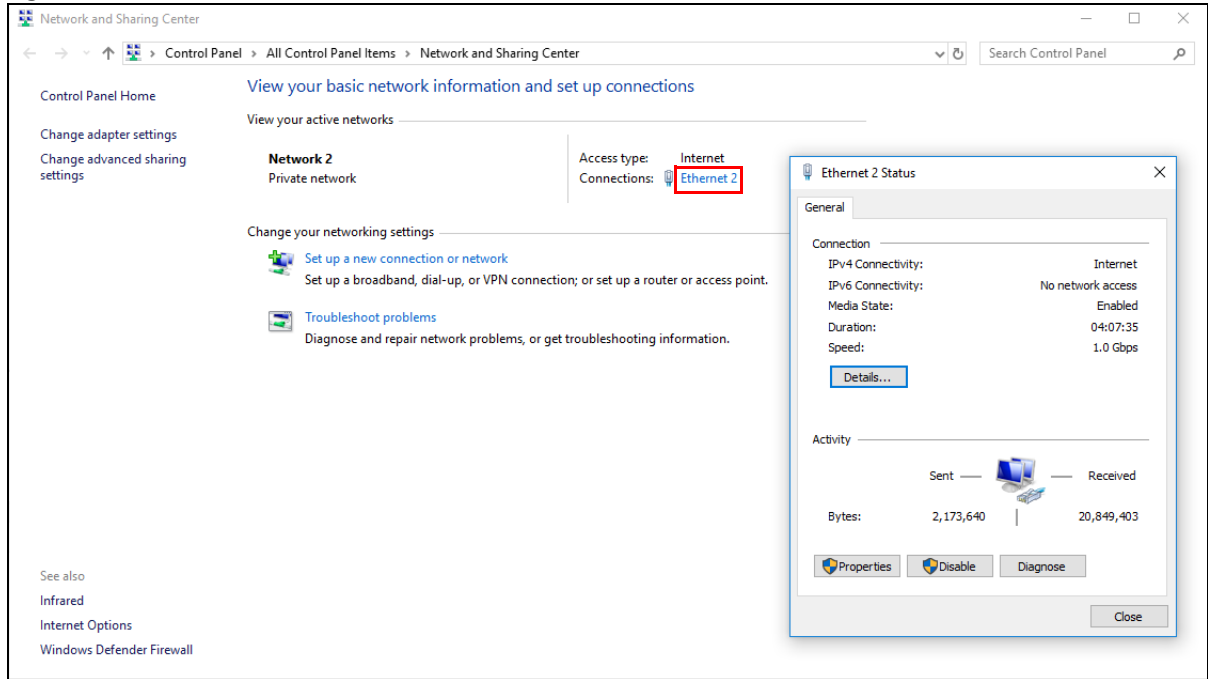
Note: When the UPnP-enabled device is disconnected from your computer, all port mappings will be deleted automatically.

- 5 Click **OK**. Check the network icon on the system tray to see your Internet connection status.

**Figure 141** System Tray Icon

- 6 To see more details about your current Internet connection status, right click the network icon in the system tray and click **Open Network & Internet settings**. Click **Network and Sharing Center** and click the **Connections**.

Figure 142 Internet Connection Status



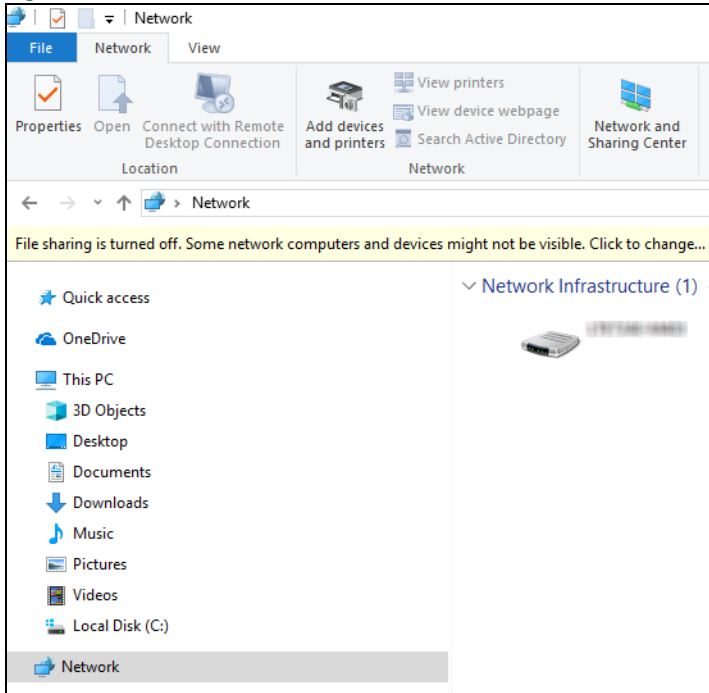
## 10.12 Web Configurator Access with UPNP in Windows 10

Follow the steps below to access the Web Configurator.

- 1 Open **File Explorer**.
- 2 Click **Network**.

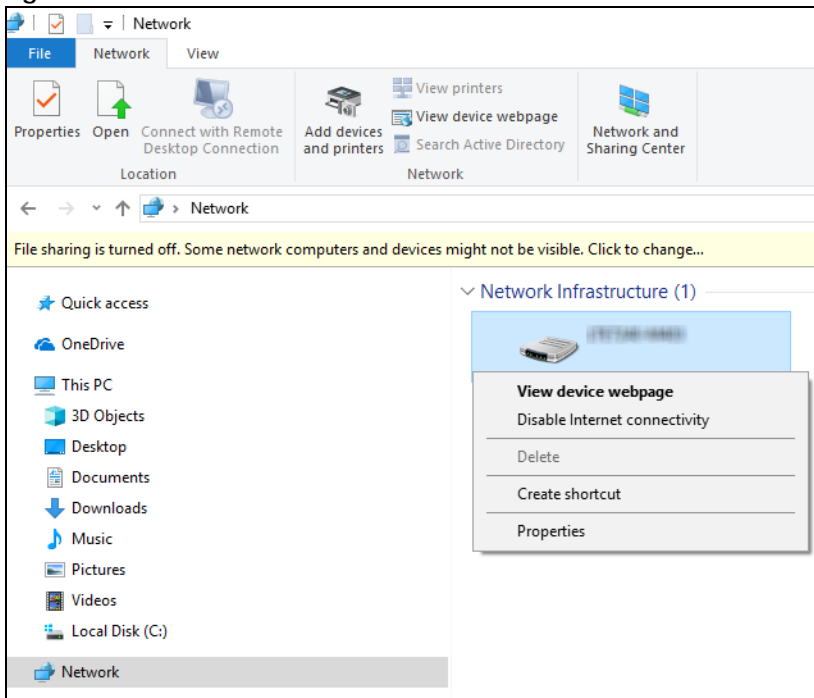


Figure 143 Network Connections



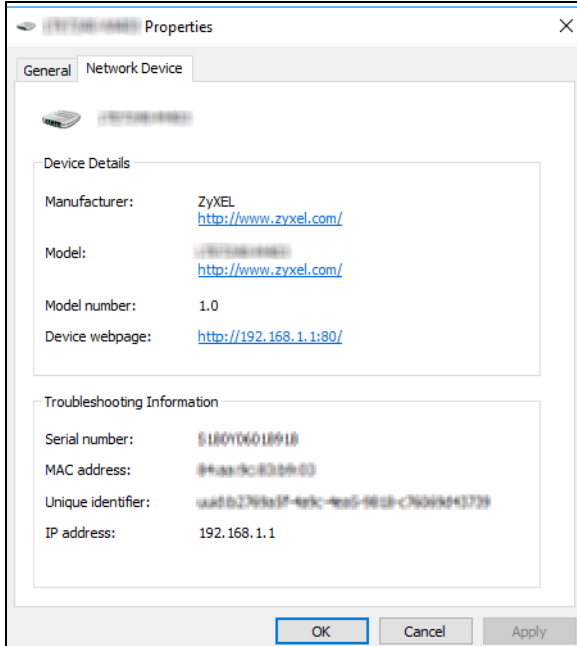
- 3 An icon with the description for each UPnP-enabled device displays under **Network Infrastructure**.
- 4 Right-click the icon for your Zyxel Device and select **View device webpage**. The Web Configurator login screen displays.

Figure 144 Network Connections: Network Infrastructure



- 5 Right-click the icon for your Zyxel Device and select **Properties**. Click the **Network Device** tab. A window displays information about the Zyxel Device.

Figure 145 Network Connections: Network Infrastructure: Properties: Example



# CHAPTER 11

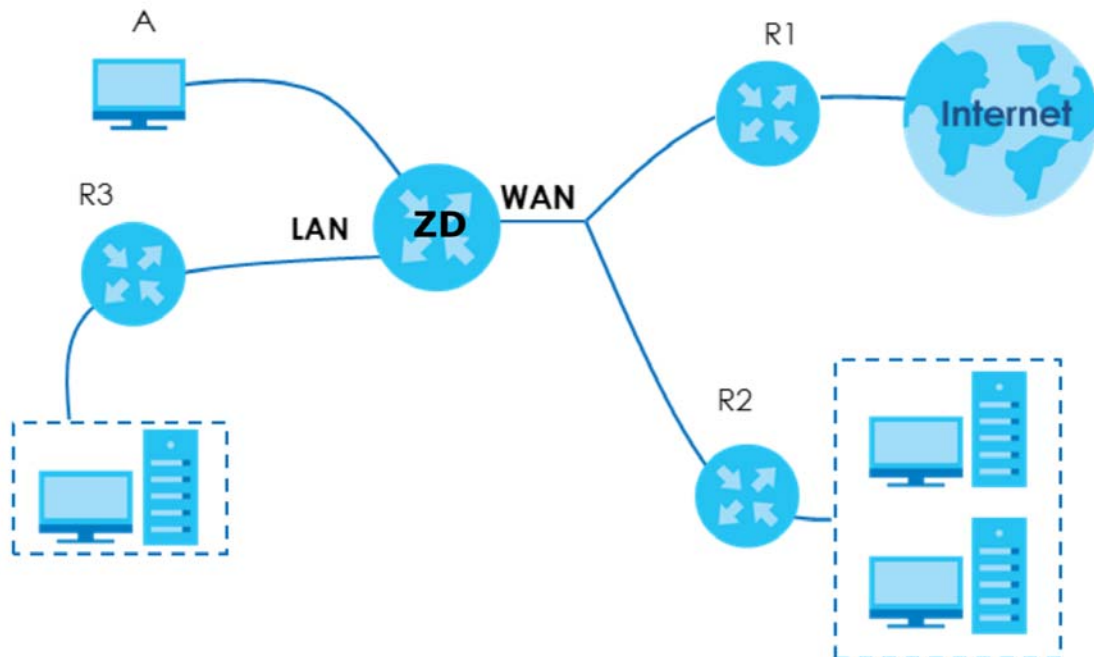
## Routing

### 11.1 Routing Overview

The Zyxel Device usually uses the default gateway to route outbound traffic from computers on the LAN to the Internet. To have the Zyxel Device send data to devices not reachable through the default gateway, use static routes.

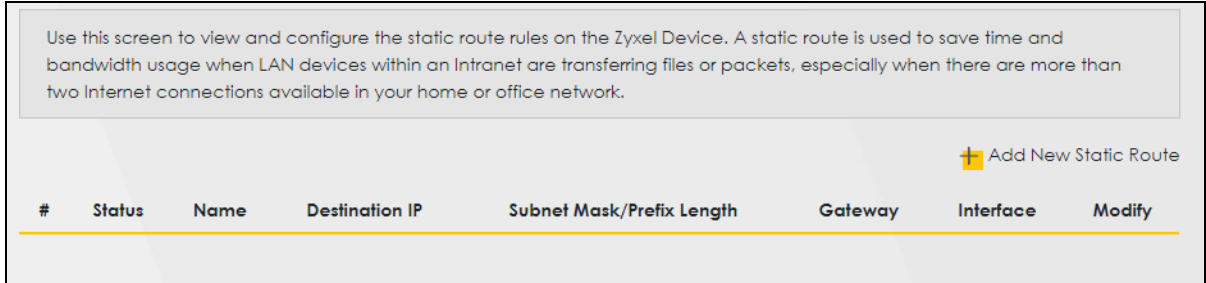
For example, the next figure shows a computer (**A**) connected to the Zyxel Device's LAN interface. The Zyxel Device routes most traffic from **A** to the Internet through the Zyxel Device's default gateway (**R1**). You create one static route to connect to services offered by your ISP behind router **R2**. You create another static route to communicate with a separate network behind a router **R3** connected to the LAN.

**Figure 146** Example of Static Routing Topology



### 11.2 Configure Static Route

Use this screen to view and configure static route rules on the Zyxel Device. A static route is used to save time and bandwidth usage when LAN devices within an Intranet are transferring files or packets, especially when there are more than two Internet connections in your home or office network. Click **Network Setting > Routing** to open the **Static Route** screen.

**Figure 147** Network Setting > Routing > Static Route

The following table describes the labels in this screen.

**Table 79** Network Setting > Routing > Static Route

LABEL	DESCRIPTION
Add New Static Route	Click this to set up a new static route on the Zyxel Device.
#	This is the number of an individual static route.
Status	This field indicates whether the rule is active (yellow bulb) or not (gray bulb).
Name	This is the name of the static route.
Destination IP	This parameter specifies the IP network address of the final destination. Routing is always based on network number.
Subnet Mask/Prefix Length	This parameter specifies the IP network subnet mask of the final destination.
Gateway	This is the IP address of the gateway. The gateway is a router or switch on the same network segment as the device's LAN or WAN port. The gateway helps forward packets to their destinations.
Interface	This is the WAN interface through which the traffic is routed.
Modify	Click the <b>Edit</b> icon to go to the screen where you can set up a static route on the Zyxel Device. Click the <b>Delete</b> icon to remove a static route from the Zyxel Device.

## 11.2.1 Add or Edit Static Route

Use this screen to add or edit a static route. Click **Add New Static Route** in the **Static Route** screen, the following screen appears. Configure the required information for a static route.

Note: The **Gateway IP Address** must be within the range of the selected interface in **Use Interface**.

**Figure 148** Network Setting > Routing > Static Route > Add New Static Route

The following table describes the labels in this screen.

**Table 80** Network Setting > Routing > Static Route > Add New Static Route

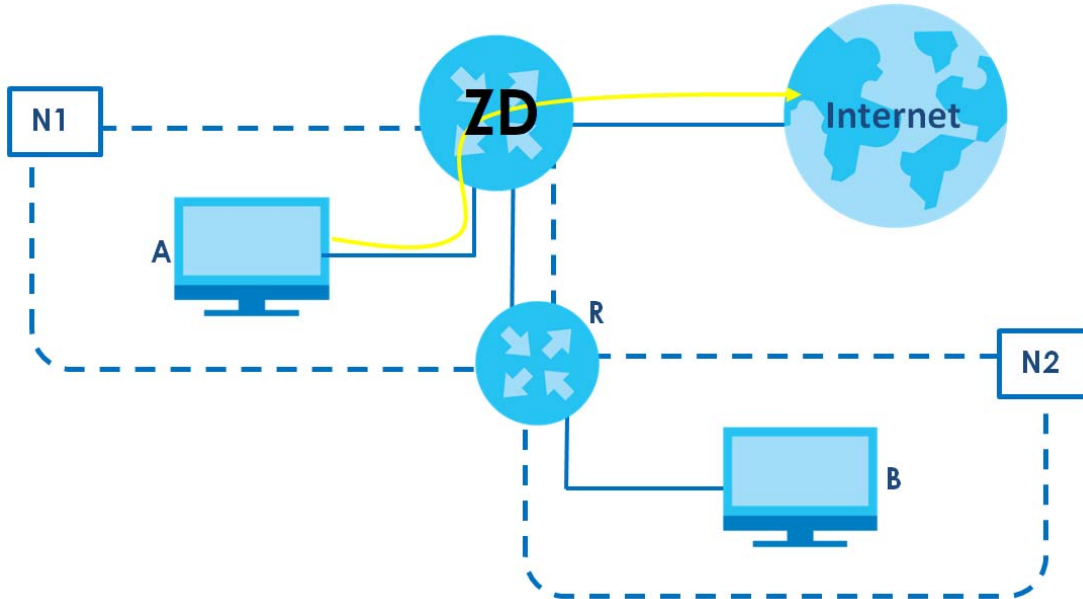
LABEL	DESCRIPTION
Active	Click this switch to activate static route. Otherwise, click to disable.
Route Name	Enter a name for your static route. You can use up to 15 printable characters except [ " ], [ ` ], [ ' ], [ < ], [ > ], [ ^ ], [ \$ ], [   ], [ & ], or [ ; ]. Spaces are allowed.
IP Type	Select between <b>IPv4</b> or <b>IPv6</b> . Compared to <b>IPv4</b> , <b>IPv6</b> (Internet Protocol version 6), is designed to enhance IP address size and features. The increase in <b>IPv6</b> address size to 128 bits (from the 32-bit <b>IPv4</b> address) allows up to 3.4 x 10 <sup>38</sup> IP addresses. The Zyxel Device can use <b>IPv4/IPv6</b> dual stack to connect to <b>IPv4</b> and <b>IPv6</b> networks, and supports <b>IPv6</b> rapid deployment (6RD).
Destination IP Address	This parameter specifies the IP network address of the final destination. Routing is always based on network number. If you need to specify a route to a single host, use a subnet mask of 255.255.255.255 in the subnet mask field to force the network number to be identical to the host ID.
Subnet Mask	If you are using IPv4 and need to specify a route to a single host, use a subnet mask of 255.255.255.255 in the subnet mask field to force the network number to be identical to the host ID. Enter the IP subnet mask here.
Use Gateway IP Address	The gateway is a router or switch on the same network segment as the device's LAN or WAN port. The gateway helps forward packets to their destinations.  Click this switch to enable or disable the gateway IP address. When the switch goes to the right, the function is enabled. Otherwise, it is not.
Gateway IP Address	Enter the IP address of the gateway.
User Interface	Select the WAN interface you want to use for this static route.
OK	Click this to save your changes.
Cancel	Click this to exit this screen without saving.

### 11.2.1.1 An Example of Adding a Static Route

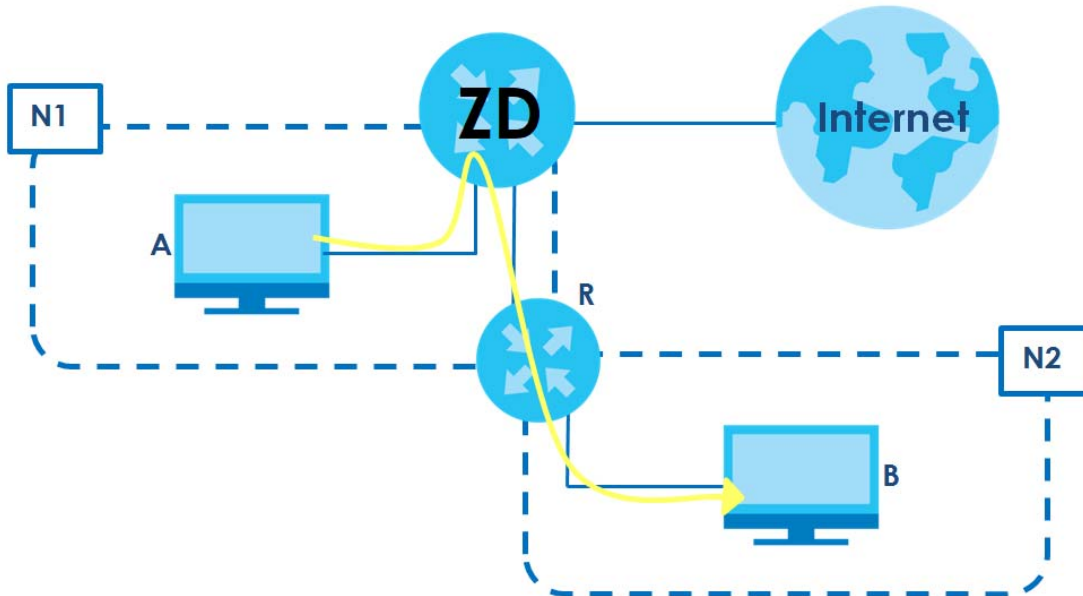
In order to extend your Intranet and control traffic flowing directions, you may connect a router to the Zyxel Device's LAN. The router may be used to separate two department networks. This tutorial shows how to configure a static routing rule for two network routings.

In the following figure, router **R** is connected to the Zyxel Device's LAN. **R** connects to two networks, **N1** (192.168.1.x/24) and **N2** (192.168.10.x/24). If you want to send traffic from computer **A** (in **N1** network) to

computer **B** (in **N2** network), the traffic is sent to the Zyxel Device's WAN default gateway by default. In this case, **B** will never receive the traffic.



You need to specify a static routing rule on the Zyxel Device to specify **R** as the router in charge of forwarding traffic to **N2**. In this case, the Zyxel Device routes traffic from **A** to **R** and then **R** routes the traffic to **B**.



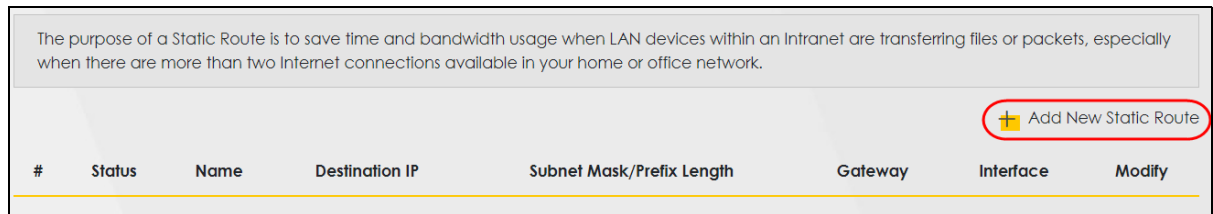
This tutorial uses the following example IP settings:

Table 81 IP Settings in this Tutorial

DEVICE / COMPUTER	IP ADDRESS
The Zyxel Device's WAN	172.16.1.1
The Zyxel Device's LAN	192.168.1.1
IP Type	IPv4
Use Interface	Default
<b>A</b>	192.168.1.34
<b>R's N1</b>	192.168.1.253
<b>R's N2</b>	192.168.10.2
<b>B</b>	192.168.10.33

To configure a static route to route traffic from **N1** to **N2**:

- 1 Log into the Zyxel Device's Web Configurator.
- 2 Click **Network Setting > Routing**.
- 3 Click **Add new Static Route** in the **Static Route** screen.



- 4 Configure the **Static Route Setup** screen using the following settings:
  - Click the **Active** button to enable this static route. When the switch goes to the right, the function is enabled. Enter the **Route Name** as **R**.
  - Set **IP Type** to **IPv4**.
  - Enter the **Destination IP Address** **192.168.10.1** and **IP Subnet Mask** **255.255.255.0** for the destination, **N2**.
  - Click the **Use Gateway IP Address** button to enable this function. When the switch goes to the right, the function is enabled. Enter **192.168.1.253** (**R's N1** address) in the **Gateway IP Address** field.
  - Select **Default** as the **Use Interface**.
  - Click **OK**.

Now **B** should be able to receive traffic from **A**. You may need to additionally configure **B's** firewall settings to allow specific traffic to pass through.

## 11.3 DNS Route

Use this screen to view and configure DNS routes on the Zyxel Device. A DNS route entry defines a policy for the Zyxel Device to forward a particular DNS query to a specific WAN interface. Click **Network Setting > Routing > DNS Route** to open the **DNS Route** screen.

**Figure 149** Network Setting > Routing > DNS Route

The following table describes the labels in this screen.

**Table 82** Network Setting > Routing > DNS Route

LABEL	DESCRIPTION
Add New DNS Route	Click this to create a new entry.
#	This is the number of an individual DNS route.



Table 82 Network Setting &gt; Routing &gt; DNS Route (continued)

LABEL	DESCRIPTION
Status	This field indicates whether the rule is active (yellow bulb) or not (gray bulb).
Domain Name	This is the domain name to which the DNS route applies.
WAN Interface	This is the WAN interface through which the matched DNS request is routed.
Subnet Mask	This parameter specifies the IP network subnet mask.
Modify	Click the <b>Edit</b> icon to configure a DNS route on the Zyxel Device. Click the <b>Delete</b> icon to remove a DNS route from the Zyxel Device.

### 11.3.1 Add or Edit DNS Route

You can manually add the Zyxel Device's DNS route entry. Click **Add New DNS Route** in the **DNS Route** screen, use this screen to configure the required information for a DNS route.

Figure 150 Network Setting &gt; Routing &gt; DNS Route &gt; Add New DNS Route

The following table describes the labels in this screen.

Table 83 Network Setting &gt; Routing &gt; DNS Route &gt; Add New DNS Route

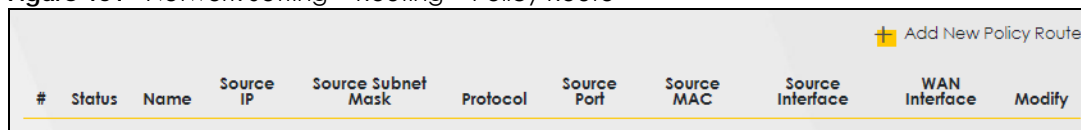
LABEL	DESCRIPTION
Active	Enable DNS route in your Zyxel Device.
Domain Name	Enter the domain name you want to resolve. You can use up to 64 alphanumeric (0-9, a-z, A-Z) characters with hyphens [ - ] and periods [ . ].  You can use the wildcard character, an "*" (asterisk) as the left most part of a domain name, such as *.example.com. The Zyxel Device forwards DNS queries for any domain name ending in example.com to the WAN interface specified in this route.
Subnet Mask	Enter the subnet mask of the network for which to use the DNS route in dotted decimal notation, for example 255.255.255.255.
WAN Interface	Select a WAN interface through which the matched DNS query is sent. You must have the WAN interfaces already configured in the <b>Broadband</b> screen.
OK	Click this to save your changes.
Cancel	Click this to exit this screen without saving.

## 11.4 Policy Route

By default, the Zyxel Device routes packets based on the shortest path to the destination address. Policy routes allow you to override the default behavior and route packets based on other criteria, such as the source address. For example, you can use policy-based routing to direct traffic from specific users through specific connections or distribute traffic across multiple paths for load sharing. Policy-based routing is applied to outgoing packets before the default routing rules are applied.

The **Policy Route** screen let you view and configure routing policies on the Zyxel Device. Click **Network Setting > Routing > Policy Route** to open the following screen.

**Figure 151** Network Setting > Routing > Policy Route



#	Status	Name	Source IP	Source Subnet Mask	Protocol	Source Port	Source MAC	Source Interface	WAN Interface	Modify
---	--------	------	-----------	--------------------	----------	-------------	------------	------------------	---------------	--------

The following table describes the labels in this screen.

**Table 84** Network Setting > Routing > Policy Route

LABEL	DESCRIPTION
Add New Policy Route	Click this to create a new policy forwarding rule.
#	This is the index number of the entry.
Status	This field displays whether the DNS route is active or not. A yellow bulb signifies that this DNS route is active. A gray bulb signifies that this DNS route is not active.
Name	This is the name of the rule.
Source IP	This is the source IP address.
Source Subnet Mask	This is the source subnet mask address.
Protocol	This is the transport layer protocol.
Source Port	This is the source port number.
Source MAC	This is the source MAC address.
Source Interface	This is the interface from which the matched traffic is sent.
WAN Interface	This is the WAN interface through which the traffic is routed.
Modify	Click the <b>Edit</b> icon to edit this policy. Click the <b>Delete</b> icon to remove a policy from the Zyxel Device. A window displays asking you to confirm that you want to delete the policy.

### 11.4.1 Add or Edit Policy Route

Click **Add New Policy Route** in the **Policy Route** screen or click the **Edit** icon next to a policy. Use this screen to configure the required information for a policy route.

**Figure 152** Network Setting > Routing > Policy Route: Add or Edit

The following table describes the labels in this screen.

**Table 85** Network Setting > Routing > Policy Route: Add or Edit

LABEL	DESCRIPTION
Active	Click this switch to activate this policy route. Otherwise, click to disable.
Route Name	Enter a descriptive name of this policy route. You can use up to 15 printable characters except [ " ], [ ` ], [ ' ], [ < ], [ > ], [ ^ ], [ \$ ], [   ], [ & ], or [ ; ]. Spaces are allowed.
Source IP Address	Enter the source IP address.
Source Subnet Mask	Enter the source subnet mask address.
Protocol	Select the transport layer protocol ( <b>TCP</b> , <b>UDP</b> , or <b>None</b> ).
Source Port	Enter the source port number.
Source MAC	Enter the source MAC address.
Source Interface (example: br0 or LAN1 – LAN4)	Enter the name of the interface from which the matched traffic is sent.
WAN Interface	Select a WAN interface through which the traffic is sent. You must have the WAN interfaces already configured in the <b>Broadband</b> screens.
Cancel	Click <b>Cancel</b> to exit this screen without saving.
OK	Click <b>OK</b> to save your changes.

## 11.5 RIP Overview

Routing Information Protocol (RIP, RFC 1058 and RFC 1389) allows the Zyxel Device to exchange routing information with other routers. To activate RIP for the WAN interface, select the supported RIP version and operation.

### 11.5.1 RIP

Click **Network Setting > Routing > RIP** to open the **RIP** screen. Select the desired RIP version and operation by clicking the check box. To stop RIP on the WAN interface, clear the check box. Click the **Apply** button to start or stop RIP and save the configuration.

**Figure 153** Network Setting > Routing > RIP

The screenshot shows the 'Routing' configuration page with the 'RIP' tab selected. Below the tabs is a descriptive text box: 'Routing Information Protocol (RIP, RFC 1058 and RFC 1389) allows a device to exchange routing information with other routers.' Below this is a table with the following data:

#	Interface	Version	Operation	Enable	Disable Default Gateway
1	ADSL	RIPv2	Active	<input type="checkbox"/>	<input type="checkbox"/>
2	VDSL	RIPv2	Active	<input type="checkbox"/>	<input type="checkbox"/>
3	ETHWAN	RIPv2	Active	<input type="checkbox"/>	<input type="checkbox"/>

At the bottom of the screen are 'Cancel' and 'Apply' buttons.

The following table describes the labels in this screen.

**Table 86** Network Setting > Routing > RIP

LABEL	DESCRIPTION
#	This is the index of the interface in which the RIP setting is used.
Interface	This is the name of the interface in which the RIP setting is used.
Version	The RIP version controls the format and the broadcasting method of the RIP packets that the Zyxel Device sends (it recognizes both formats when receiving). <b>RIPv1</b> is universally supported but <b>RIPv2</b> carries more information. <b>RIPv1</b> is probably adequate for most networks, unless you have an unusual network topology. When set to <b>Both</b> , the Zyxel Device will broadcast its routing table periodically and incorporate the RIP information that it receives
Operation	Select <b>Passive</b> to have the Zyxel Device update the routing table based on the RIP packets received from neighbors but not advertise its route information to other routers in this interface. Select <b>Active</b> to have the Zyxel Device advertise its route information and also listen for routing updates from neighboring routers.
Enable	Select the check box to activate the settings.
Disable Default Gateway	Select the check box to set the Zyxel Device to not send the route information to the default gateway.
Cancel	Click <b>Cancel</b> to exit this screen without saving.
Apply	Click <b>Apply</b> to save your changes back to the Zyxel Device.

# CHAPTER 12

## Quality of Service (QoS)

### 12.1 QoS Overview

Quality of Service (QoS) refers to both a network's ability to deliver data with minimum delay, and the networking methods used to control the use of bandwidth. Without QoS, all traffic data is equally likely to be dropped when the network is congested. This can cause a reduction in network performance and make the network inadequate for time-critical applications such as video-on-demand.

Configure QoS on the Zyxel Device to group and prioritize application traffic and fine-tune network performance. Setting up QoS involves these steps:

- 1 Configure classifiers to sort traffic into different flows.
- 2 Assign priority and define actions to be performed for a classified traffic flow.

The Zyxel Device assigns each packet a priority and then queues the packet accordingly. Packets assigned a high priority are processed more quickly than those with low priority if there is congestion, allowing time-sensitive applications to flow more smoothly. Time-sensitive applications include both those that require a low level of latency (delay) and a low level of jitter (variations in delay) such as Voice over IP (VoIP) or Internet gaming, and those for which jitter alone is a problem such as Internet radio or streaming video. There are eight priority levels, with 1 having the highest priority.

This chapter contains information about configuring QoS and editing classifiers.

#### 12.1.1 What You Can Do in this Chapter

- The **General** screen lets you enable or disable QoS and set the upstream bandwidth ([Section 12.3 on page 311](#)).
- The **Queue Setup** screen lets you configure QoS queue assignment ([Section 12.4 on page 313](#)).
- The **Classification Setup** screen lets you add, edit or delete QoS classifiers ([Section 12.5 on page 315](#)).
- The **Shaper Setup** screen limits outgoing traffic transmission rate on the selected interface ([Section 12.6 on page 321](#)).
- The **Policer Setup** screen lets you control incoming traffic transmission rate and bursts ([Section 12.7 on page 322](#)).
- The **Monitor** screen lets you use any available port to access any available service from a remote WAN device ([Section 12.8 on page 325](#)).

### 12.2 What You Need to Know

The following terms and concepts may help as you read through this chapter.

## QoS versus CoS

QoS is used to prioritize source-to-destination traffic flows. All packets in the same flow are given the same priority. CoS (class of service) is a way of managing traffic in a network by grouping similar types of traffic together and treating each type as a class. You can use CoS to give different priorities to different packet types.

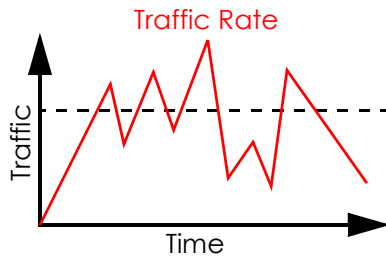
CoS technologies include IEEE 802.1p layer 2 tagging and DiffServ (Differentiated Services or DS). IEEE 802.1p tagging makes use of 3 bits in the packet header, while DiffServ is a new protocol and defines a new DS field, which replaces the eight-bit ToS (Type of Service) field in the IP header.

## Tagging and Marking

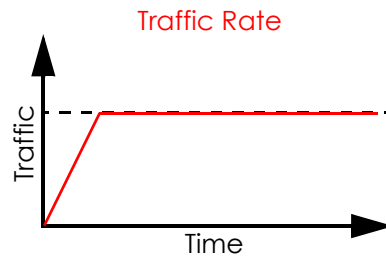
In a QoS class, you can configure whether to add or change the DSCP (DiffServ Code Point) value, IEEE 802.1p priority level and VLAN ID number in a matched packet. When the packet passes through a compatible network, the networking device, such as a backbone switch, can provide specific treatment or service based on the tag or marker.

## Traffic Shaping

Bursty traffic may cause network congestion. Traffic shaping regulates packets to be transmitted with a pre-configured data transmission rate using buffers (or queues). Your Zyxel Device uses the Token Bucket algorithm to allow a certain amount of large bursts while keeping a limit at the average rate.



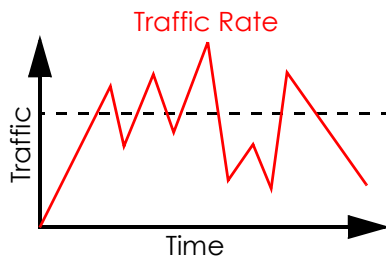
(Before Traffic Shaping)



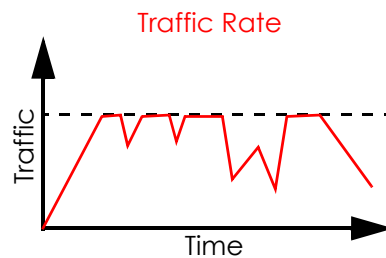
(After Traffic Shaping)

## Traffic Policing

Traffic policing is the limiting of the input or output transmission rate of a class of traffic on the basis of user-defined criteria. Traffic policing methods measure traffic flows against user-defined criteria and identify it as either conforming, exceeding or violating the criteria.



(Before Traffic Policing)



(After Traffic Policing)

The Zyxel Device supports three incoming traffic metering algorithms: Token Bucket Filter (TBF), Single Rate Two Color Marker (srTCM), and Two Rate Two Color Marker (trTCM). You can specify actions which are performed on the colored packets. See [Section 12.9 on page 326](#) for more information on each metering algorithm.

### Strictly Priority

Strictly Priority (SP) services queues based on priority only. As traffic comes into the Switch, traffic on the highest priority queue, Q7 is transmitted first. When that queue empties, traffic on the next highest priority queue, Q6 is transmitted until Q6 empties, and then traffic is transmitted on Q5 and so on. If higher priority queues never empty, then traffic on lower priority queues never gets sent. SP does not automatically adapt to changing network requirements.

### Weighted Round Robin Schedule (WRR)

Round Robin Scheduling services queues on a rotating basis and is activated only when a port has more traffic than it can handle. A queue is given an amount of bandwidth irrespective of the incoming traffic on that port. This queue then moves to the back of the list. The next queue is given an equal amount of bandwidth, and then moves to the end of the list; and so on, depending on the number of queues being used. This works in a looping fashion until a queue is empty.

Weighted Round Robin Scheduling (WRR) uses the same algorithm as round robin scheduling, but services queues based on their priority and queue weight (the number you configure in the queue **Weight** field) rather than a fixed amount of bandwidth. WRR is activated only when a port has more traffic than it can handle. Queues with larger weights get more service than queues with smaller weights. This queuing mechanism is highly efficient in that it divides any available bandwidth across the different traffic queues and returns to queues that have not yet emptied.

## 12.3 Quality of Service General Settings

Use this screen to enable or disable QoS and set the upstream bandwidth or assign traffic priority. See [Section 12.1 on page 309](#) for more information.

When one of the following situations happens, the current WAN linkup rate will be used instead:

- 1 **WAN Managed Upstream Bandwidth** is set to 0
- 2 **WAN Managed Upstream Bandwidth** is empty
- 3 **WAN Managed Upstream Bandwidth** is higher than the current WAN interface linkup rate

Note: Manually defined QoS is ignored when **Upstream Traffic Priority** is selected.

Note: **Upstream Traffic Priority** automatically assigns a traffic priority level based on the selected criteria.

Note: To have your QoS settings configured in other **QoS** screens take effect, select **None** in the **Upstream Traffic Priority Assigned by** field.

Click **Network Setting > QoS > General** to open the screen as shown next.

Figure 154 Network &gt; QoS &gt; General

### QoS

**General** Queue Setup Classification Setup Shaper Setup Policer Setup

Use this screen to enable or disable QoS and set the upstream bandwidth or assign traffic priority.

When one of the following situations happens, the current WAN linkup rate will be used instead:

1. **WAN Managed Upstream Bandwidth** is set to 0
2. **WAN Managed Upstream Bandwidth** is empty
3. **WAN Managed Upstream Bandwidth** is higher than the current WAN interface linkup rate

QoS

WAN Managed Upstream Bandwidth  (kbps)

Upstream Traffic Priority Assigned by

Note

(1) Manually defined QoS is ignored when **Upstream Traffic Priority** is selected.

(2) **Upstream Traffic Priority** automatically assigns a traffic priority level based on the selected criteria.

(3) To have your QoS settings configured in other **QoS** screens take effect, select **None** in the **Upstream Traffic Priority Assigned by** field.

Cancel **Apply**

The following table describes the labels in this screen.

Table 87 Network Setting &gt; QoS &gt; General

LABEL	DESCRIPTION
QoS	Click this switch to enable QoS to improve your network performance.
WAN Managed Upstream Bandwidth	<p>Enter the amount of upstream bandwidth for the WAN interfaces that you want to allocate using QoS.</p> <p>The recommendation is to set this speed to match the interfaces' actual transmission speed. For example, set the WAN interfaces' speed to 100000 kbps if your Internet connection has an upstream transmission speed of 100 Mbps.</p> <p>You can also set this number lower than the interfaces' actual transmission speed. This will cause the Zyxel Device to not use some of the interfaces' available bandwidth.</p> <p>If you leave this field blank, the Zyxel Device automatically sets this number to be 95% of the WAN interfaces' actual upstream transmission speed.</p>
Upstream Traffic Priority Assigned by	<p>Select how the Zyxel Device assigns priorities to various upstream traffic flows.</p> <ul style="list-style-type: none"> <li>• <b>None:</b> Disables auto priority mapping and has the Zyxel Device put packets into the queues according to your classification rules. Traffic which does not match any of the classification rules is mapped into the default queue with the lowest priority.</li> <li>• <b>Ethernet Priority:</b> Automatically assign priority based on the IEEE 802.1p priority level.</li> <li>• <b>IP Precedence:</b> Automatically assign priority based on the first three bits of the TOS field in the IP header.</li> <li>• <b>Packet Length:</b> Automatically assign priority based on the packet size. Smaller packets get higher priority since control, signaling, VoIP, Internet gaming, or other real-time packets are usually small while larger packets are usually best effort data packets like file transfers.</li> </ul>
Cancel	Click <b>Cancel</b> to restore your previously saved settings.
Apply	Click <b>Apply</b> to save your changes.



## 12.4 Queue Setup

Click **Network Setting > QoS > Queue Setup** to open the screen as shown next.

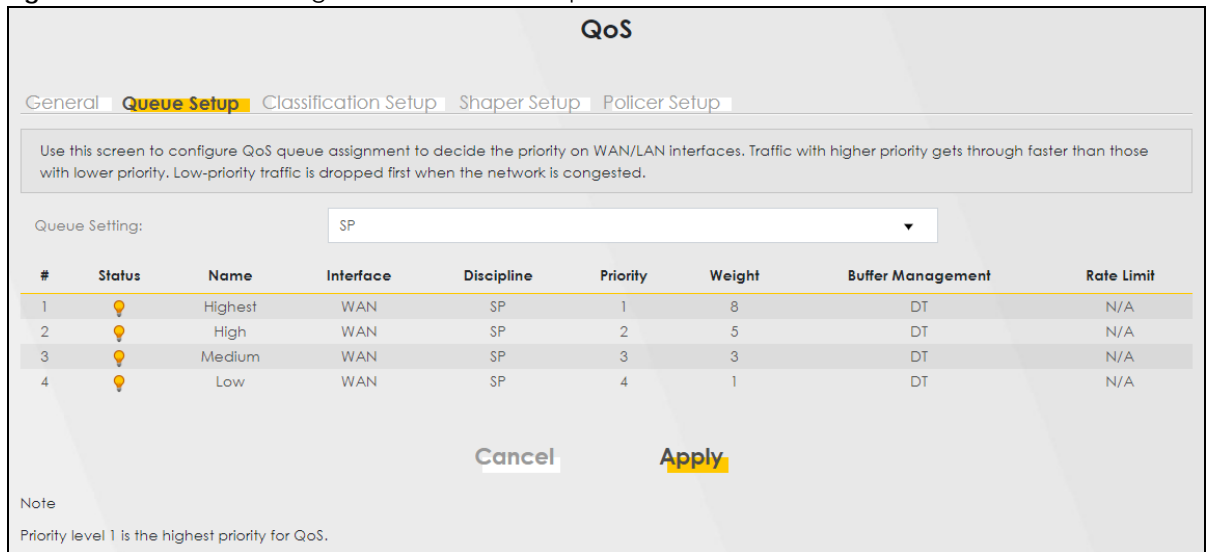
Use this screen to configure QoS queue assignment to decide the priority on WAN or LAN interfaces. Traffic with higher priority gets through faster than those with lower priority. Low-priority traffic is dropped first when the network is congested.

Note: Configure the priority level for a QoS queue from 1 to 8. The smaller the number in the **Priority** column, the higher the priority.

Note: The corresponding classifiers will be removed automatically if a queue is deleted.

Note: Rate limit 0 means there is no rate limit on a queue.

**Figure 155** Network Setting > QoS > Queue Setup



**QoS**

General **Queue Setup** Classification Setup Shaper Setup Policer Setup

Use this screen to configure QoS queue assignment to decide the priority on WAN/LAN interfaces. Traffic with higher priority gets through faster than those with lower priority. Low-priority traffic is dropped first when the network is congested.

Queue Setting:

#	Status	Name	Interface	Discipline	Priority	Weight	Buffer Management	Rate Limit
1		Highest	WAN	SP	1	8	DT	N/A
2		High	WAN	SP	2	5	DT	N/A
3		Medium	WAN	SP	3	3	DT	N/A
4		Low	WAN	SP	4	1	DT	N/A

Note  
Priority level 1 is the highest priority for QoS.

The following table describes the labels in this screen.

**Table 88** Network Setting > QoS > Queue Setup

LABEL	DESCRIPTION
Add New Queue	Click this to create a new queue entry.
Queue Setting	Select between <b>SP</b> (Strict Priority), <b>SP+WRR</b> , or <b>WRR</b> (Weighted Round Robin). <b>SP</b> scheduling singles out the highest priority queue and ensures all queued traffic in this queue is transmitted before servicing the lower priority queues. <b>WRR</b> scheduling services queues on a rotating basis based on their queue weight (the number you configure in the queue <b>Weight</b> field. Queues with larger weights get more service than queues with smaller weights. If you choose <b>SP+WRR</b> , the first and second queue will be <b>SP</b> , and the third and fourth queue will be <b>WRR</b> .
#	This is the index number of the entry.
Status	This field displays whether the queue is active or not. A yellow bulb signifies that this queue is active. A gray bulb signifies that this queue is not active.
Name	This shows the descriptive name of this queue.
Interface	This shows the name of the Zyxel Device's interface through which traffic in this queue passes.

Table 88 Network Setting &gt; QoS &gt; Queue Setup (continued)

LABEL	DESCRIPTION
Discipline	<p>This shows the discipline of the queue. The discipline is changed according to the option chosen in <b>Queue Setting</b>. If you choose <b>SP</b>, the discipline will be SP. If you choose <b>SP+WRR</b>, the discipline of the first and second queue will be SP, and the third and fourth queue will be WRR. If you choose <b>WRR</b>, the discipline will be WRR. Strict Priority scheduling services the remaining queues using WRR.</p> <p>WRR scheduling services queues on a rotating basis based on their queue weight (the number you configure in the queue Weight field). Queues with larger weights get more service than queues with smaller weights.</p> <p>Note: Queue weights can only be changed when Weighted Round Robin is selected.</p>
Priority	This shows the priority of this queue. The lower the number, the higher the priority level.
Weight	This shows the weight of this queue.
Buffer Management	<p>This shows the queue management algorithm used for this queue.</p> <p>Queue management algorithms determine how the Zyxel Device should handle packets when it receives too many (network congestion).</p>
Rate Limit	This shows the maximum transmission rate allowed for traffic on this queue.
Modify	<p>Click the <b>Edit</b> icon to edit the queue.</p> <p>Click the <b>Delete</b> icon to delete an existing queue. Note that subsequent rules move up by one when you take this action.</p>

## 12.4.1 Add a QoS Queue

Click **Add New Queue** or the **Edit** icon in the **Queue Setup** screen to configure a queue.

Figure 156 Network Setting &gt; QoS &gt; Queue Setup &gt; Add New Queue/Edit

The screenshot shows the 'Add New Queue' dialog box. It includes the following fields and controls:

- Active:** A toggle switch currently turned off.
- Name:** An empty text input field.
- Interface:** A dropdown menu with 'WAN' selected.
- Priority:** A dropdown menu with '1 (highest)' selected.
- Weight:** A dropdown menu with '1' selected.
- Buffer Management:** A dropdown menu with 'Drop Tail(DT)' selected.
- Rate Limit:** An empty text input field with '(kbps)' to its right.
- Buttons:** 'Cancel' and 'OK' buttons at the bottom.

The following table describes the labels in this screen.

Table 89 Network Setting > QoS > Queue Setup > Add New Queue/Edit

LABEL	DESCRIPTION
Active	Click this switch to enable the queue.
Name	Enter a descriptive name for this queue. You can use up to 32 printable characters except [ " ], [ ` ], [ ' ], [ < ], [ > ], [ ^ ], [ \$ ], [   ], [ & ], or [ ; ]. Spaces are allowed.
Interface	Select the interface to which this queue is applied. This field is read-only if you are editing the queue.
Priority	Select the priority level (from 1 to 8) of this queue.  The smaller the number, the higher the priority level. Traffic assigned to higher priority queues gets through faster while traffic in lower priority queues is dropped if the network is congested.
Weight	Select the weight (from 1 to 8) of this queue.  If two queues have the same priority level, the Zyxel Device divides the bandwidth across the queues according to their weights. Queues with larger weights get more bandwidth than queues with smaller weights.
Buffer Management	This field displays <b>Drop Tail (DT)</b> . <b>Drop Tail (DT)</b> is a simple queue management algorithm that allows the Zyxel Device buffer to accept as many packets as it can until it is full. Once the buffer is full, new packets that arrive are dropped until there is space in the buffer again (packets are transmitted out of it).
Rate Limit	Specify the maximum transmission rate (in Kbps) allowed for traffic on this queue. If you enter 0 here, this means there's no rate limit on this queue.
Cancel	Click <b>Cancel</b> to exit this screen without saving.
OK	Click <b>OK</b> to save your changes.

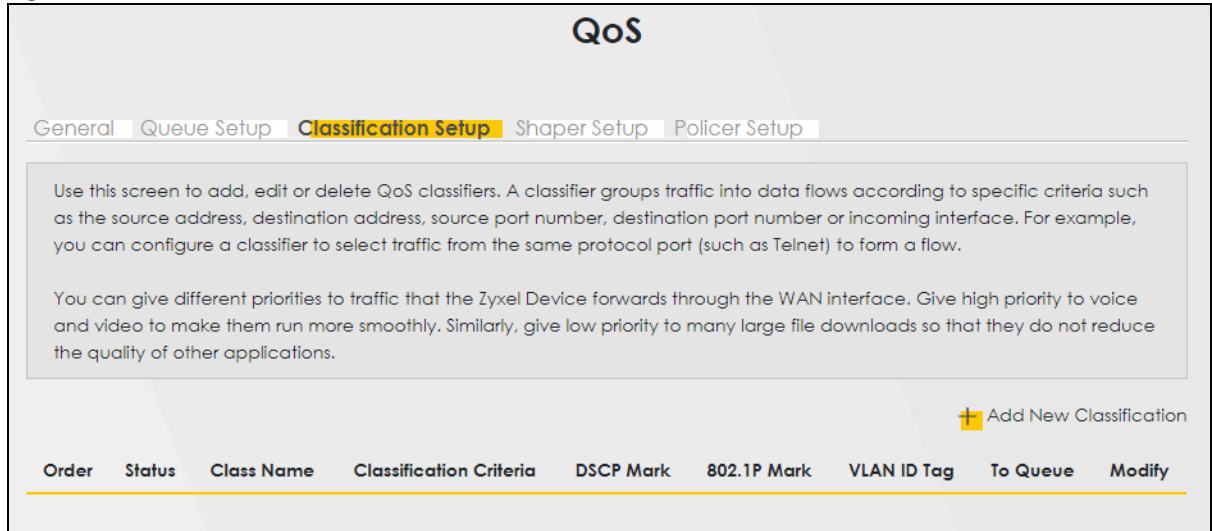
## 12.5 QoS Classification Setup

Use this screen to add, edit or delete QoS classifiers. A classifier groups traffic into data flows according to specific criteria such as the source address, destination address, source port number, destination port number or incoming interface. For example, you can configure a classifier to select traffic from the same protocol port (such as Telnet) to form a flow.

You can give different priorities to traffic that the Zyxel Device forwards through the WAN interface. Give high priority to voice and video to make them run more smoothly. Similarly, give low priority to many large file downloads so that they do not reduce the quality of other applications.

Click **Network Setting > QoS > Classification Setup** to open the following screen.

Figure 157 Network Setting &gt; QoS &gt; Classification Setup



The following table describes the labels in this screen.

Table 90 Network Setting &gt; QoS &gt; Classification Setup

LABEL	DESCRIPTION
Add New Classification	Click this to create a new classifier.
Order	This is the index number of the entry. The classifiers are applied in order of their numbering.
Status	This field displays whether the classifier is active or not. A yellow bulb signifies that this classifier is active. A gray bulb signifies that this classifier is not active.
Class Name	This is the name of the classifier.
Classification Criteria	This shows criteria specified in this classifier, for example the interface from which traffic of this class should come and the source MAC address of traffic that matches this classifier.
DSCP Mark	This is the DSCP number added to traffic of this classifier.
802.1P Mark	This is the IEEE 802.1p priority level assigned to traffic of this classifier.
VLAN ID Tag	This is the VLAN ID number assigned to traffic of this classifier.
To Queue	This is the name of the queue in which traffic of this classifier is put.
Modify	Click the <b>Edit</b> icon to edit the classifier. Click the <b>Delete</b> icon to delete an existing classifier. Note that subsequent rules move up by one when you take this action.

## 12.5.1 Add or Edit QoS Class

Click **Add New Classification** in the **Classification Setup** screen or the **Edit** icon next to a classifier to open the following screen.

Figure 158 Network Setting &gt; QoS &gt; Classification Setup &gt; Add New Classification/Edit: Step1

### Add New Classification

Please follow the guidance through step 1~5 to configure a QoS rule

**Step1: Class Configuration**

Active

Class Name

Classification Order

Figure 159 Network Setting &gt; QoS &gt; Classification Setup &gt; Add New Classification/Edit: Step2

**Step2: Criteria Configuration**

Use the configurations below to specify the characteristics of a data flow needed to be managed by this QoS rule

**Basic**

From Interface

Ether Type

**Source**

Address  Subnet Mask   Exclude

Port Range  ~   Exclude

MAC  MAC Mask   Exclude

**Destination**

Address  Subnet Mask   Exclude

Port Range  ~   Exclude

MAC  MAC Mask   Exclude

**Others**

Service   Exclude

IP protocol    Exclude

DHCP   Exclude

IP Packet Length  ~   Exclude

DSCP  (0~63)  Exclude

802.1P   Exclude

VLAN ID  (1~4094)  Exclude

TCP ACK  Exclude

**Figure 160** Network Setting > QoS > Classification Setup > Add New Classification/Edit: Step3

**Step3: Packet Modification**

The content of the packet can be modified by applying the following settings

DSCP Mark  (0~63)

VLAN ID Tag  0 (1~4094)

802.1P Mark

**Figure 161** Network Setting > QoS > Classification Setup > Add New Classification/Edit: Step4

**Step4: Class Routing**

This module can route a packet to a certain interface according to the class setting

Forward To Interface

**Figure 162** Network Setting > QoS > Classification Setup > Add New Classification/Edit: Step5

**Step5: Outgoing Queue Selection**

Outgoing queue decides the priority of the traffic and how traffic should be shaped in the WAN interface.

To Queue Index

The following table describes the labels in this screen.

Table 91 Network Setting &gt; QoS &gt; Classification Setup &gt; Add New Classification/Edit

LABEL	DESCRIPTION
Step1: Class Configuration	
Active	Click this switch to enable the classifier.
Class Name	Enter a descriptive name for this class. You can use up to 32 printable characters except [ " ], [ ` ], [ ' ], [ < ], [ > ], [ ^ ], [ \$ ], [   ], [ & ], or [ ; ]. Spaces are allowed.
Classification Order	Select an existing number for where you want to put this classifier to move the classifier to the number you selected after clicking <b>Apply</b> . Select <b>Last</b> to put this rule in the back of the classifier list.
Step2: Criteria Configuration	
Basic	
From Interface	If you want to classify the traffic by an ingress interface, select an interface from the <b>From Interface</b> drop-down list box.
Ether Type	Select a predefined application to configure a class for the matched traffic. Traffic will be classified with the Ether Type of Ethernet frames. Ether Type is a field in an Ethernet frame used to identify the protocol encapsulated in the frame. Select <b>NA</b> to specify traffic that does not belong to any Ether type. If you select <b>IP</b> , you also need to configure source or destination, IP address, DHCP options, DSCP value or the protocol type. If you select <b>IPv6</b> , you also need to configure source or destination, IPv6 address, DSCP value or the protocol type. If you select <b>802.1Q</b> , you can configure an 802.1p priority level.
Source	

Table 91 Network Setting &gt; QoS &gt; Classification Setup &gt; Add New Classification/Edit (continued)

LABEL	DESCRIPTION
Address	Select the check box and enter the source IP address in dotted decimal notation. A blank source IP address means any source IP address.
Subnet Mask	This field is available only when you select <b>IP</b> in the <b>Ether Type</b> field. Enter the source subnet mask.
Prefix Length	This field is available only when you select <b>IPv6</b> in the <b>Ether Type</b> field. Enter the source prefix length.
Port Range	If you select <b>TCP</b> or <b>UDP</b> in the <b>IP Protocol</b> field, select the check box and enter the port numbers of the source.
MAC	Select the check box and enter the source MAC address of the packet.
MAC Mask	Enter the mask for the specified MAC address to determine which bits a packet's MAC address should match.  Enter "f" for each bit of the specified source MAC address that the traffic's MAC address should match. Enter "0" for the bits of the matched traffic's MAC address, which can be of any hexadecimal characters. For example, if you set the MAC address to 00:13:49:00:00:00 and the mask to ff:ff:ff:00:00:00, a packet with a MAC address of 00:13:49:12:34:56 matches this criteria.
Exclude	Select this option to exclude the packets that match the specified criteria from this classifier.
Destination	
Address	Select the check box and enter the source IP address in dotted decimal notation. A blank source IP address means any source IP address.
Subnet Mask	This field is available only when you select <b>IP</b> in the <b>Ether Type</b> field. Enter the source subnet mask.
Prefix Length	This field is available only when you select <b>IPv6</b> in the <b>Ether Type</b> field. Enter the source prefix length.  See the IPv6 Appendix for more IPv6 information.
Port Range	If you select <b>TCP</b> or <b>UDP</b> in the <b>IP Protocol</b> field, select the check box and enter the port numbers of the source.
MAC	Select the check box and enter the source MAC address of the packet.
MAC Mask	Enter the mask for the specified MAC address to determine which bits a packet's MAC address should match.  Enter "f" for each bit of the specified source MAC address that the traffic's MAC address should match. Enter "0" for the bits of the matched traffic's MAC address, which can be of any hexadecimal characters. For example, if you set the MAC address to 00:13:49:00:00:00 and the mask to ff:ff:ff:00:00:00, a packet with a MAC address of 00:13:49:12:34:56 matches this criteria.
Exclude	Select this option to exclude the packets that match the specified criteria from this classifier.
Others	
Service	This field is available only when you select <b>IP</b> or <b>IPv6</b> in the <b>Ether Type</b> field.  This field simplifies classifier configuration by allowing you to select a predefined application. When you select a predefined application, you do not configure the rest of the filter fields.
IP Protocol	This field is available only when you select <b>IP</b> or <b>IPv6</b> in the <b>Ether Type</b> field.  Select this option and select the protocol (service type) from <b>TCP</b> , <b>UDP</b> , <b>ICMP</b> or <b>IGMP</b> . If you select <b>User defined</b> , enter the protocol (service type) number.

Table 91 Network Setting &gt; QoS &gt; Classification Setup &gt; Add New Classification/Edit (continued)

LABEL	DESCRIPTION
DHCP	<p>This field is available only when you select <b>IP</b> in the <b>Ether Type</b> field.</p> <p>Select this option and select a DHCP option.</p> <p>If you select <b>Vendor Class ID (DHCP Option 60)</b>, enter the Vendor Class Identifier (Option 60) of the matched traffic, such as the type of the hardware or firmware.</p> <p>If you select <b>Client ID (DHCP Option 61)</b>, enter the Identity Association Identifier (IAD Option 61) of the matched traffic, such as the MAC address of the device.</p> <p>If you select <b>User Class ID (DHCP Option 77)</b>, enter a string that identifies the user's category or application type in the matched DHCP packets.</p> <p>If you select <b>Vendor Specific Info (DHCP Option 125)</b>, enter the vendor specific information of the matched traffic, such as the product class, model name, and serial number of the device.</p>
IP Packet Length	<p>This field is available only when you select <b>IP</b> in the <b>Ether Type</b> field.</p> <p>Select this option and enter the minimum and maximum packet length (from 46 to 1500) in the fields provided.</p>
DSCP	<p>This field is available only when you select <b>IP</b> or <b>IPv6</b> in the <b>Ether Type</b> field.</p> <p>Select this option and specify a DSCP (DiffServ Code Point) number between 0 and 63 in the field provided.</p>
802.1P	<p>This field is available only when you select <b>802.1Q</b> in the <b>Ether Type</b> field.</p> <p>Select this option and select a priority level (between 0 and 7) from the drop-down list box. "0" is the lowest priority level and "7" is the highest.</p>
VLAN ID	<p>This field is available only when you select <b>802.1Q</b> in the <b>Ether Type</b> field.</p> <p>Select this option and specify a VLAN ID number.</p>
TCP ACK	<p>This field is available only when you select <b>IP</b> in the <b>Ether Type</b> field.</p> <p>If you select this option, the matched TCP packets must contain the ACK (Acknowledge) flag.</p>
Exclude	<p>Select this option to exclude the packets that match the specified criteria from this classifier.</p>
Step3: Packet Modification	
DSCP Mark	<p>This field is available only when you select <b>IP</b> in the <b>Ether Type</b> field.</p> <p>If you select <b>Remark</b>, enter a DSCP value with which the Zyxel Device replaces the DSCP field in the packets.</p> <p>If you select <b>Unchange</b>, the Zyxel Device keep the DSCP field in the packets.</p>
VLAN ID Tag	<p>If you select <b>Remark</b>, enter a VLAN ID number with which the Zyxel Device replaces the VLAN ID of the frames.</p> <p>If you select <b>Remove</b>, the Zyxel Device deletes the VLAN ID of the frames before forwarding them out.</p> <p>If you select <b>Add</b>, the Zyxel Device treat all matched traffic untagged and add a second VLAN ID.</p> <p>If you select <b>Unchange</b>, the Zyxel Device keep the VLAN ID in the packets.</p>
802.1P Mark	<p>Select a priority level with which the Zyxel Device replaces the IEEE 802.1p priority field in the packets.</p> <p>If you select <b>Unchange</b>, the Zyxel Device keep the 802.1p priority field in the packets.</p>
Step4: Class Routing	
Forward to Interface	<p>Select a WAN interface through which traffic of this class will be forwarded out. If you select <b>Unchange</b>, the Zyxel Device forward traffic of this class according to the default routing table.</p>
Step5: Outgoing Queue Selection	



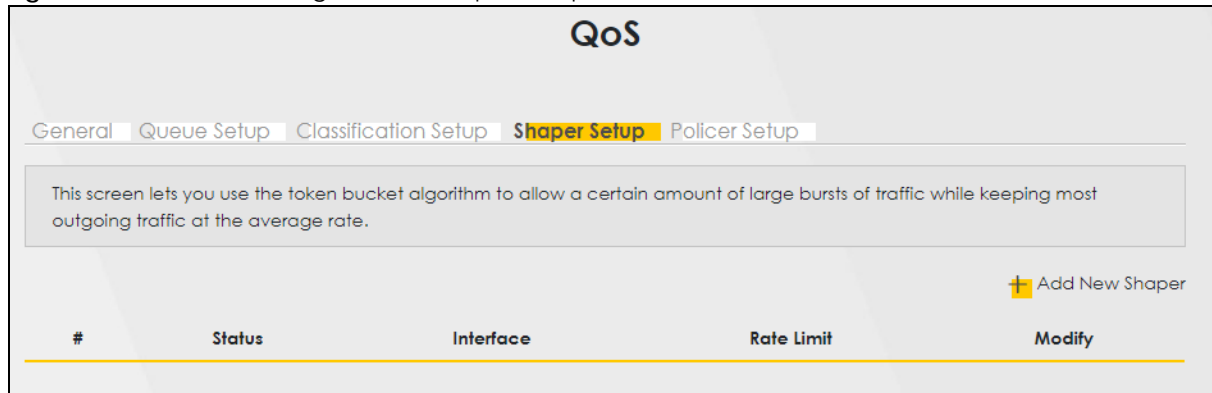
Table 91 Network Setting &gt; QoS &gt; Classification Setup &gt; Add New Classification/Edit (continued)

LABEL	DESCRIPTION
To Queue Index	Select a queue that applies to this class. You should have configured a queue in the <b>Queue Setup</b> screen already.
Cancel	Click <b>Cancel</b> to exit this screen without saving any changes.
OK	Click <b>OK</b> to save your changes.

## 12.6 QoS Shaper Setup

This screen lets you use the token bucket algorithm to allow a certain amount of large bursts of traffic while keeping most outgoing traffic at the average rate. Click **Network Setting > QoS > Shaper Setup**. The screen appears as shown.

Figure 163 Network Setting &gt; QoS &gt; Shaper Setup



The following table describes the labels in this screen.

Table 92 Network Setting &gt; QoS &gt; Shaper Setup

LABEL	DESCRIPTION
Add New Shaper	Click this to create a new entry.
#	This is the index number of the entry.
Status	This field displays whether the shaper is active or not. A yellow bulb signifies that this policer is active. A gray bulb signifies that this shaper is not active.
Interface	This shows the name of the Zyxel Device's interface through which traffic in this shaper applies.
Rate Limit	This shows the average rate limit of traffic bursts for this shaper.
Modify	Click the <b>Edit</b> icon to edit the shaper. Click the <b>Delete</b> icon to delete an existing shaper. Note that subsequent rules move up by one when you take this action.

## 12.6.1 Add or Edit a QoS Shaper

Click **Add New Shaper** in the **Shaper Setup** screen or the **Edit** icon next to a shaper to show the following screen.

**Figure 164** Network Setting > QoS > Shaper Setup > Add New Shaper/Edit

The following table describes the labels in this screen.

**Table 93** Network Setting > QoS > Shaper Setup > Add New Shaper/Edit

LABEL	DESCRIPTION
Active	Click this switch to enable the shaper.
Interface	Select a Zyxel Device's interface through which traffic in this shaper applies.
Rate Limit	Enter the average rate limit of traffic bursts for this shaper.
Cancel	Click <b>Cancel</b> to exit this screen without saving any changes.
OK	Click <b>OK</b> to save your changes.

## 12.7 QoS Policer Setup

Use this screen to view QoS policers that allow you to limit the transmission rate of incoming traffic and apply actions, such as drop, pass, or modify, to the DSCP value of matched traffic. Click **Network Setting > QoS > Policer Setup**. The screen appears as shown.

**Figure 165** Network Setting > QoS > Policer Setup

The following table describes the labels in this screen.

Table 94 Network Setting > QoS > Policer Setup

LABEL	DESCRIPTION
Add New Policer	Click this to create a new entry.
#	This is the index number of the entry.
Status	This field displays whether the policer is active or not. A yellow bulb signifies that this policer is active. A gray bulb signifies that this policer is not active.
Name	This field displays the descriptive name of this policer.
Regulated Classes	This field displays the name of a QoS classifier
Meter Type	This field displays the type of QoS metering algorithm used in this policer.
Rule	These are the rates and burst sizes against which the policer checks the traffic of the member QoS classes.
Action	This shows how the policer has the Zyxel Device treat different types of traffic belonging to the policer's member QoS classes.
Modify	Click the <b>Edit</b> icon to edit the policer.  Click the <b>Delete</b> icon to delete an existing policer. Note that subsequent rules move up by one when you take this action.

## 12.7.1 Add or Edit a QoS Policer

Click **Add New Policer** in the **Policer Setup** screen or the **Edit** icon next to a policer to show the following screen.

Figure 166 Network Setting > QoS > Policer Setup > Add New Policer/Edit

The following table describes the labels in this screen.

Table 95 Network Setting > QoS > Policer Setup > Add New Policer/Edit

LABEL	DESCRIPTION
Active	Click this switch to enable the policer.
Name	Enter a descriptive name for this policer. You can use up to 16 printable characters except [ " ], [ ` ], [ ' ], [ < ], [ > ], [ ^ ], [ \$ ], [   ], [ & ], or [ ; ]. Spaces are allowed.
Meter Type	This shows the traffic metering algorithm used in this policer.  The <b>Simple Token Bucket</b> algorithm uses tokens in a bucket to control when traffic can be transmitted. Each token represents one byte. The algorithm allows bursts of up to <i>b</i> bytes which is also the bucket size.  The <b>Single Rate Three Color</b> Marker (srTCM) is based on the token bucket filter and identifies packets by comparing them to the Committed Information Rate (CIR), the Committed Burst Size (CBS) and the Excess Burst Size (EBS).  The <b>Two Rate Three Color</b> Marker (trTCM) is based on the token bucket filter and identifies packets by comparing them to the Committed Information Rate (CIR) and the Peak Information Rate (PIR).
Committed Rate	Specify the committed rate. When the incoming traffic rate of the member QoS classes is less than the committed rate, the device applies the conforming action to the traffic.

Table 95 Network Setting &gt; QoS &gt; Policer Setup &gt; Add New Policer/Edit (continued)

LABEL	DESCRIPTION
Committed Burst Size	Specify the committed burst size for packet bursts. This must be equal to or less than the peak burst size (two rate three color) or excess burst size (single rate three color) if it is also configured.  This is the maximum size of the (first) token bucket in a traffic metering algorithm.
Excess Burst Size	Specify the additional amount of bytes that are admitted at the committed rate besides the committed burst size.  This is the maximum size of the second token bucket in the srTCM.  This field is only available when you select <b>Single Rate Three Color</b> in the <b>Meter Type</b> field.
Peak Rate	Specify the maximum rate at which packets are admitted to the network.  The peak rate should be greater than or equal to the committed rate. This is to specify how many bytes of tokens are added to the second bucket every second in the trTCM.  This field is only available when you select <b>Two Rate Three Color</b> in the <b>Meter Type</b> field.
Peak Burst Size	Specify the maximum amount of bytes that are admitted at the committed rate.  This is the maximum size of the second token bucket in the trTCM.  This field is only available when you select <b>Two Rate Three Color</b> in the <b>Meter Type</b> field.
Conforming Action	Specify what the Zyxel Device does for packets within the committed rate and burst size (green-marked packets). <ul style="list-style-type: none"> <li>• <b>Pass:</b> Send the packets without modification.</li> <li>• <b>DSCP Mark:</b> Change the DSCP mark value of the packets. Enter the DSCP mark value to use.</li> </ul>
Partial Conforming Action	Specify the action that the Zyxel Device takes on yellow-marked packets.  Select <b>Pass</b> to forward the packets.  Select <b>Drop</b> to discard the packets.  Select <b>DSCP Mark</b> to assign a specified DSCP number (between 0 and 63) to the packets and forward them. The packets are dropped if there is congestion on the network.  This field is only available when you select <b>Single/Two Rate Three Color</b> in the <b>Meter Type</b> field.
Non-Conforming Action	Specify what the Zyxel Device does for packets that exceed the excess burst size or peak rate and burst size (red-marked packets). <ul style="list-style-type: none"> <li>• <b>Drop:</b> Discard the packets.</li> <li>• <b>DSCP Mark:</b> Change the DSCP mark value of the packets. Enter the DSCP mark value to use. The packets may be dropped if there is congestion on the network.</li> </ul>
Regulated Classes Member Setting	
Available Class	Select a QoS classifier to apply this QoS policer to traffic that matches the QoS classifier.
Selected Class	Highlight a QoS classifier in the <b>Available Class</b> box and use the > button to move it to the <b>Selected Class</b> box.  To remove a QoS classifier from the <b>Selected Class</b> box, select it and use the < button.
Cancel	Click <b>Cancel</b> to exit this screen without saving any changes.
OK	Click <b>OK</b> to save your changes.

## 12.8 QoS Monitor

To view the Zyxel Device's QoS packet statistics, click **Network Setting > QoS > Monitor**. The screen appears as shown.

**Figure 167** Network Setting > QoS > Monitor

Use this screen to view QoS statistics for WAN/LAN interfaces and the status of the Queue setup.

Refresh Interval :

**Interface Monitor**

#	Name	Pass Rate(bps)	Drop Rate (bps)
1	WAN	0	0
2	LAN	0	0

**Queue Monitor**

#	Name	Pass Rate(bps)	Drop Rate (bps)
---	------	----------------	-----------------

The following table describes the labels in this screen.

**Table 96** Network Setting > QoS > Monitor

LABEL	DESCRIPTION
Refresh Interval	Select how often you want the Zyxel Device to update this screen. Select <b>None</b> to stop refreshing
Interface Monitor	
#	This is the index number of the entry.
Name	This shows the name of the interface on the Zyxel Device.
Pass Rate (bps)	This shows how many packets forwarded to this interface are transmitted successfully.
Drop Rate (bps)	This shows how many packets forwarded to this interface are dropped.
Queue Monitor	
#	This is the index number of the entry.
Name	This shows the name of the queue.
Pass Rate (bps)	This shows how many packets assigned to this queue are transmitted successfully.
Drop Rate (bps)	This shows how many packets assigned to this queue are dropped.

## 12.9 Technical Reference

The following section contains additional technical information about the Zyxel Device features described in this chapter.

### IEEE 802.1Q Tag

The IEEE 802.1Q standard defines an explicit VLAN tag in the MAC header to identify the VLAN membership of a frame across bridges. A VLAN tag includes the 12-bit VLAN ID and 3-bit user priority. The VLAN ID associates a frame with a specific VLAN and provides the information that devices need to process the frame across the network.

IEEE 802.1p specifies the user priority field and defines up to eight separate traffic types. The following table describes the traffic types defined in the IEEE 802.1d standard (which incorporates the 802.1p).

Table 97 IEEE 802.1p Priority Level and Traffic Type

PRIORITY LEVEL	TRAFFIC TYPE
Level 7	Typically used for network control traffic such as router configuration messages.
Level 6	Typically used for voice traffic that is especially sensitive to jitter (jitter is the variations in delay).
Level 5	Typically used for video that consumes high bandwidth and is sensitive to jitter.
Level 4	Typically used for controlled load, latency-sensitive traffic such as SNA (Systems Network Architecture) transactions.
Level 3	Typically used for "excellent effort" or better than best effort and would include important business traffic that can tolerate some delay.
Level 2	This is for "spare bandwidth".
Level 1	This is typically used for non-critical "background" traffic such as bulk transfers that are allowed but that should not affect other applications and users.
Level 0	Typically used for best-effort traffic.

## DiffServ

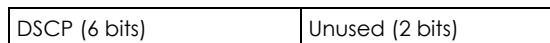
QoS is used to prioritize source-to-destination traffic flows. All packets in the flow are given the same priority. You can use CoS (class of service) to give different priorities to different packet types.

DiffServ (Differentiated Services) is a class of service (CoS) model that marks packets so that they receive specific per-hop treatment at DiffServ-compliant network devices along the route based on the application types and traffic flow. Packets are marked with DiffServ Code Points (DSCPs) indicating the level of service desired. This allows the intermediary DiffServ-compliant network devices to handle the packets differently depending on the code points without the need to negotiate paths or remember state information for every flow. In addition, applications do not have to request a particular service or give advanced notice of where the traffic is going.

## DSCP and Per-Hop Behavior

DiffServ defines a new Differentiated Services (DS) field to replace the Type of Service (ToS) field in the IP header. The DS field contains a 2-bit unused field and a 6-bit DSCP field which can define up to 64 service levels. The following figure illustrates the DS field.

DSCP is backward compatible with the three precedence bits in the ToS octet so that non-DiffServ compliant, ToS-enabled network device will not conflict with the DSCP mapping.



The DSCP value determines the forwarding behavior, the PHB (Per-Hop Behavior), that each packet gets across the DiffServ network. Based on the marking rule, different kinds of traffic can be marked for different kinds of forwarding. Resources can then be allocated according to the DSCP values and the configured policies.

## IP Precedence

Similar to IEEE 802.1p prioritization at layer-2, you can use IP precedence to prioritize packets in a layer-3 network. IP precedence uses three bits of the eight-bit ToS (Type of Service) field in the IP header. There

are eight classes of services (ranging from zero to seven) in IP precedence. Zero is the lowest priority level and seven is the highest.

## Automatic Priority Queue Assignment

If you enable QoS on the Zyxel Device, the Zyxel Device can automatically base on the IEEE 802.1p priority level, IP precedence and/or packet length to assign priority to traffic which does not match a class.

The following table shows you the internal layer-2 and layer-3 QoS mapping on the Zyxel Device. On the Zyxel Device, traffic assigned to higher priority queues gets through faster while traffic in lower index queues is dropped if the network is congested.

Table 98 Internal Layer2 and Layer3 QoS Mapping

PRIORITY QUEUE	LAYER 2	LAYER 3		
	IEEE 802.1P USER PRIORITY (ETHERNET PRIORITY)	TOS (IP PRECEDENCE)	DSCP	IP PACKET LENGTH (BYTE)
0	1	0	000000	
1	2			
2	0	0	000000	>1100
3	3	1	001110 001100 001010 001000	250 – 1100
4	4	2	010110 010100 010010 010000	
5	5	3	011110 011100 011010 011000	<250
6	6	4	100110 100100 100010 100000	
		5	101110 101000	
7	7	6	110000	
		7	111000	



## Token Bucket

The token bucket algorithm uses tokens in a bucket to control when traffic can be transmitted. The bucket stores tokens, each of which represents one byte. The algorithm allows bursts of up to  $b$  bytes which is also the bucket size, so the bucket can hold up to  $b$  tokens. Tokens are generated and added into the bucket at a constant rate. The following shows how tokens work with packets:

- A packet can be transmitted if the number of tokens in the bucket is equal to or greater than the size of the packet (in bytes).
- After a packet is transmitted, a number of tokens corresponding to the packet size is removed from the bucket.
- If there are no tokens in the bucket, the Zyxel Device stops transmitting until enough tokens are generated.
- If not enough tokens are available, the Zyxel Device treats the packet in either one of the following ways:

In traffic shaping:

- Holds it in the queue until enough tokens are available in the bucket.

In traffic policing:

- Drops it.
- Transmits it but adds a DSCP mark. The Zyxel Device may drop these marked packets if the network is overloaded.

Configure the bucket size to be equal to or less than the amount of the bandwidth that the interface can support. It does not help if you set it to a bucket size over the interface's capability. The smaller the bucket size, the lower the data transmission rate and that may cause outgoing packets to be dropped. A larger transmission rate requires a big bucket size. For example, use a bucket size of 10 kbytes to get the transmission rate up to 10 Mbps.

## Single Rate Three Color Marker

The Single Rate Three Color Marker (srTCM, defined in RFC 2697) is a type of traffic policing that identifies packets by comparing them to one user-defined rate, the Committed Information Rate (CIR), and two burst sizes: the Committed Burst Size (CBS) and Excess Burst Size (EBS).

The srTCM evaluates incoming packets and marks them with one of three colors which refer to packet loss priority levels. High packet loss priority level is referred to as red, medium is referred to as yellow and low is referred to as green.

The srTCM is based on the token bucket filter and has two token buckets (CBS and EBS). Tokens are generated and added into the bucket at a constant rate, called Committed Information Rate (CIR). When the first bucket (CBS) is full, new tokens overflow into the second bucket (EBS).

All packets are evaluated against the CBS. If a packet does not exceed the CBS it is marked green. Otherwise it is evaluated against the EBS. If it is below the EBS then it is marked yellow. If it exceeds the EBS then it is marked red.

The following shows how tokens work with incoming packets in srTCM:

- A packet arrives. The packet is marked green and can be transmitted if the number of tokens in the CBS bucket is equal to or greater than the size of the packet (in bytes).
- After a packet is transmitted, a number of tokens corresponding to the packet size is removed from the CBS bucket.

- If there are not enough tokens in the CBS bucket, the Zyxel Device checks the EBS bucket. The packet is marked yellow if there are sufficient tokens in the EBS bucket. Otherwise, the packet is marked red. No tokens are removed if the packet is dropped.

## Two Rate Three Color Marker

The Two Rate Three Color Marker (trTCM, defined in RFC 2698) is a type of traffic policing that identifies packets by comparing them to two user-defined rates: the Committed Information Rate (CIR) and the Peak Information Rate (PIR). The CIR specifies the average rate at which packets are admitted to the network. The PIR is greater than or equal to the CIR. CIR and PIR values are based on the guaranteed and maximum bandwidth respectively as negotiated between a service provider and client.

The trTCM evaluates incoming packets and marks them with one of three colors which refer to packet loss priority levels. High packet loss priority level is referred to as red, medium is referred to as yellow and low is referred to as green.

The trTCM is based on the token bucket filter and has two token buckets (Committed Burst Size (CBS) and Peak Burst Size (PBS)). Tokens are generated and added into the two buckets at the CIR and PIR respectively.

All packets are evaluated against the PIR. If a packet exceeds the PIR it is marked red. Otherwise it is evaluated against the CIR. If it exceeds the CIR then it is marked yellow. Finally, if it is below the CIR then it is marked green.

The following shows how tokens work with incoming packets in trTCM:

- A packet arrives. If the number of tokens in the PBS bucket is less than the size of the packet (in bytes), the packet is marked red and may be dropped regardless of the CBS bucket. No tokens are removed if the packet is dropped.
- If the PBS bucket has enough tokens, the Zyxel Device checks the CBS bucket. The packet is marked green and can be transmitted if the number of tokens in the CBS bucket is equal to or greater than the size of the packet (in bytes). Otherwise, the packet is marked yellow.

# CHAPTER 13

# Network Address Translation (NAT)

## 13.1 NAT Overview

NAT (Network Address Translation – NAT, RFC 1631) is the translation of the IP address of a host in a packet, for example, the source address of an outgoing packet, used within one network to a different IP address known within another network.

### 13.1.1 What You Can Do in this Chapter

- Use the **Port Forwarding** screen to configure forward incoming service requests to the servers on your local network ([Section 13.2 on page 332](#)).
- Use the **Port Triggering** screen to add and configure the Zyxel Device's trigger port settings ([Section 13.3 on page 335](#)).
- Use the **DMZ** screen to configure a default server ([Section 13.4 on page 338](#)).
- Use the **ALG** screen to enable or disable the SIP ALG ([Section 13.5 on page 339](#)).
- Use the **Address Mapping** screen to enable and disable the NAT Address Mapping in the Zyxel Device ([Section 13.6 on page 340](#)).
- Use the **Sessions** screen to limit the number of concurrent NAT sessions each client can use ([Section 13.7 on page 343](#)).
- Use the **Port Control Protocol** screen to configure incoming traffic for devices behind the Zyxel Device ([Section 13.8 on page 343](#)).

### 13.1.2 What You Need To Know

The following terms and concepts may help as you read this chapter.

#### Inside/Outside and Global/Local

Inside/outside denotes where a host is located relative to the Zyxel Device, for example, the computers of your subscribers are the inside hosts, while the web servers on the Internet are the outside hosts.

Global/local denotes the IP address of a host in a packet as the packet traverses a router, for example, the local address refers to the IP address of a host when the packet is in the local network, while the global address refers to the IP address of the host when the same packet is traveling in the WAN side.

#### NAT

In the simplest form, NAT changes the source IP address in a packet received from a subscriber (the inside local address) to another (the inside global address) before forwarding the packet to the WAN

side. When the response comes back, NAT translates the destination address (the inside global address) back to the inside local address before forwarding it to the original inside host.

## Port Forwarding

A port forwarding set is a list of inside (behind NAT on the LAN) servers, for example, web or FTP, that you can make visible to the outside world even though NAT makes your whole inside network appear as a single computer to the outside world.

## 13.2 Port Forwarding

Use **Port Forwarding** to forward incoming service requests from the Internet to the servers on your local network. Port forwarding is commonly used when you want to host online gaming, P2P file sharing, or other servers on your network.

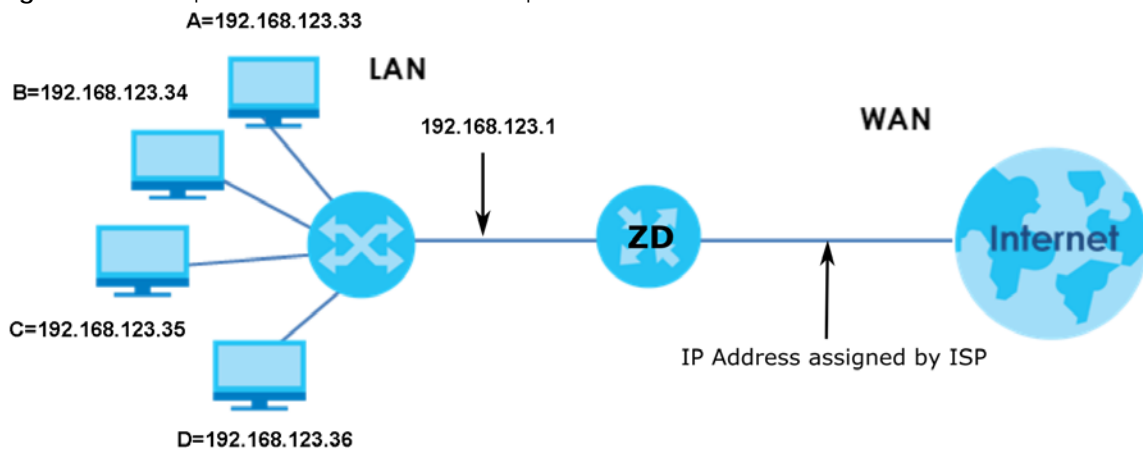
You may enter a single port number or a range of port numbers to be forwarded, and the local IP address of the desired server. The port number identifies a service; for example, web service is on port 80 and FTP on port 21. In some cases, such as for unknown services or where one server can support more than one service (for example both FTP and web service), it might be better to specify a range of port numbers. You can allocate a server IP address that corresponds to a port or a range of ports. Please refer to RFC 1700 for further information about port numbers.

Note: Many residential broadband ISP accounts do not allow you to run any server processes (such as a Web or FTP server) from your location. Your ISP may periodically check for servers and may suspend your account if it discovers any active services at your location. If you are unsure, refer to your ISP.

### Configure Servers Behind Port Forwarding (Example)

Let's say you want to assign ports 21-25 to one FTP, Telnet and SMTP server (**A** in the example), port 80 to another (**B** in the example), a default server IP address of 192.168.1.35 to a third (**C** in the example), and a default server IP address of 192.168.1.36 to a fourth (**D** in the example). You assign the LAN IP addresses and the ISP assigns the WAN IP address. The NAT network appears as a single host on the Internet.

**Figure 168** Multiple Servers Behind NAT Example

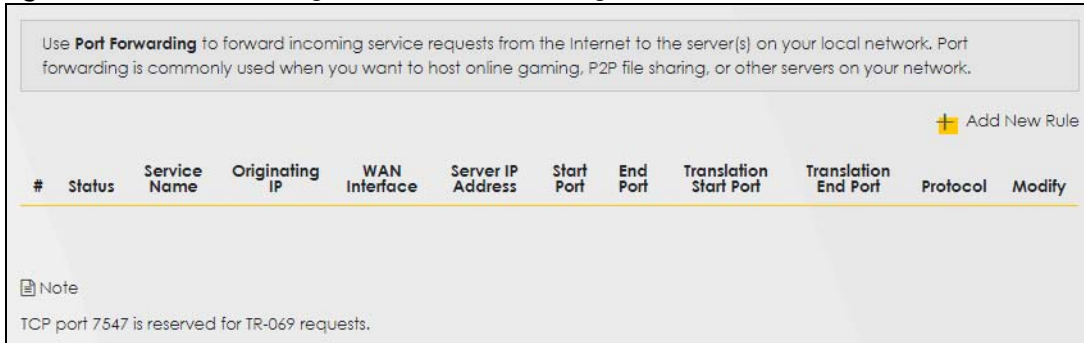


## 13.2.1 Port Forwarding

Click **Network Setting** > **NAT** to open the **Port Forwarding** screen.

Note: TCP port 7547 is reserved for system use.

**Figure 169** Network Setting > NAT > Port Forwarding



The following table describes the fields in this screen.

Table 99 Network Setting > NAT > Port Forwarding

LABEL	DESCRIPTION
Add New Rule	Click this to add a new port forwarding rule.
#	This is the index number of the entry.
Status	This field indicates whether the rule is active or not. A yellow bulb signifies that this rule is active. A gray bulb signifies that this rule is not active.
Service Name	This is the service's name. This shows <b>User Defined</b> if you manually added a service. You can change this by clicking the edit icon.
Originating IP	This is the source's IP address.
WAN Interface	Select the WAN interface for which to configure NAT port forwarding rules.
Server IP Address	This is the server's IP address.
Start Port	This is the first external port number that identifies a service.
End Port	This is the last external port number that identifies a service.
Translation Start Port	This is the first internal port number that identifies a service.
Translation End Port	This is the last internal port number that identifies a service.
Protocol	This field displays the protocol (TCP, UDP, TCP+UDP) used to transport the packets for which you want to apply the rule.
Modify	Click the <b>Edit</b> icon to edit the port forwarding rule.  Click the <b>Delete</b> icon to delete an existing port forwarding rule. Note that subsequent address mapping rules move up by one when you take this action.

## 13.2.2 Add or Edit Port Forwarding

Create or edit a port forwarding rule. Specify either a port or a range of ports, a server IP address, and a protocol to configure a port forwarding rule. Click **Add New Rule** in the **Port Forwarding** screen or the **Edit** icon next to an existing rule to open the following screen.

**Figure 170** Network Setting > NAT > Port Forwarding: Add or Edit

**Add New Rule**

Active

Service Name

WAN Interface

Start Port

End Port

Translation Start Port

Translation End Port

Server IP Address

Configure Originating IP  Enable

Originating IP

Protocol

**Note**

(1) Create or edit a port forwarding rule. Specify either a port or a range of ports, a server IP address, and a protocol to configure a port forwarding rule.

(2) To configure port forwarding, you need to have the same configurations in the **Start Port**, **End Port**, **Translation Start Port**, and **Translation End Port** fields.  
To configure port translation, you need to have different configurations in the **Start Port**, **End Port**, **Translation Start Port**, and **Translation End Port** fields.

(3) TCP port 7547 is reserved for system use.

Cancel OK

Note: To configure port forwarding, you need to have the same configurations in the **Start Port**, **End Port**, **Translation Start Port**, and **Translation End Port** fields.  
To configure port translation, you need to have different configurations in the **Start Port**, **End Port**, **Translation Start Port**, and **Translation End Port** fields.  
Here is an example to configure port translation. Configure **Start Port** to 100, **End Port** to 120, **Translation Start Port** to 200, and **Translation End Port** to 220.

Note: TCP port 7547 is reserved for system use.

The following table describes the labels in this screen.

Table 100 Network Setting &gt; NAT &gt; Port Forwarding: Add or Edit

LABEL	DESCRIPTION
Active	Click to turn the port forwarding rule on or off.
Service Name	Enter a name for the service to forward. You can use up to 256 printable characters except [ " ], [ ` ], [ ' ], [ < ], [ > ], [ ^ ], [ \$ ], [   ], [ & ], or [ ; ]. Spaces are allowed.
WAN Interface	Select the WAN interface for which to configure NAT port forwarding rules.

Table 100 Network Setting &gt; NAT &gt; Port Forwarding: Add or Edit (continued)

LABEL	DESCRIPTION
Start Port	Configure this for a user-defined entry. Enter the original destination port for the packets. To forward only one port, enter the port number again in the <b>End Port</b> field. To forward a series of ports, enter the start port number here and the end port number in the <b>End Port</b> field.
End Port	Configure this for a user-defined entry. Enter the last port of the original destination port range. To forward only one port, enter the port number in the <b>Start Port</b> field above and then enter it again in this field. To forward a series of ports, enter the last port number in a series that begins with the port number in the <b>Start Port</b> field above.
Translation Start Port	Configure this for a user-defined entry. This shows the port number to which you want the Zyxel Device to translate the incoming port. For a range of ports, enter the first number of the range to which you want the incoming ports translated.
Translation End Port	Configure this for a user-defined entry. This shows the last port of the translated port range.
Server IP Address	Enter the inside IP address of the virtual server here.
Configure Originating IP	Click the <b>Enable</b> check box to enter the source IP in the next field.
Originating IP	Enter the source IP address here.
Protocol	Select the protocol supported by this virtual server. Choices are <b>TCP</b> , <b>UDP</b> , or <b>TCP/UDP</b> .
OK	Click this to save your changes.
Cancel	Click this to exit this screen without saving.

## 13.3 Port Triggering

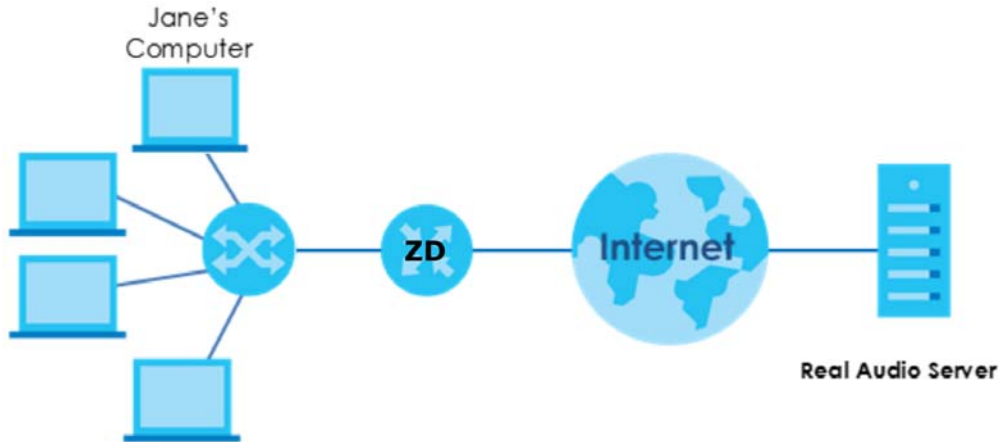
Some services use a dedicated range of ports on the client side and a dedicated range of ports on the server side. With regular port forwarding, you set a forwarding port in NAT to forward a service (coming in from the server on the WAN) to the IP address of a computer on the client side (LAN). The problem is that port forwarding only forwards a service to a single LAN IP address. In order to use the same service on a different LAN computer, you have to manually replace the LAN computer's IP address in the forwarding port with another LAN computer's IP address.

Trigger port forwarding allows computers on the LAN to dynamically take turns using the service.

The Zyxel Device records the IP address of a LAN computer that sends traffic to the WAN to request a service with a specific port number and protocol (a `"trigger"` port). When the Zyxel Device's WAN port receives a response with a specific port number and protocol (`"open"` port), the Zyxel Device forwards the traffic to the LAN IP address of the computer that sent the request. After that computer's connection for that service closes, another computer on the LAN can use the service in the same manner. This way you do not need to configure a new IP address each time you want a different LAN computer to use the application.

For example:

**Figure 171** Trigger Port Forwarding Process: Example



- 1 Jane requests a file from the Real Audio server (port 7070).
- 2 Port 7070 is a "trigger" port and causes the Zyxel Device to record Jane's computer IP address. The Zyxel Device associates Jane's computer IP address with the "open" port range of 6970 – 7170.
- 3 The Real Audio server responds using a port number ranging between 6970 – 7170.
- 4 The Zyxel Device forwards the traffic to Jane's computer IP address.
- 5 Only Jane can connect to the Real Audio server until the connection is closed or times out. The Zyxel Device times out in 3 minutes with UDP (User Datagram Protocol) or 2 hours with TCP/IP (Transfer Control Protocol/Internet Protocol).

Click **Network Setting > NAT > Port Triggering** to open the following screen. Use this screen to view your Zyxel Device's trigger port settings.

Note: TCP port 7547 is reserved for system use.

Note: The sum of trigger ports in all rules must be less than 1000 and every open port range must be less than 1000. When the protocol is TCP/UDP, the ports are counted twice.

**Figure 172** Network Setting > NAT > Port Triggering

#	Status	Service Name	WAN Interface	Trigger Start Port	Trigger End Port	Trigger Proto.	Open Start Port	Open End Port	Open Protocol	Modify
+ Add New Rule										

The following table describes the labels in this screen.

Table 101 Network Setting > NAT > Port Triggering

LABEL	DESCRIPTION
Add New Rule	Click this to create a new rule.
#	This is the index number of the entry.
Status	This field displays whether the port triggering rule is active or not. A yellow bulb signifies that this rule is active. A gray bulb signifies that this rule is not active.



Table 101 Network Setting &gt; NAT &gt; Port Triggering (continued)

LABEL	DESCRIPTION
Service Name	This field displays the name of the service used by this rule.
WAN Interface	This field shows the WAN interface through which the service is forwarded.
Trigger Start Port	The trigger port is a port (or a range of ports) that causes (or triggers) the Zyxel Device to record the IP address of the LAN computer that sent the traffic to a server on the WAN.  This is the first port number that identifies a service.
Trigger End Port	This is the last port number that identifies a service.
Trigger Proto.	This is the trigger transport layer protocol.
Open Start Port	The open port is a port (or a range of ports) that a server on the WAN uses when it sends out a particular service. The Zyxel Device forwards the traffic with this port (or range of ports) to the client computer on the LAN that requested the service.  This is the first port number that identifies a service.
Open End Port	This is the last port number that identifies a service.
Open Protocol	This is the open transport layer protocol.
Modify	Click the <b>Edit</b> icon to edit this rule.  Click the <b>Delete</b> icon to delete an existing rule.

### 13.3.1 Add or Edit Port Triggering Rule

This screen lets you create new port triggering rules. Click **Add New Rule** in the **Port Triggering** screen or click a rule's **Edit** icon to open the following screen. Use this screen to configure a port or range of ports and protocols for sending out requests and for receiving responses.

Figure 173 Network Setting &gt; NAT &gt; Port Triggering: Add or Edit

The screenshot shows the 'Add New Rule' configuration screen. It features a back arrow in the top left corner. The title 'Add New Rule' is centered at the top. Below the title, there is a list of configuration options:

- Active:** A toggle switch that is currently turned on (blue).
- Service Name:** A text input field.
- WAN Interface:** A dropdown menu with 'Default' selected.
- Trigger Start Port:** A text input field.
- Trigger End Port:** A text input field.
- Trigger Protocol:** A dropdown menu with 'TCP' selected.
- Open Start Port:** A text input field.
- Open End Port:** A text input field.
- Open Protocol:** A dropdown menu with 'TCP' selected.

At the bottom of the screen, there are two buttons: 'Cancel' and 'OK'.

The following table describes the labels in this screen.

Table 102 Network Setting > NAT > Port Triggering: Add or Edit

LABEL	DESCRIPTION
Active	Click this switch to activate this rule.
Service Name	Enter a name to identify this rule. You can use up to 256 printable characters except [ " ], [ ` ], [ ' ], [ < ], [ > ], [ ^ ], [ \$ ], [   ], [ & ], or [ ; ]. Spaces are allowed.
WAN Interface	Select a WAN interface for which you want to configure port triggering rules.
Trigger Start Port	The trigger port is a port (or a range of ports) that causes (or triggers) the Zyxel Device to record the IP address of the LAN computer that sent the traffic to a server on the WAN. Enter a port number or the starting port number in a range of port numbers.
Trigger End Port	Enter a port number or the ending port number in a range of port numbers.
Trigger Protocol	Select the transport layer protocol from <b>TCP</b> , <b>UDP</b> , or <b>TCP/UDP</b> .
Open Start Port	The open port is a port (or a range of ports) that a server on the WAN uses when it sends out a particular service. The Zyxel Device forwards the traffic with this port (or range of ports) to the client computer on the LAN that requested the service. Enter a port number or the starting port number in a range of port numbers.
Open End Port	Enter a port number or the ending port number in a range of port numbers.
Open Protocol	Select the transport layer protocol from <b>TCP</b> , <b>UDP</b> , or <b>TCP/UDP</b> .
Cancel	Click <b>Cancel</b> to exit this screen without saving.
OK	Click <b>OK</b> to save your changes.

## 13.4 DMZ

Use this screen to specify the IP address of a default server to receive packets from ports not specified in the **Port Triggering** screen. The DMZ (DeMilitarized Zone) is a network between the WAN and the LAN that is accessible to devices on both the WAN and LAN with firewall protection. Devices on the WAN can initiate connections to devices on the DMZ but not to those on the LAN.

You can put public servers, such as email, web, and FTP servers, on the DMZ to provide services on both the WAN and LAN. To use this feature, you first need to assign a DMZ host. Click **Network Setting > NAT > DMZ** to open the **DMZ** screen.

Note: Use an IPv4 address for the DMZ server.

Note: Enter the IP address of the default server in the **Default Server Address** field, and click **Apply** to activate the DMZ host. Otherwise, clear the IP address in the **Default Server Address** field, and click **Apply** to deactivate the DMZ host.

**Figure 174** Network Setting > NAT > DMZ

Use this screen to specify the IP address of a default server to receive packets from ports not specified in the **Port Triggering** screen. The DMZ (DeMilitarized Zone) is a network between the WAN and the LAN that is accessible to devices on both the WAN and LAN with firewall protection. Devices on the WAN can initiate connections to devices on the DMZ but not to those on the LAN.

You can put public servers, such as email, web, and FTP servers, on the DMZ to provide services on both the WAN and LAN. To use this feature, you first need to assign a DMZ host.

Default Server Address

Note

Enter the IP address of the default server in the **Default Server Address** field, and click **Apply** to activate the DMZ host. Otherwise, clear the IP address in the **Default Server Address** field, and click **Apply** to deactivate the DMZ host.

The following table describes the fields in this screen.

Table 103 Network Setting &gt; NAT &gt; DMZ

LABEL	DESCRIPTION
Default Server Address	Enter the IP address of the default server which receives packets from ports that are not specified in the <b>Port Forwarding</b> screen.  Note: If you do not assign a default server, the Zyxel Device discards all packets received for ports not specified in the virtual server configuration.
Apply	Click this to save your changes back to the Zyxel Device.
Cancel	Click <b>Cancel</b> to restore your previously saved settings.

## 13.5 ALG

Application Layer Gateway (ALG) allows customized NAT traversal filters to support address and port translation for certain applications such as File Transfer Protocol (FTP), Session Initiation Protocol (SIP), or file transfer in Instant Messaging (IM) applications. It allows SIP calls to pass through the Zyxel Device. When the Zyxel Device registers with the SIP register server, the SIP ALG translates the Zyxel Device's private IP address inside the SIP data stream to a public IP address. You do not need to use STUN or an outbound proxy if your Zyxel Device is behind a SIP ALG.

Click **Network Setting > NAT > ALG** to open the **ALG** screen. Use this screen to enable and disable the NAT Application Layer Gateway (ALG) in the Zyxel Device.

Application Layer Gateway (ALG) allows certain applications such as File Transfer Protocol (FTP), Session Initiation Protocol (SIP), or file transfer in Instant Messaging (IM) applications to pass through the Zyxel Device.

**Figure 175** Network Setting > NAT > ALG

**NAT**

Port Forwarding | Port Triggering | DMZ | **ALG** | Address Mapping | Sessions

Application Layer Gateway (ALG) allows customized NAT traversal filters to support address and port translation for certain applications such as File Transfer Protocol (FTP), Session Initiation Protocol (SIP), or file transfer in Instant Messaging (IM) applications. It allows SIP calls to pass through the Zyxel Device.

NAT ALG

SIP ALG

RTSP ALG

PPTP ALG

IPSEC ALG

Cancel **Apply**

The following table describes the fields in this screen.

Table 104 Network Setting &gt; NAT &gt; ALG

LABEL	DESCRIPTION
NAT ALG	Enable this to make sure applications such as FTP and file transfer in IM applications work correctly with port-forwarding and address-mapping rules.
SIP ALG	Click this switch to enable SIP ALG to make sure SIP (VoIP) works correctly with port-forwarding and address-mapping rules.
RTSP ALG	Click this switch to enable RTSP ALG to have the Zyxel Device detect RTSP traffic and help build RTSP sessions through its NAT. The Real Time Streaming (media control) Protocol (RTSP) is a remote control for multimedia on the Internet.
PPTP ALG	Click this switch to enable the PPTP ALG on the Zyxel Device to detect PPTP traffic and help build PPTP sessions through the Zyxel Device's NAT.
IPSEC ALG	Click this switch to enable IPsec ALG on the Zyxel Device to detect IPsec traffic and help build IPsec sessions through the Zyxel Device's NAT.
Apply	Click <b>Apply</b> to save your changes back to the Zyxel Device.
Cancel	Click <b>Cancel</b> to restore your previously saved settings.

## 13.6 Address Mapping

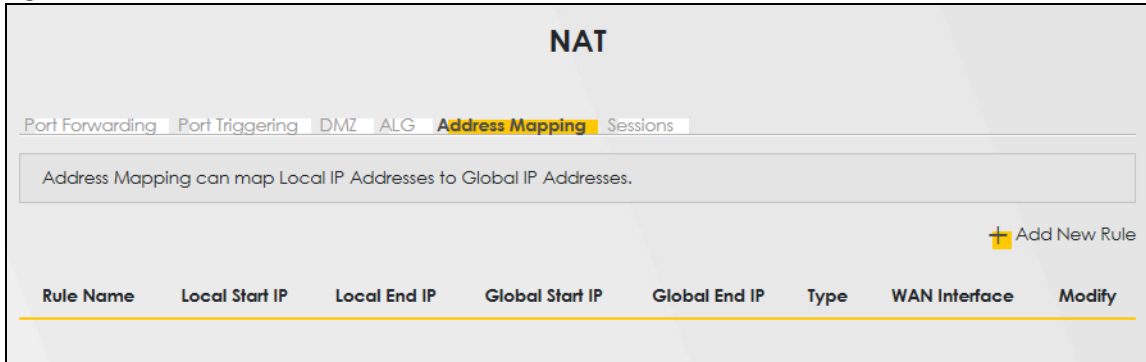
Address mapping can map local IP Addresses to global IP addresses. Ordering your rules is important because the Zyxel Device applies the rules in the order that you specify. When a rule matches the current packet, the Zyxel Device takes the corresponding action and the remaining rules are ignored.

Use this screen to enable or disable the NAT Address Mapping in the Zyxel Device.

### 13.6.1 Address Mapping Screen

Click **Network Setting > NAT > Address Mapping** to open the **Address Mapping** screen.

Figure 176 Network Setting &gt; NAT &gt; Address Mapping



The following table describes the fields in this screen.

Table 105 Network Setting &gt; NAT &gt; Address Mapping

LABEL	DESCRIPTION
Add New Rule	Click this to create a new rule.
Rule Name	This is the name of the rule.
Local Start IP	This is the starting Inside Local IP Address (ILA).
Local End IP	This is the ending Inside Local IP Address (ILA). If the rule is for all local IP addresses, then this field displays 0.0.0.0 as the Local Start IP address and 255.255.255.255 as the Local End IP address. This field is blank for <b>One-to-One</b> mapping types.
Global Start IP	This is the starting Inside Global IP Address (IGA). Enter 0.0.0.0 here if you have a dynamic IP address from your ISP. You can only do this for the <b>Many-to-One</b> mapping type.
Global End IP	This is the ending Inside Global IP Address (IGA). This field is blank for <b>One-to-One</b> and <b>Many-to-One</b> mapping types.
Type	This is the address mapping type.  <b>One-to-One:</b> This mode maps one local IP address to one global IP address. Note that port numbers do not change for the One-to-One NAT mapping type.  <b>Many-to-One:</b> This mode maps multiple local IP addresses to one global IP address. This is equivalent to SUA (i.e., PAT, port address translation), the Device's Single User Account feature that previous routers supported only.  <b>Many-to-Many:</b> This mode maps multiple local IP addresses to shared global IP addresses.
WAN Interface	This is the WAN interface to which the address mapping rule applies.
Modify	Click the <b>Edit</b> icon to go to the screen where you can edit the address mapping rule.  Click the <b>Delete</b> icon to delete an existing address mapping rule. Note that subsequent address mapping rules move up by one when you take this action.

## 13.6.2 Add New Rule Screen

To add or edit an address mapping rule, click **Add New Rule** or the **Modify** icon in the **Address Mapping** screen to display the screen shown next.

**Figure 177** Network Setting > NAT > Address Mapping > Add New Rule

The following table describes the fields in this screen.

**Table 106** Network Setting > NAT > Address Mapping > Add New Rule

LABEL	DESCRIPTION
Rule Name	Enter a descriptive name for this rule. You can use up to 20 printable characters except [ " ], [ ` ], [ ' ], [ < ], [ > ], [ ^ ], [ \$ ], [   ], [ & ], or [ ; ]. Spaces are allowed.
Type	Choose the IP or port mapping type from one of the following.  <b>One-to-One:</b> This mode maps one local IP address to one global IP address. Note that port numbers do not change for the One-to-One NAT mapping type.  <b>Many-to-One:</b> This mode maps multiple local IP addresses to one global IP address. This is equivalent to SUA (for example, PAT, port address translation), the device's Single User Account feature that previous routers supported only.  <b>Many-to-Many:</b> This mode maps multiple local IP addresses to shared global IP addresses.
Local Start IP	Enter the starting Inside Local IP Address (ILA).
Local End IP	Enter the ending Inside Local IP Address (ILA). If the rule is for all local IP addresses, then this field displays 0.0.0.0 as the Local Start IP address and 255.255.255.255 as the Local End IP address. This field is blank for <b>One-to-One</b> mapping types.
Global Start IP	Enter the starting Inside Global IP Address (IGA). Enter 0.0.0.0 here if you have a dynamic IP address from your ISP. You can only do this for the Many-to-One mapping type.
Global End IP	Enter the ending Inside Global IP Address (IGA). This field is blank for <b>One-to-One</b> and <b>Many-to-One</b> mapping types.
WAN Interface	Select a WAN interface to which the address mapping rule applies.
Cancel	Click <b>Cancel</b> to exit this screen without saving.
OK	Click <b>OK</b> to save your changes.

## 13.7 Sessions

Use this screen to limit the number of concurrent NAT sessions a client can use, to ensure that no single client uses up too many available NAT sessions. Some applications, such as P2P file sharing, demand a greater number of NAT sessions in order to get a better uploading and downloading rate. Click **Network Setting > NAT > Sessions** to display the following screen.

Use the **Sessions** screen to limit the number of concurrent NAT sessions each client can use. Click **Network Setting > NAT > Sessions** to open the **Sessions** screen.

Note: Enter a number of concurrent NAT sessions in the **MAX NAT Session Per Host** field, and click **Apply** to limit the number of concurrent NAT sessions a client can use. Otherwise, clear the number in the **MAX NAT Session Per Host** field. Click **Apply** and there is no limit for concurrent NAT sessions a client can use.

**Figure 178** Network Setting > NAT > Sessions

The following table describes the fields in this screen.

Table 107 Network Setting > NAT > Sessions

LABEL	DESCRIPTION
MAX NAT Session Per Host	Use this field to set a common limit to the number of concurrent NAT sessions each client computer can have.  If only a few clients use peer to peer applications, you can raise this number to improve their performance. With heavy peer to peer application use, lower this number to ensure no single client uses too many of the available NAT sessions.
Cancel	Click <b>Cancel</b> to restore your previously saved settings.
Apply	Click <b>Apply</b> to save your changes.

## 13.8 Port Control Protocol (PCP)

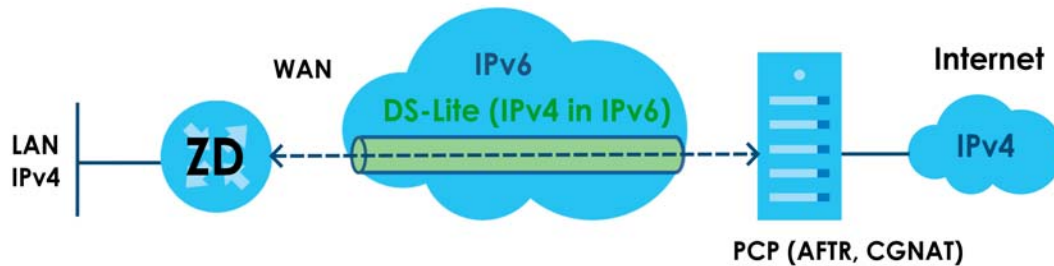
Use this screen to view, add, or delete PCP rules. Port Control Protocol (PCP) allows devices such as web or file sharing servers behind the Zyxel Device to receive incoming traffic.

## Example Applications

- Some remote access applications, such as remote desktop or SSH, require incoming traffic to be routed to the user's device in order to establish a remote connection. Use PCP to dynamically map incoming traffic to the user's device, allowing them to establish remote connections.

The PCP server allows dynamic mapping of external ports to internal IP addresses and ports. PCP allows devices to request and release mappings for specific ports, and to specify the lifetime of those mappings. This allows devices to dynamically open and close ports just as needed, and does not need keepalive packets that can drain battery life of home devices such as smartphones.

In the following figure, the Zyxel Device is the PCP client. DS-Lite tunnels IPv4 packets over an IPv6 network to an AFTR (Address Family Transition Router) and Carrier-Grade NAT (CGNAT) which includes the PCP server, then sends traffic to its external IPv4 network. The Port Control Protocol with DS Lite allows you to create PCP mapping rules with the PCP server.



## Requirement

You must enable DS Lite (Dual-Stack Lite) in **Network Setting > Broadband > Edit WAN Interface** to use PCP.

- If you select **Automatically configured by DHCP**, then the IP address of the PCP server is assigned to the Zyxel Device using DHCP Option 64.

DS-Lite

Automatically configured by DHCP

Manually Configured

- If you select **Manually Configured**, then you must enter the IPv6 address of the PCP server in the **DS-Lite Relay server IP** field.

DS-Lite

Automatically configured by DHCP

Manually Configured

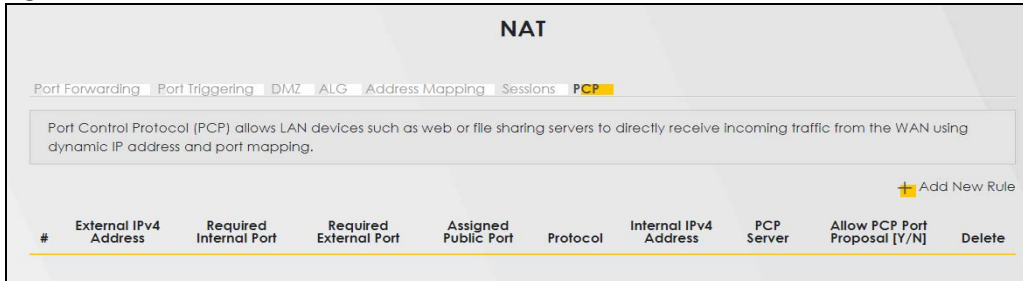
DS-Lite  
Relay Server  
IP

## Configuring PCP

Click **Network Setting > NAT > PCP** to display the following screen.



Figure 179 Network Setting &gt; NAT &gt; PCP



The following table describes the fields in this screen.

Table 108 Network Setting &gt; NAT &gt; PCP

LABEL	DESCRIPTION
Add New Rule	Click this to add a new PCP rule.
#	This is the index number of the rule.
External IPv4 Address	This displays the external IP address assigned by the PCP server. PCP maps from this IP address to the LAN device IP address.
Required Internal Port	This displays the internal port number that the PCP server maps to, from the external port.
Required External Port	This displays the proposed external port number that the PCP server maps from, to the internal port.
Assigned Public Port	This displays the allocated external port number assigned by the PCP server for the service on the WAN if Allow PCP Port Proposal is enabled. PCP maps from this port number to the internal port number.
Protocol	This is the protocol ( <b>TCP</b> or <b>UDP</b> ) for port number that identifies a service.
Internal IPv4 Address	This is the LAN device IP address. PCP maps the external IP address to this IP address.
PCP Server	This field displays the status of the PCP mapping request to the PCP server. <ul style="list-style-type: none"> <li>• <b>Succeeded</b> - The PCP server successfully mapped the external IP address and port to the internal IP address and port.</li> <li>• <b>Failed</b> - The PCP server failed to map the external IP address and port to the internal IP address and port. Make sure to select Allow PCP Port Proposal to allow the PCP server to assign an external IP address and port if the configured ones are not available.</li> </ul>
Allow PCP Port Proposal (Y/N)	This displays <b>Y</b> if the PCP server can assign a different external IP address and port to the required ones you configured.
Delete	Select a rule, then click this icon to remove the rule from the Zyxel Device.

### 13.8.1 Add New Rule Screen

To add a new PCP rule, click **Add New Rule**. To edit an existing rule, select the rule, then click the **Modify** icon. The following screen displays.

**Note:** Be careful not to configure conflicting mapping between PCP and NAT port forwarding for incoming traffic.

**Figure 180** Network Setting > NAT > PCP > Add New Rule

The following table describes the fields in this screen.

**Table 109** Network Setting > NAT > PCP > Add New Rule

LABEL	DESCRIPTION
Required Internal Port	Enter an internal port number that the PCP server maps to, from the external port.
Required External Port	Enter a proposed external port number that the PCP server maps from, to the internal port.
Protocol	Select the transport layer protocol. Choices are <b>TCP</b> and <b>UDP</b> . See the Service Appendix to see what services require what protocol and port number.
Internal IPv4 Address	Enter the IP address of the LAN device. PCP maps the external IP address to this IP address.
Allow PCP Port Proposal	Select this to allow the PCP server to assign an external IP address and port. If you clear this, PCP mapping will fail if the required ones configured are not available on the PCP server.
Cancel	Click <b>Cancel</b> to exit this screen without saving.
OK	Click <b>OK</b> to save your changes.

## 13.9 Technical Reference

This part contains more information regarding NAT.

### 13.9.1 NAT Definitions

Inside or outside denotes where a host is located relative to the Zyxel Device, for example, the computers of your subscribers are the inside hosts, while the web servers on the Internet are the outside hosts.

Global or local denotes the IP address of a host in a packet as the packet traverses a router, for example, the local address refers to the IP address of a host when the packet is in the local network, while the global address refers to the IP address of the host when the same packet is traveling in the WAN side.

Note that inside or outside refers to the location of a host, while global/local refers to the IP address of a

host used in a packet. Thus, an inside local address (ILA) is the IP address of an inside host in a packet when the packet is still in the local network, while an inside global address (IGA) is the IP address of the same inside host when the packet is on the WAN side. The following table summarizes this information.

Table 110 NAT Definitions

ITEM	DESCRIPTION
Inside	This refers to the host on the LAN.
Outside	This refers to the host on the WAN.
Local	This refers to the packet address (source or destination) as the packet travels on the LAN.
Global	This refers to the packet address (source or destination) as the packet travels on the WAN.

NAT never changes the IP address (either local or global) of an outside host.

## 13.9.2 What NAT Does

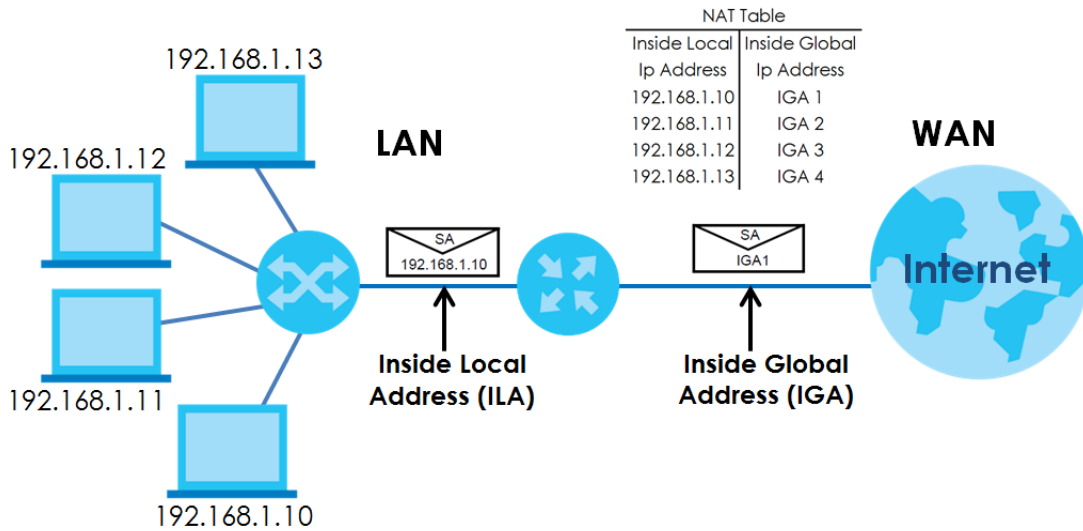
In the simplest form, NAT changes the source IP address in a packet received from a subscriber (the inside local address) to another (the inside global address) before forwarding the packet to the WAN side. When the response comes back, NAT translates the destination address (the inside global address) back to the inside local address before forwarding it to the original inside host. Note that the IP address (either local or global) of an outside host is never changed.

The global IP addresses for the inside hosts can be either static or dynamically assigned by the ISP. In addition, you can designate servers, for example, a web server and a telnet server, on your local network and make them accessible to the outside world. If you do not define any servers (for Many-to-One and Many-to-Many Overload mapping), NAT offers the additional benefit of firewall protection. With no servers defined, your Zyxel Device filters out all incoming inquiries, thus preventing intruders from probing your network. For more information on IP address translation, refer to *RFC 1631, The IP Network Address Translator (NAT)*.

## 13.9.3 How NAT Works

Each packet has two addresses – a source address and a destination address. For outgoing packets, the ILA (Inside Local Address) is the source address on the LAN, and the IGA (Inside Global Address) is the source address on the WAN. For incoming packets, the ILA is the destination address on the LAN, and the IGA is the destination address on the WAN. NAT maps private (local) IP addresses to globally unique ones required for communication with hosts on other networks. It replaces the original IP source address (and TCP or UDP source port numbers for Many-to-One and Many-to-Many Overload NAT mapping) in each packet and then forwards it to the Internet. The Zyxel Device keeps track of the original addresses and port numbers so incoming reply packets can have their original values restored. The following figure illustrates this.

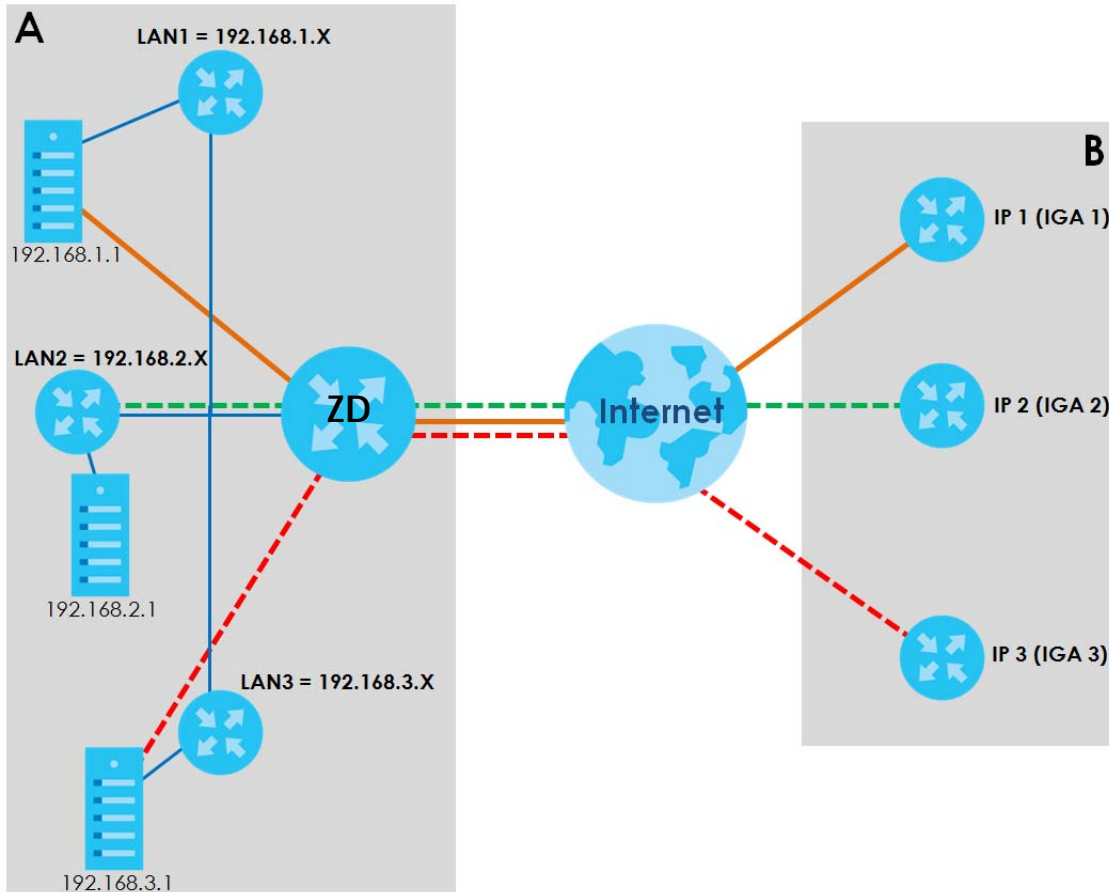
Figure 181 How NAT Works



### 13.9.4 NAT Application

The following figure illustrates a possible NAT application, where three inside LANs (logical LANs using IP alias) behind the Zyxel Device can communicate with three distinct WAN networks.

Figure 182 NAT Application With IP Alias



## Port Forwarding: Services and Port Numbers

The most often used port numbers are shown in the following table. Please refer to RFC 1700 for further information about port numbers. Please also refer to the Supporting CD for more examples and details on port forwarding and NAT.

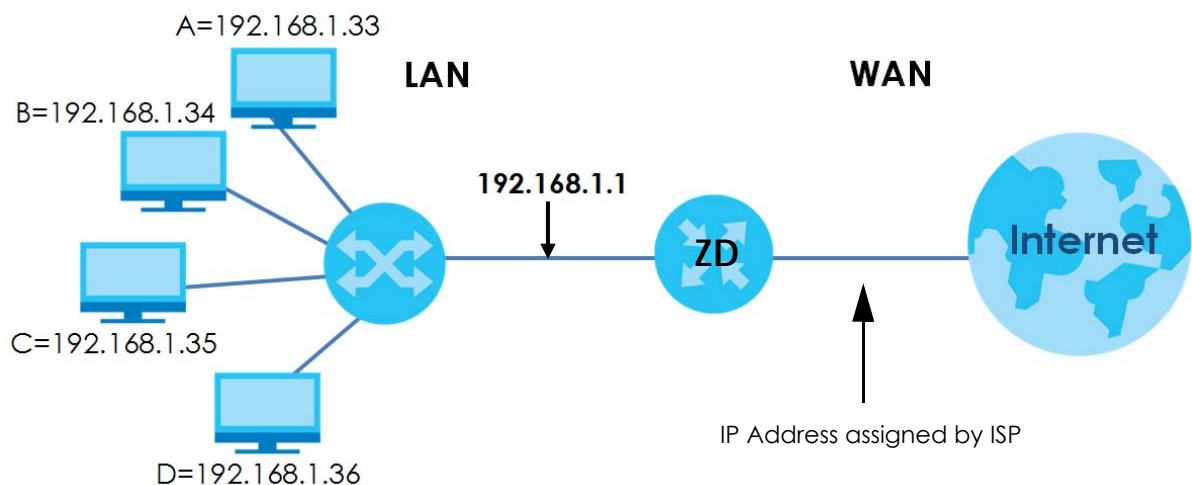
Table 111 Services and Port Numbers

SERVICES	PORT NUMBER
ECHO	7
FTP (File Transfer Protocol)	21
SMTP (Simple Mail Transfer Protocol)	25
DNS (Domain Name System)	53
Finger	79
HTTP (Hyper Text Transfer protocol or WWW, Web)	80
POP3 (Post Office Protocol)	110
NNTP (Network News Transport Protocol)	119
SNMP (Simple Network Management Protocol)	161
SNMP trap	162
PPTP (Point-to-Point Tunneling Protocol)	1723

## Port Forwarding Example

Let's say you want to assign ports 21 – 25 to one FTP, Telnet and SMTP server (**A** in the example), port 80 to another (**B** in the example) and assign a default server IP address of 192.168.1.35 to a third (**C** in the example). You assign the LAN IP addresses and the ISP assigns the WAN IP address. The NAT network appears as a single host on the Internet.

Figure 183 Multiple Servers Behind NAT Example



# CHAPTER 14

## DNS

### 14.1 DNS Overview

#### DNS

DNS (Domain Name System) is for mapping a domain name to its corresponding IP address and vice versa. The DNS server is extremely important because without it, you must know the IP address of a machine before you can access it.

In addition to the system DNS servers, each WAN interface (service) is set to have its own static or dynamic DNS server list. You can configure a DNS static route to forward DNS queries for certain domain names through a specific WAN interface to its DNS servers. The Zyxel Device uses a system DNS server (in the order you specify in the **Broadband** screen) to resolve domain names that do not match any DNS routing entry. After the Zyxel Device receives a DNS reply from a DNS server, it creates a new entry for the resolved IP address in the routing table.

Note: For information on configuring DNS route, see [Chapter 11 on page 299](#).

#### Dynamic DNS

Dynamic DNS allows you to use a dynamic IP address with one or many dynamic DNS services so that anyone can contact you (in NetMeeting, CU-SeeMe, etc.). You can also access your FTP server or Web site on your own computer using a domain name (for instance myhost.dhs.org, where myhost is a name of your choice) that will never change instead of using an IP address that changes each time you reconnect. Your friends or relatives will always be able to call you even if they do not know your IP address.

You first need to have registered a dynamic DNS account with [www.dyndns.org](http://www.dyndns.org). This is for people with a dynamic IP from their ISP or DHCP server that would still like to have a domain name. The Dynamic DNS service provider will give you a password or key.

#### 14.1.1 What You Can Do in this Chapter

- Use the **DNS Entry** screen to view, configure, or remove DNS routes ([Section 14.2 on page 351](#)).
- Use the **Dynamic DNS** screen to enable DDNS and configure the DDNS settings on the Zyxel Device ([Section 14.3 on page 352](#)).

## 14.1.2 What You Need To Know

### DYNDNS Wildcard

Enabling the wildcard feature for your host causes \*.yourhost.dyndns.org to be aliased to the same IP address as yourhost.dyndns.org. This feature is useful if you want to be able to use, for example, www.yourhost.dyndns.org and still reach your hostname.

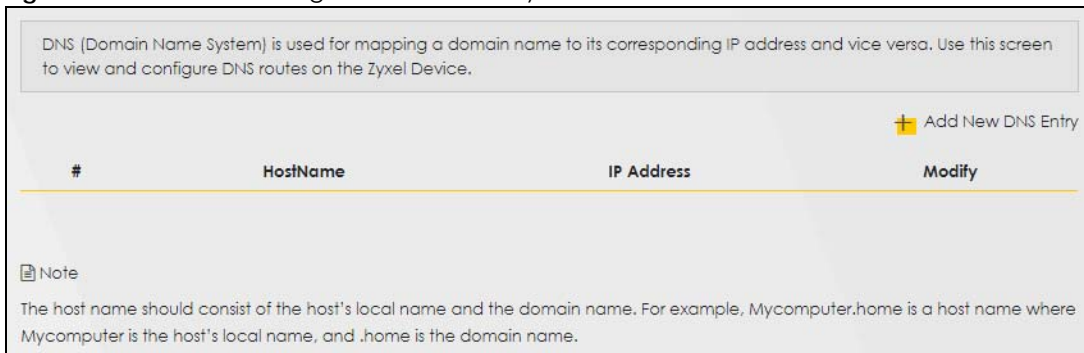
If you have a private WAN IP address, then you cannot use Dynamic DNS.

## 14.2 DNS Entry

DNS (Domain Name System) is used for mapping a domain name to its corresponding IP address and vice versa. Use this screen to view and configure manual DNS entries on the Zyxel Device. Click **Network Setting > DNS** to open the **DNS Entry** screen.

Note: The host name should consist of the host's local name and the domain name. For example, Mycomputer.home is a host name where Mycomputer is the host's local name, and .home is the domain name.

**Figure 184** Network Setting > DNS > DNS Entry



The following table describes the fields in this screen.

**Table 112** Network Setting > DNS > DNS Entry

LABEL	DESCRIPTION
Add New DNS Entry	Click this to create a new DNS entry.
#	This is the index number of the entry.
HostName	This indicates the host name or domain name.
IP Address	This indicates the IP address assigned to this computer.
Modify	Click the <b>Edit</b> icon to edit the rule. Click the <b>Delete</b> icon to delete an existing rule.

## 14.2.1 Add or Edit DNS Entry

You can manually add or edit the Zyxel Device's DNS name and IP address entry. Click **Add New DNS Entry** in the **DNS Entry** screen or the **Edit** icon next to the entry you want to edit. The screen shown next appears.

**Figure 185** Network Setting > DNS > DNS Entry: Add or Edit

The following table describes the labels in this screen.

Table 113 Network Setting > DNS > DNS Entry: Add or Edit

LABEL	DESCRIPTION
Host Name	Enter the host name of the DNS entry. You can use up to 256 alphanumeric (0-9, a-z, A-Z) characters with hyphens [ - ] and periods [ . ].  You can use the wildcard character, an "*" (asterisk) as the left most part of a domain name, such as *.example.com.
IPv4 Address	Enter the IPv4 address of the DNS entry.
Cancel	Click <b>Cancel</b> to exit this screen without saving.
OK	Click <b>OK</b> to save your changes.

## 14.3 Dynamic DNS

Dynamic DNS can update your current dynamic IP address mapping to a hostname. Configure a DDNS service provider on your Zyxel Device. Click **Network Setting > DNS > Dynamic DNS**. The screen appears as shown.



**Figure 186** Network Setting > DNS > Dynamic DNS

Dynamic DNS can update your current dynamic IP address mapping to a hostname. Configure a DDNS service provider on your Zyxel Device.

### Dynamic DNS Setup

Dynamic DNS  Enable  Disable (Settings are invalid when disable)

Service Provider

Host Name

Username

Password

Enable Wildcard Option

Enable Off Line Option (Only applies to custom DNS)

### Dynamic DNS Status

User Authentication Result

Last Updated Time

Current Dynamic IP

The following table describes the fields in this screen.

Table 114 Network Setting &gt; DNS &gt; Dynamic DNS

LABEL	DESCRIPTION
Dynamic DNS Setup	
Dynamic DNS	Select <b>Enable</b> to use dynamic DNS.
Service Provider	Select your Dynamic DNS service provider from the drop-down list box.
Host Name	Enter the domain name assigned to your Zyxel Device by your Dynamic DNS provider. You can use up to 256 alphanumeric (0-9, a-z, A-Z) characters with hyphens [ - ] and periods [ . ]. You can specify up to two host names in the field separated by a comma (",").
Username	Enter your user name.
Password	Enter the password assigned to you.
Enable Wildcard Option	Select the check box to enable DynDNS Wildcard.
Enable Off Line Option (Only applies to custom DNS)	Check with your Dynamic DNS service provider to have traffic redirected to a URL (that you can specify) while you are off line.
Dynamic DNS Status	
User Authentication Result	This shows <b>Success</b> if the account is correctly set up with the Dynamic DNS provider account.
Last Updated Time	This shows the last time the IP address the Dynamic DNS provider has associated with the hostname was updated.
Current Dynamic IP	This shows the IP address your Dynamic DNS provider has currently associated with the hostname.

Table 114 Network Setting &gt; DNS &gt; Dynamic DNS (continued)

LABEL	DESCRIPTION
Cancel	Click <b>Cancel</b> to exit this screen without saving.
Apply	Click <b>Apply</b> to save your changes.

# CHAPTER 15

## IGMP/MLD

### 15.1 IGMP/MLD Overview

Multicast delivers IP packets to a group of hosts on the network defined by multicast groups. Membership to these multicast groups are established using IGMP/MLD.

Use the **IGMP/MLD** screen to configure IGMP/MLD group settings.

#### 15.1.1 What You Need To Know

##### Multicast and IGMP

See [Multicast on page 236](#) for more information.

##### Multicast Listener Discovery (MLD)

The Multicast Listener Discovery (MLD) protocol (defined in RFC 2710) is derived from IPv4's Internet Group Management Protocol version 2 (IGMPv2). MLD uses ICMPv6 message types, rather than IGMP message types. MLDv1 is equivalent to IGMPv2 and MLDv2 is equivalent to IGMPv3.

- MLD allows an IPv6 switch or router to discover the presence of MLD hosts who wish to receive multicast packets and the IP addresses of multicast groups the hosts want to join on its network.
- MLD snooping and MLD proxy are analogous to IGMP snooping and IGMP proxy in IPv4.
- MLD filtering controls which multicast groups a port can join.
- An MLD Report message is equivalent to an IGMP Report message, and an MLD Done message is equivalent to an IGMP Leave message.

##### IGMP Fast Leave

When a host leaves a multicast group (224.1.1.1), it sends an IGMP leave message to inform all routers (224.0.0.2) in the multicast group. When a router receives the leave message, it sends a specific query message to all multicast group (224.1.1.1) members to check if any other hosts are still in the group. Then the router deletes the host's information.

With the IGMP fast leave feature enabled, the router removes the host's information from the group member list once it receives a leave message from a host and the fast leave timer expires.

### 15.2 The IGMP/MLD Screen

Use this screen to configure multicast groups that the Zyxel Device manages through IGMP/MLD settings. To open this screen, click **Network Setting > IGMP/MLD**.

Note: Some models might only support IGMP/MLD **Default Version** configuration.

**Figure 187** Network Setting > IGMP/MLD

## IGMP/MLD

Enter IGMP/MLD protocol configuration fields if you want modify default values shown below. Please note that if you modify IGMP query interval, MLD query interval will also be changed, and vice versa.

### IGMP Configuration

Default Version	<input type="text" value="3"/>
Query Interval	<input type="text" value="125"/>
Query Response Interval	<input type="text" value="10"/>
Last Member Query Interval	<input type="text" value="10"/>
Robustness Value	<input type="text" value="2"/>
Maximum Multicast Groups	<input type="text" value="25"/>
Maximum Multicast Data Sources(for IGMPv3)	<input type="text" value="10"/>
Maximum Multicast Groups Members	<input type="text" value="25"/>
Fast Leave Enable	<input checked="" type="checkbox"/>
LAN to LAN (Intra LAN) Multicast Enable	<input checked="" type="checkbox"/>
Membership Join Immediate (IPTV)	<input checked="" type="checkbox"/>

### MLD Configuration

Default Version	<input type="text" value="2"/>
Query Interval	<input type="text" value="125"/>
Query Response Interval	<input type="text" value="10"/>
Last Member Query Interval	<input type="text" value="10"/>
Robustness Value	<input type="text" value="2"/>
Maximum Multicast Groups	<input type="text" value="10"/>
Maximum Multicast Data Sources(for IGMPv3)	<input type="text" value="10"/>
Maximum Multicast Groups Members	<input type="text" value="10"/>
Fast Leave Enable	<input checked="" type="checkbox"/>
LAN to LAN (Intra LAN) Multicast Enable	<input checked="" type="checkbox"/>

Cancel
Apply

The following table describes the labels in this screen.

Table 115 Network Setting > IGMP/MLD

LABEL	DESCRIPTION
IGMP/MLD Configuration	
Default Version	Enter the version of IGMP (1~3) and MLD (1~2) that you want the Zyxel Device to use on the WAN.

Table 115 Network Setting &gt; IGMP/MLD (continued)

LABEL	DESCRIPTION
Query Interval	Enter the number of seconds the Zyxel Device sends a query message to hosts to get the group membership information.
Query Response Interval	Enter the maximum number of seconds the Zyxel Device can wait for receiving a General Query message. Multicast routers use general queries to learn which multicast groups have members.
Last Member Query Interval	Enter the maximum number of seconds the Zyxel Device can wait for receiving a response to a Group-Specific Query message. Multicast routers use group-specific queries to learn whether any member remains in a specific multicast group.
Robustness Value	Enter the number of times (1~7) the Zyxel Device can resend a packet if packet loss occurs due to network congestion.
Maximum Multicast Groups	Enter a number to limit the number of multicast groups an interface on the Zyxel Device is allowed to join. Once a multicast member is registered in the specified number of multicast groups, any new IGMP or MLD join report frames are dropped by the interface.
Maximum Multicast Data Sources(for IGMPv3)	Enter a number to limit the number of multicast data sources (1-24) a multicast group is allowed to have.  Note: The setting only works for IGMPv3 and MLDv2.
Maximum Multicast Group Members	Enter a number to limit the number of multicast members a multicast group can have.
Fast Leave Enable	Select this option to set the Zyxel Device to remove a port from the multicast tree immediately (without sending an IGMP or MLD membership query message) once it receives an IGMP or MLD leave message. This is helpful if a user wants to quickly change a TV channel (multicast group change) especially for IPTV applications.
LAN to LAN (Intra LAN) Multicast Enable	Select this to enable LAN to LAN IGMP snooping capability.
Membership Join Immediate (IPTV)	Select this to have the Zyxel Device add a host to a multicast group immediately once the Zyxel Device receives an IGMP or MLD join message.
Cancel	Click <b>Cancel</b> to exit this screen without saving.
Apply	Click <b>Apply</b> to save your changes back to the Zyxel Device.

# CHAPTER 16

## VLAN Group

### 16.1 VLAN Group Overview

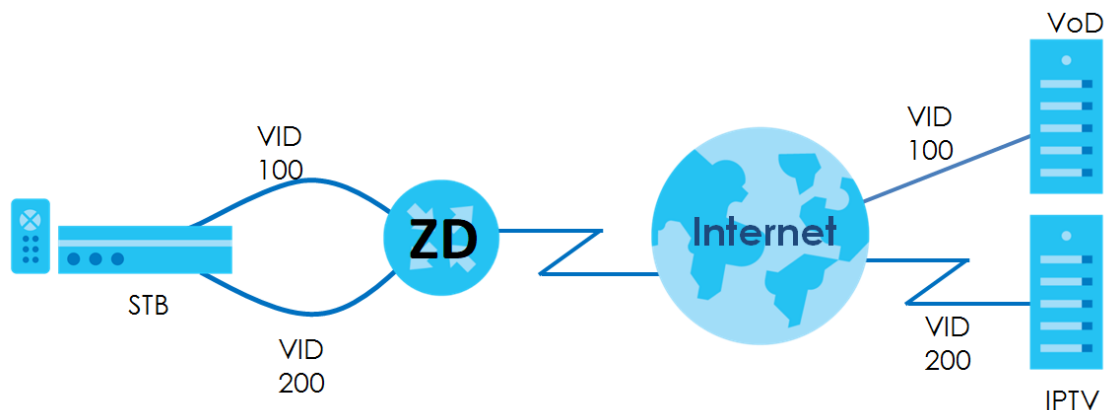
A VLAN (Virtual Local Area Network) allows a physical network to be partitioned into multiple logical networks. Devices on a logical network belong to one group. A device can belong to more than one group. With VLAN, a device cannot directly talk to or hear from devices that are not in the same groups; the traffic must first go through a router.

Ports in the same VLAN group share the same frame broadcast domain thus increase network performance through reduced broadcast traffic. Shared resources such as a server can be used by all ports in the same VLAN as the server. Ports can belong to other VLAN groups too. VLAN groups can be modified at any time by adding, moving or changing ports without any re-cabling.

A tagged VLAN uses an explicit tag (VLAN ID) in the MAC header to identify the VLAN membership of a frame across bridges. The VLAN ID associates a frame with a specific VLAN and provides the information that switches the need to process the frame across the network.

In the following example, VLAN IDs (VIDs) 100 and 200 are added to identify Video-on-Demand and IPTV traffic respectively coming from the VoD and IPTV multicast servers. The Zyxel Device can also tag outgoing requests to the servers with these VLAN IDs.

**Figure 188** VLAN Group Example



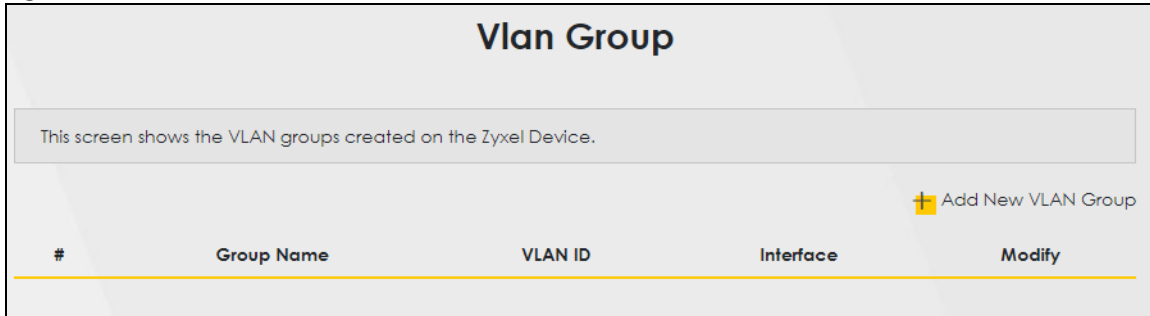
#### 16.1.1 What You Can Do in this Chapter

Use these screens to manage VLAN groups on the Zyxel Device.

## 16.2 VLAN Group Settings

This screen shows the VLAN groups created on the Zyxel Device. Click **Network Setting > VLAN Group** to open the following screen.

**Figure 189** Network Setting > VLAN Group



The following table describes the fields in this screen.

Table 116 Network Setting > VLAN Group

LABEL	DESCRIPTION
Add New VLAN Group	Click this button to create a new VLAN group.
#	This is the index number of the VLAN group.
Group Name	This shows the descriptive name of the VLAN group.
VLAN ID	This shows the unique ID number that identifies the VLAN group.
Interface	This shows the LAN ports included in the VLAN group and if traffic leaving the port will be tagged with the VLAN ID.
Modify	Click the <b>Edit</b> icon to change an existing VLAN group setting or click the <b>Delete</b> icon to remove the VLAN group.

### 16.2.1 Add or Edit a VLAN Group

Click the **Add New VLAN Group** button in the **VLAN Group** screen to open the following screen. Use this screen to create a new VLAN group.

**Figure 190** Network Setting > VLAN Group > Add New VLAN Group/Edit

The following table describes the fields in this screen.

Table 117 Network Setting &gt; VLAN Group &gt; Add New VLAN Group/Edit

LABEL	DESCRIPTION
VLAN ID	Enter a unique ID number, from 1 to 4,094, to identify this VLAN group. Outgoing traffic is tagged with this ID if <b>TX Tagging</b> is selected below.
LAN	Select <b>Include</b> to add the associated LAN interface to this VLAN group.  Note: Select <b>TX Tagging</b> to tag outgoing traffic from the associated LAN port with the <b>VLAN ID</b> number entered above.
	Select <b>Include</b> to add the associated LAN interface to this VLAN group.  Note: Select <b>TX Tagging</b> to tag outgoing traffic from the associated LAN port with the <b>VLAN ID</b> number entered above.
Cancel	Click <b>Cancel</b> to exit this screen without saving any changes.
OK	Click <b>OK</b> to save your changes.



# CHAPTER 17

## Interface Grouping

### 17.1 Interface Grouping Overview

By default, all LAN and WAN interfaces on the Zyxel Device are in the same group and can communicate with each other. Create interface groups to have the Zyxel Device assign IP addresses in different domains to different groups. Each group acts as an independent network on the Zyxel Device. This lets devices connected to an interface group's LAN interfaces communicate through the interface group's WAN or LAN interfaces but not other WAN or LAN interfaces.

#### 17.1.1 What You Can Do in this Chapter

The **Interface Grouping** screen lets you create multiple networks on the Zyxel Device ([Section 17.2 on page 361](#)).

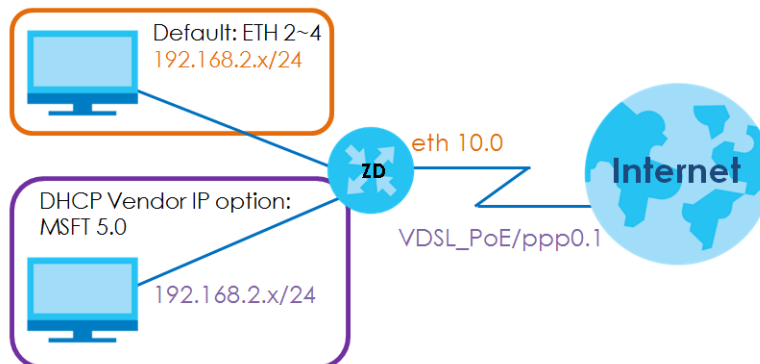
### 17.2 Interface Grouping

You can manually add a LAN interface to a new group. Alternatively, you can have the Zyxel Device automatically add the incoming traffic and the LAN interface on which traffic is received to an interface group when its DHCP Vendor ID option information matches one listed for the interface group.

Use the **LAN Setup** screen to configure the private IP addresses the DHCP server on the Zyxel Device assigns to the clients in the default and/or user-defined groups. If you set the Zyxel Device to assign IP addresses based on the client's DHCP Vendor ID option information, you must enable DHCP server and configure LAN TCP/IP settings for both the default and user-defined groups. See [Chapter 10 on page 271](#) for more information.

In the following example, the client that sends packets with the DHCP Vendor ID option set to MSFT 5.0 (meaning it is a Windows 2000 DHCP client) is assigned the IP address 192.168.2.2 and uses the WAN VDSL\_PoE/ppp0.1 interface.

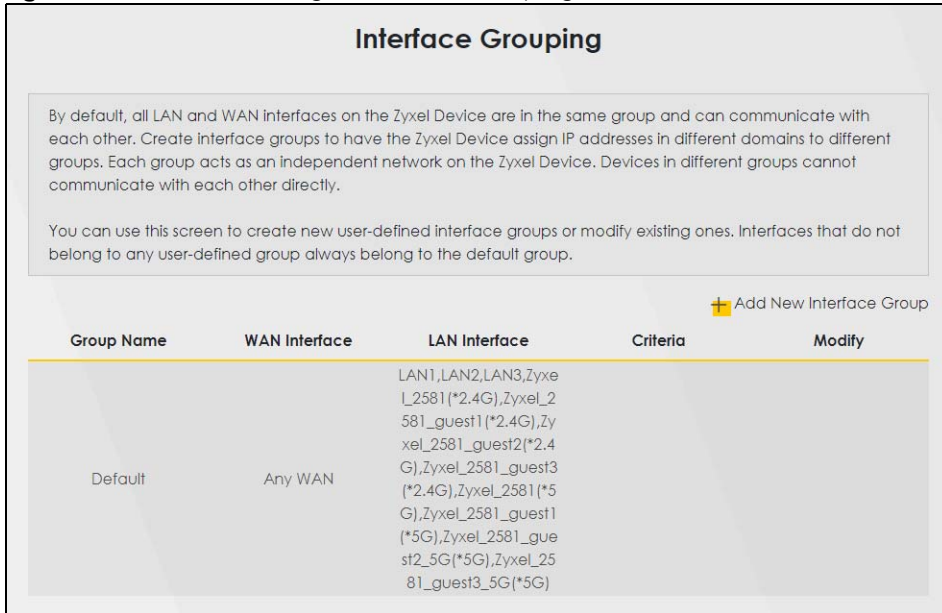
**Figure 191** Interface Grouping Application



You can use this screen to create new user-defined interface groups or modify existing ones. Interfaces that do not belong to any user-defined group always belong to the default group.

Click **Network Setting > Interface Grouping** to open the following screen.

**Figure 192** Network Setting > Interface Grouping



The following table describes the fields in this screen.

Table 118 Network Setting > Interface Grouping

LABEL	DESCRIPTION
Add New Interface Group	Click this button to create a new interface group.
Group Name	This shows the descriptive name of the group.
WAN Interface	This shows the WAN interfaces in the group.
LAN Interfaces	This shows the LAN interfaces in the group.
Criteria	This shows the filtering criteria for the group.
Modify	Click the <b>Edit</b> icon to modify an existing Interface group setting or click the <b>Delete</b> icon to remove the Interface group.

## 17.2.1 Interface Group Configuration

Click the **Add New Interface Group** button in the **Interface Grouping** screen to open the following screen. Use this screen to create a new interface group. If you want to automatically add LAN clients to a new group, use filtering criteria.

Note: An interface can belong to only one group at a time.

Note: After configuring a vendor ID, reboot the client device attached to the Zyxel Device to obtain an appropriate IP address.

Note: You can have up to 15 filter criteria.

**Figure 193** Network Setting > Interface Grouping > Add New Interface Group (for DSL routers)

<

### Add New Interface Group

Use this screen to create a new interface group. If you want to automatically add LAN clients to a new group, use filtering criteria.

Group Name

WAN Interfaces used in the grouping

PTM type-  ▼

ATM type-  ▼

ETH type-  ▼

WWAN type-  ▼

**# Available LAN Interfaces**

- LAN1
- LAN2
- LAN3
- LAN4
- ZyxeL\_0002(\*2.4G)

>

<

**# Selected LAN Interfaces**

- 
- 
-

**Automatically Add Clients With the following DHCP Vendor IDs**

#	Filter Criteria	WildCard Support	Modify
1	Option 60: 55	Y	✎ 🗑

+ Add

Note

(1) After configuring a vendor ID, reboot the client device attached to the Zyxel Device to obtain an appropriate IP address.

(2) You can have up to 15 filter criteria.

Cancel OK

**Figure 194** Network Setting > Interface Grouping > Add New Interface Group (for Ethernet routers)

<

### Add New Interface Group

Use this screen to create a new interface group. If you want to automatically add LAN clients to a new group, use filtering criteria.

Group Name

WAN Interfaces used in the grouping

ETH type-

WWAN type-

**# Available LAN Interfaces**

- LAN1
- LAN2
- LAN3
- LAN4
- Zyxel\_0002(\*2.4G)

>

<

**# Selected LAN Interfaces**

**Automatically Add Clients With the following DHCP Vendor IDs**

#	Filter Criteria	WildCard Support	Modify
+			Add

Note

(1) After configuring a vendor ID, reboot the client device attached to the Zyxel Device to obtain an appropriate IP address.

(2) You can have up to 15 filter criteria.

Cancel
OK

**Figure 195** Network Setting > Interface Grouping > Add New Interface Group (for AON and PON routers)

The following table describes the fields in this screen.

Table 119 Network Setting > Interface Grouping > Add New Interface Group/Edit

LABEL	DESCRIPTION
Group Name	Enter a descriptive name for this interface group. You can use up to 32 printable characters except [ " ], [ ` ], [ ' ], [ < ], [ > ], [ ^ ], [ \$ ], [   ], [ & ], or [ ; ]. Spaces are allowed.
WAN Interfaces used in the grouping	Select the WAN interface this group uses. The group can have up to one PTM interface, up to one ATM interface, up to one ETH interface, and up to one WWAN interface. Select <b>None</b> to not add a WAN interface to this group.
Selected LAN Interfaces	Select one or more interfaces (Ethernet LAN, wireless LAN) in the <b>Available LAN Interfaces</b> list and use the left arrow to move them to the <b>Selected LAN Interfaces</b> list to add the interfaces to this group.
Available LAN Interfaces	To remove a LAN or wireless LAN interface from the <b>Selected LAN Interfaces</b> , use the right-facing arrow.

Table 119 Network Setting &gt; Interface Grouping &gt; Add New Interface Group/Edit (continued)

LABEL	DESCRIPTION
Automatically Add Clients With the following DHCP Vendor IDs	Click <b>Add</b> to identify LAN hosts to add to the interface group by criteria such as the type of the hardware or firmware. See <a href="#">Section 17.2.2 on page 366</a> for more information.
#	This shows the index number of the rule.
Filter Criteria	This shows the filtering criteria. The LAN interface on which the matched traffic is received will belong to this group automatically.
Wildcard Support	This shows if wildcard on DHCP option 60 is enabled.
Modify	Click the <b>Edit</b> icon to change the group setting. Click the <b>Delete</b> icon to delete this group from the Zyxel Device.
Cancel	Click <b>Cancel</b> to exit this screen without saving.
OK	Click OK to save your changes.

## 17.2.2 Interface Grouping Criteria

Click the **Add** button in the **Interface Grouping Configuration** screen to open the following screen. Use this screen to automatically add clients to an interface group based on specified criteria. You can choose to define a group based on a MAC address, a vendor ID (DHCP option 60), an Identity Association Identifier (DHCP option 61), vendor specific information (DHCP option 125), or a VLAN group.

Figure 196 Network Setting &gt; Interface Grouping &gt; Interface Group Configuration: Add

**Criteria**

Source MAC address  
 APAS MAC Filter  
 DHCP option 60  
 DHCP option 61  
 DHCP option 125  
 VLAN Group

Enterprise Number

Manufacturer OUI

Serial Number

Product Class

Cancel OK

The following table describes the fields in this screen.

Table 120 Network Setting > Interface Grouping > Interface Group Configuration: Add

LABEL	DESCRIPTION
Source MAC Address	Enter the source MAC address of the packet.
APAS MAC Filter	Select this option and enter the MAC address of the matched LAN host.
DHCP Option 60	Select this option and enter the Vendor Class Identifier (Option 60) of the matched traffic, such as the type of the hardware or firmware.
Enable wildcard	Select this option to be able to use wildcards in the Vendor Class Identifier configured for DHCP option 60.
DHCP Option 61	Select this and enter the device identity of the matched traffic.
	Enter the Identity Association Identifier (IAID) of the device, for example, the WAN connection index number.
DHCP Option 125	Select this and enter vendor specific information of the matched traffic.
Enterprise Number	Enter the vendor's 32-bit enterprise number registered with the IANA (Internet Assigned Numbers Authority).
Manufacturer OUI	Specify the vendor's OUI (Organization Unique Identifier). It is usually the first 3 bytes of the MAC address.
Serial Number	Enter the serial number of the device.
Product Class	Enter the product class of the device.
VLAN Group	Select this and the VLAN group of the matched traffic from the drop-down list box. A VLAN group can be configured in <b>Network Setting &gt; VLAN Group</b> .
Cancel	Click <b>Cancel</b> to exit this screen without saving.
OK	Click <b>OK</b> to save your changes.

# CHAPTER 18

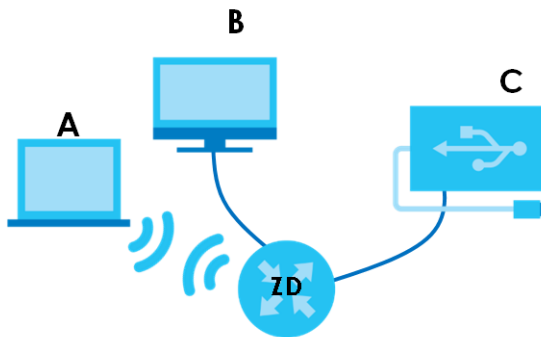
## USB Service

### 18.1 USB Service Overview

You can share files on a USB memory stick or hard drive connected to your Zyxel Device with users on your network.

The following figure is an overview of the Zyxel Device's file server feature. Computers **A** and **B** can access files on a USB device (**C**) which is connected to the Zyxel Device.

**Figure 197** File Sharing Overview



The Zyxel Device will not be able to join a workgroup if your local area network has restrictions set up that do not allow devices to join a workgroup. In this case, contact your network administrator.

#### 18.1.1 What You Can Do in this Chapter

- Use the **File Sharing** screen to enable file-sharing server ([Section 18.2 on page 369](#)).
- Use the **Media Server** screen to enable or disable the sharing of media files ([Section 18.3 on page 372](#)).

#### 18.1.2 What You Need To Know

The following terms and concepts may help as you read this chapter.

##### 18.1.2.1 About File Sharing

###### Workgroup Name

This is the name given to a set of computers that are connected on a network and share resources such as a printer or files. Windows automatically assigns the workgroup name when you set up a network.



## Shares

When settings are set to default, each USB device connected to the Zyxel Device is given a folder, called a "share". If a USB hard drive connected to the Zyxel Device has more than one partition, then each partition will be allocated a share. You can also configure a "share" to be a sub-folder or file on the USB device.

## File Systems

A file system is a way of storing and organizing files on your hard drive and storage device. Often different operating systems such as Windows or Linux have different file systems. The file sharing feature on your Zyxel Device supports File Allocation Table (FAT) and FAT32.

## Common Internet File System

The Zyxel Device uses Common Internet File System (CIFS) protocol for its file sharing functions. CIFS compatible computers can access the USB file storage devices connected to the Zyxel Device. CIFS protocol is supported on Microsoft Windows, Linux Samba and other operating systems (refer to your systems specifications for CIFS compatibility).

### 18.1.3 Before You Begin

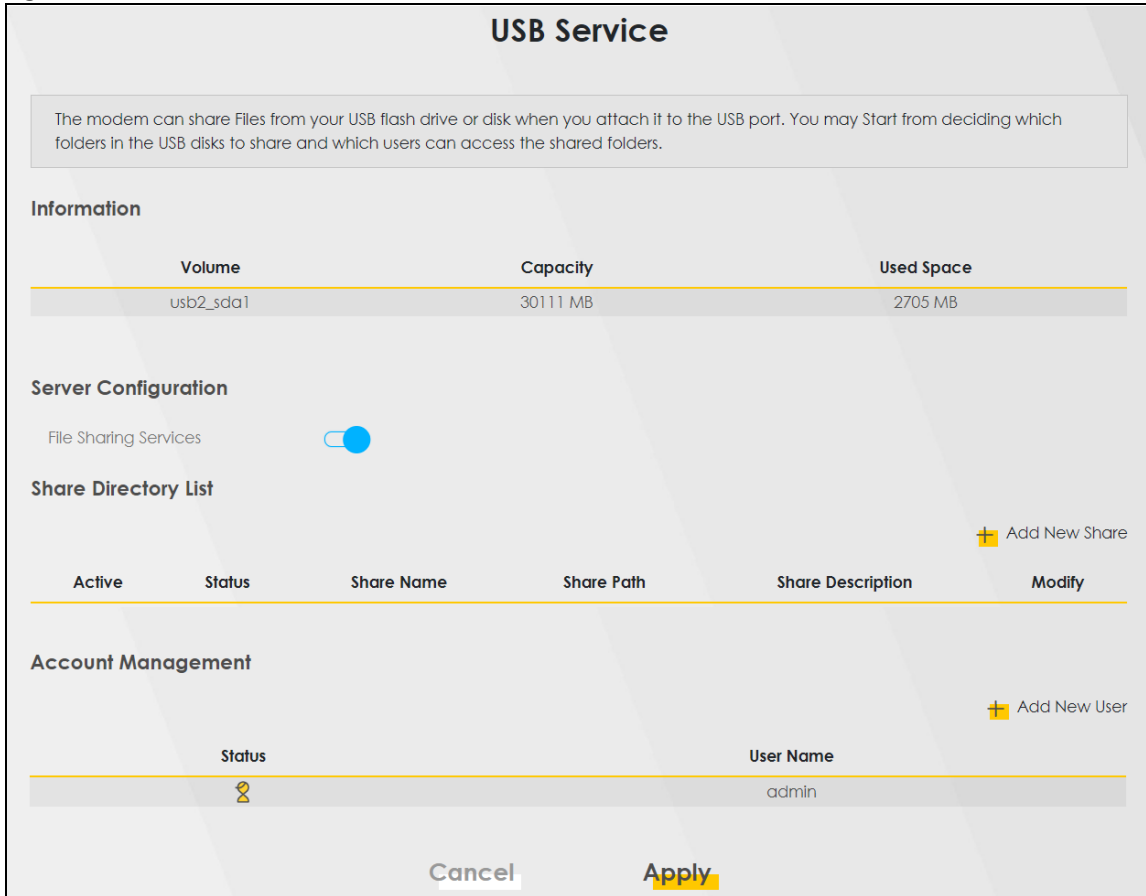
- 1 Make sure the Zyxel Device is connected to your network and turned on.
- 2 Connect the USB device to one of the Zyxel Device's USB port. If you are connecting a USB hard drive that comes with an external power supply, make sure it is connected to an appropriate power source.
- 3 The Zyxel Device detects the USB device and makes its contents available for browsing.

Note: If your USB device cannot be detected by the Zyxel Device, see the troubleshooting for suggestions.

## 18.2 USB Service

Use this screen to set up file sharing through the Zyxel Device. The Zyxel Device's LAN users can access the shared folder (or share) from the USB device inserted in the Zyxel Device. To access this screen, click **Network Setting > USB Service**.

Figure 198 Network Setting > USB Service



Note: The **Share Directory List** is only visible when you connect a USB device.

Each field is described in the following table.

Table 121 Network Setting > USB Service

LABEL	DESCRIPTION
Information	
Volume	This is the volume name the Zyxel Device gives to an inserted USB device.
Capacity	This is the total available memory size (in megabytes) on the USB device.
Used Space	This is the memory size (in megabytes) already used on the USB device.
Server Configuration	
File Sharing Services	Click this switch to enable file sharing through the Zyxel Device.
Share Directory List	
This only appears when you have inserted a USB device.	
Add New Share	Click this to set up a new share on the Zyxel Device.
Active	Select this to allow the share to be accessed.
Status	This field shows the status of the share : The share is not activated. : The share is activated.

Table 121 Network Setting &gt; USB Service (continued)

LABEL	DESCRIPTION
Share Name	This field displays the name of the file you shared.
Share Path	This field displays the location in the USB of the file you shared.
Share Description	This field displays a description of the file you shared.
Modify	Click the <b>Edit</b> icon to change the settings of an existing share. Click the <b>Delete</b> icon to delete this share in the list.
Account Management	
Add New User	Click this button to create a user account to access the secured shares. This button redirects you to <b>Maintenance &gt; User Account</b> .
Status	This field shows the status of the user. : The user account is not activated for the share. 🔒: The user account is activated for the share.
User Name	This is the name of a user who is allowed to access the secured shares on the USB device.
Cancel	Click this to restore your previously saved settings.
Apply	Click this to save your changes to the Zyxel Device.

## 18.2.1 Add New Share

Use this screen to set up a new share or edit an existing share on the Zyxel Device. Click **Add New Share** in the **File Sharing** screen or click the **Edit** or **Modify** icon next to an existing share.

Please note that you need to set up shared folders on the USB device before enabling file sharing in the Zyxel Device. Spaces and the following special characters, [ " ], [ ` ], [ ' ], [ < ], [ > ], [ ^ ], [ \$ ], [ | ], [ & ], [ ; ], are not allowed for the USB share name.

Figure 199 Network Setting &gt; USB Service &gt; Add New Share

The screenshot shows the 'Add New Share' configuration screen. It includes the following elements:

- Volume:** A dropdown menu showing 'usb1\_sda1'.
- Share Path:** A text input field with a yellow 'Browse' button to its right.
- Description:** A text input field.
- Access Level:** A dropdown menu showing 'Security'.
- Allowed:** A checkbox that is currently unchecked.
- User Name:** A text input field containing 'admin'.
- Buttons:** 'Cancel' and 'OK' buttons at the bottom of the screen.

The following table describes the labels in this menu.

Table 122 Network Setting > USB Service > Add New Share

LABEL	DESCRIPTION
Volume	Select the volume in the USB storage device that you want to add as a share in the Zyxel Device.  This field is read-only when you are editing the share.
Share Path	Manually enter the file path for the share, or click the <b>Browse</b> button and select the folder that you want to add as a share.  This field is read-only when you are editing the share.
Description	You can either enter a short description of the share, or leave this field blank. You can use up to 128 printable characters except [ " ], [ ` ], [ ' ], [ < ], [ > ], [ ^ ], [ \$ ], [   ], [ & ], or [ ; ]. Spaces are allowed.
Access Level	Select <b>Public</b> if you want the share to be accessed by users connecting to the Zyxel Device. Otherwise, select <b>Security</b> .
Allowed	If <b>Security</b> is selected in the <b>Access Level</b> field, select this check box to allow/prohibit access to the share.
User Name	This field specifies the user for which the <b>Allowed</b> setting applies. Users can be added or modified in <b>Maintenance &gt; User Account</b> .
Cancel	Click <b>Cancel</b> to return to the previous screen.
OK	Click <b>OK</b> to save your changes.

## 18.2.2 Add New User Screen

Once you click the **Add New User** button, you'll be directed to the **User Account** screen. To create a user account that can access the secured shares on the USB device, click the **Add New Account** button in the **Network Setting > USB Service > User Account** screen.

Please see [Chapter 36 on page 468](#), for detailed information about **User Account** screen.

## 18.3 Media Server

The media server feature lets anyone on your network play video, music, and photos from the USB storage device connected to your Zyxel Device without having to copy them to another computer. The Zyxel Device can function as a DLNA-compliant media server, where the Zyxel Device streams files to DLNA-compliant media clients like Windows Media Player. The Digital Living Network Alliance (DLNA) is a group of personal computer and electronics companies that works to make products compatible in a home network.

The Zyxel Device media server enables you to:

- Publish all shares for everyone to play media files in the USB storage device connected to the Zyxel Device.
- Use hardware-based media clients like the DMA-2500 to play the files.

Note: Anyone on your network can play the media files in the published shares. No user name and password or other form of security is used. The media server is enabled by default with the video, photo, and music shares published.

To change your Zyxel Device's media server settings, click **Network Setting > USB Service > Media Server**. The screen appears as shown.

**Figure 200** Network Setting > USB Service > Media Server

**USB Service**

File Sharing **Media Server**

The media server feature lets anyone on your network play video, music, and photos from the USB storage device connected to your Zyxel Device without having to copy them to another computer. The Zyxel Device can function as a DLNA-compliant media server, where the Zyxel Device streams files to DLNA-compliant media clients like Windows Media Player. The Digital Living Network Alliance (DLNA) is a group of personal computer and electronics companies that works to make products compatible in a home network.

Media Server


Interface

Volume

Media Library Path

The following table describes the labels in this menu.

**Table 123** Network Setting > USB Service > Media Server

LABEL	DESCRIPTION
Media Server	Click this switch to have the Zyxel Device function as a DLNA-compliant media server. When the switch goes to the right  , the function is enabled. Otherwise, it is not. Enable the media server to let (DLNA-compliant) media clients on your network play media files located in the shares.
Interface	Select an interface on which you want to enable the media server function. An interface can be added or modified in <b>Network Setting &gt; Interface Grouping</b> .
Volume	This is the volume name the Zyxel Device gives to an inserted USB device. Select a volume in the USB storage device(s) to allow the Zyxel Device media server access. Select <b>All USB Devices</b> to enable access on all volumes.
Media Library Path	Enter the path clients use to access the media files on a USB storage device connected to the Zyxel Device.
Cancel	Click <b>Cancel</b> to restore your previously saved settings.
Apply	Click <b>Apply</b> to save your changes.

# CHAPTER 19

## Firewall

### 19.1 Firewall Overview

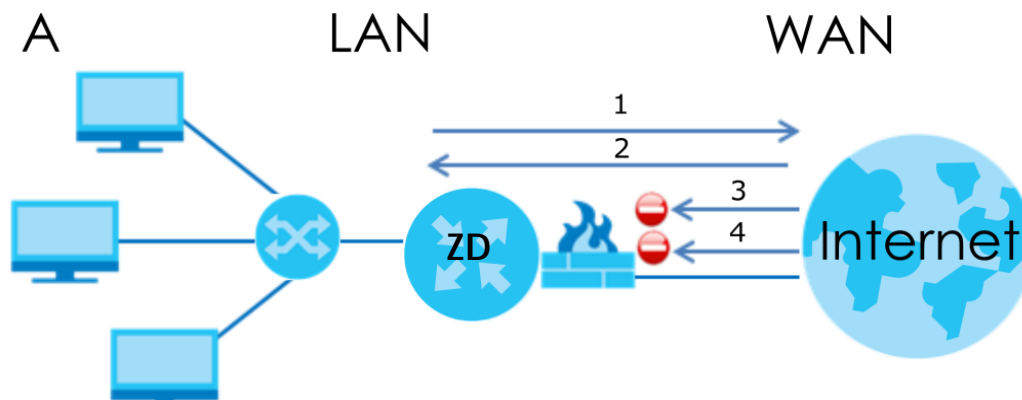
This chapter shows you how to enable the Zyxel Device firewall. Use the firewall to protect your Zyxel Device and network from attacks by hackers on the Internet and control access to it. The firewall:

- allows traffic that originates from your LAN computers to go to all other networks.
- blocks traffic that originates on other networks from going to the LAN.

By default, the Zyxel Device blocks DoS attacks whether the firewall is enabled or disabled.

The following figure illustrates the firewall action. User **A** can initiate an IM (Instant Messaging) session from the LAN to the WAN (1). Return traffic for this session is also allowed (2). However other traffic initiated from the WAN is blocked (3 and 4).

Figure 201 Default Firewall Action



#### 19.1.1 What You Need to Know About Firewall

##### SYN Attack

A SYN attack floods a targeted system with a series of SYN packets. Each packet causes the targeted system to issue a SYN-ACK response. While the targeted system waits for the ACK that follows the SYN-ACK, it queues up all outstanding SYN-ACK responses on a backlog queue. SYN-ACKs are moved off the queue only when an ACK comes back or when an internal timer terminates the three-way handshake. Once the queue is full, the system will ignore all incoming SYN requests, making the system unavailable for legitimate users.

## DoS

Denial-of-Service (DoS) attacks are aimed at devices and networks with a connection to the Internet. Their goal is not to steal information, but to disable a device or network so users no longer have access to network resources. The Zyxel Device is pre-configured to automatically detect and thwart all known DoS attacks.

## DoS Thresholds

For DoS attacks, the Zyxel Device uses thresholds to determine when to drop sessions that do not become fully established. These thresholds apply globally to all sessions. You can use the default threshold values, or you can change them to values more suitable to your security requirements.

## DDoS

A Distributed Denial-of-Service (DDoS) attack is one in which multiple compromised systems attack a single target, thereby causing denial of service for users of the targeted system.

## ICMP

Internet Control Message Protocol (ICMP) is a message control and error-reporting protocol between a host server and a gateway to the Internet. ICMP uses Internet Protocol (IP) datagrams, but the messages are processed by the TCP/IP software and directly apparent to the application user.

## LAND Attack

In a LAND attack, hackers flood SYN packets into the network with a spoofed source IP address of the target system. This makes it appear as if the host computer sent the packets to itself, making the system unavailable while the target system tries to respond to itself.

## Ping of Death

Ping of Death uses a 'ping' utility to create and send an IP packet that exceeds the maximum 65,536 bytes of data allowed by the IP specification. This may cause systems to crash, hang or reboot.

## SPI

Stateful Packet Inspection (SPI) tracks each connection crossing the firewall and makes sure it is valid. Filtering decisions are based not only on rules but also context. For example, traffic from the WAN may only be allowed to cross the firewall in response to a request from the LAN.

## 19.2 Firewall

Use the firewall to protect your Zyxel Device and network from attacks by hackers on the Internet and control access to it.

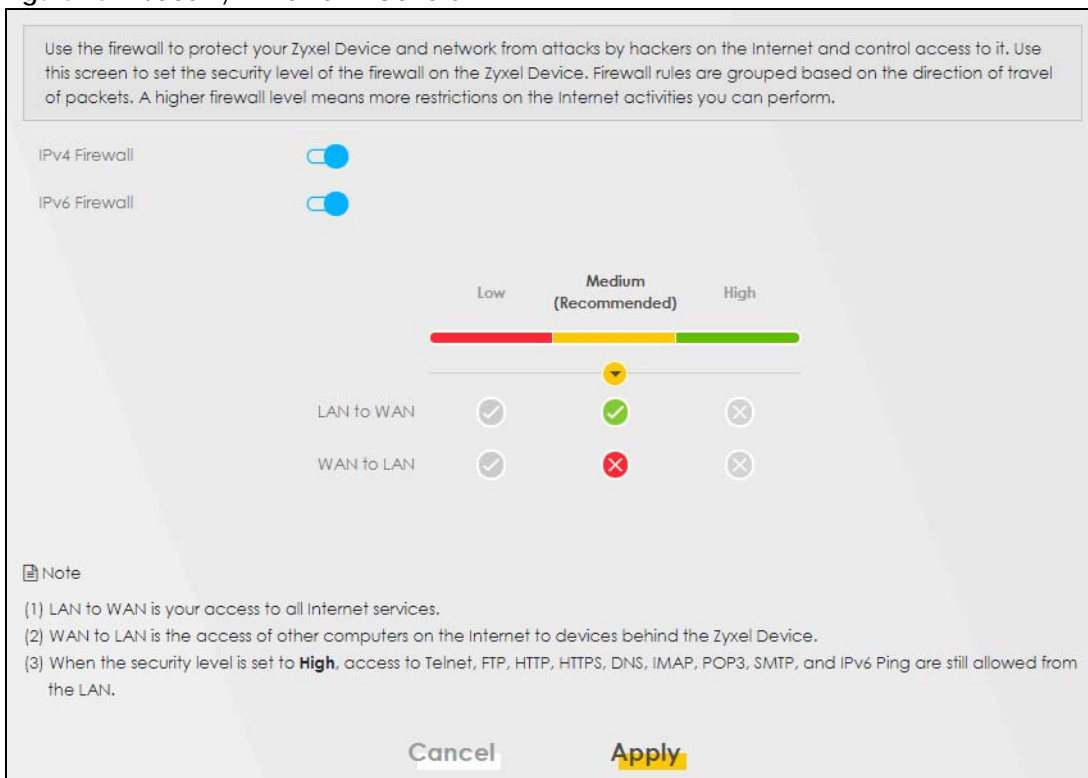
## 19.2.1 What You Can Do in this Chapter

- Use the **General** screen to configure the security level of the firewall on the Zyxel Device ([Section 19.3 on page 376](#)).
- Use the **Protocol** screen to add or remove predefined Internet services and configure firewall rules ([Section 19.4 on page 377](#)).
- Use the **Access Control** screen to view and configure incoming or outgoing filtering rules ([Section 19.5 on page 378](#)).
- Use the **DoS** screen to activate protection against Denial of Service (DoS) attacks ([Section 19.6 on page 381](#)).

## 19.3 Firewall General Settings

Use the firewall to protect your Zyxel Device and network from attacks by hackers on the Internet and control access to it. Use this screen to set the security level of the firewall on the Zyxel Device. Firewall rules are grouped based on the direction of travel of packets. A higher firewall level means more restrictions on the Internet activities you can perform. Click **Security > Firewall > General** to display the following screen. Use the slider to select the level of firewall protection.

**Figure 202** Security > Firewall > General



Note: LAN to WAN is your access to all Internet services. WAN to LAN is the access of other computers on the Internet to devices behind the Zyxel Device. When the security level is set to **High**, Telnet, FTP, HTTP, HTTPS, DNS, IMAP, POP3, SMTP, and/or IPv6 ICMPv6 (Ping) traffic from the LAN are still allowed.



The following table describes the labels in this screen.

Table 124 Security > Firewall > General

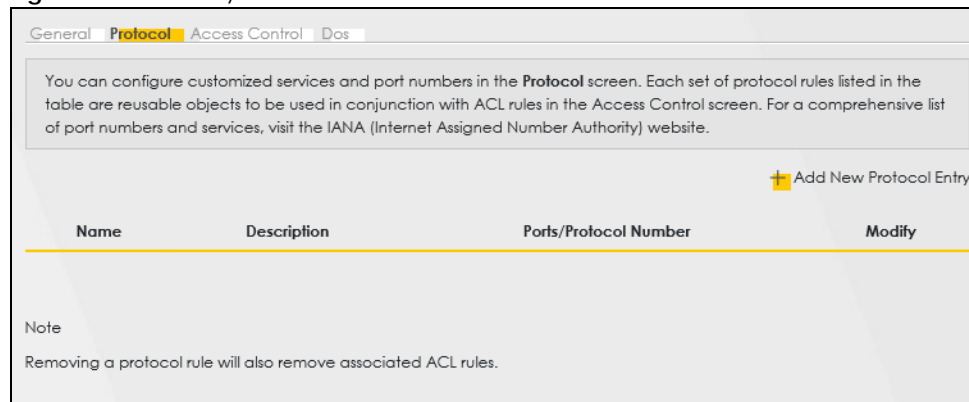
LABEL	DESCRIPTION
IPv4 Firewall	Enable firewall protection when using <b>IPv4</b> (Internet Protocol version 4).
IPv6 Firewall	Enable firewall protection when using <b>IPv6</b> (Internet Protocol version 6).
High	This setting blocks all traffic to and from the Internet. Only local network traffic and LAN to WAN service (Telnet, FTP, HTTP, HTTPS, DNS, POP3, SMTP) is permitted.
Medium	This is the recommended setting. It allows traffic to the Internet but blocks anyone from the Internet from accessing any services on your local network.
Low	This setting allows traffic to the Internet and also allows someone from the Internet to access services on your local network. This would be used with Port Forwarding, Default Server.
Apply	Click this to save your changes.
Cancel	Click this to restore your previously saved settings.

## 19.4 Protocol (Customized Services)

You can configure customized services and port numbers in the **Protocol** screen. Each set of protocol rules listed in the table are reusable objects to be used in conjunction with ACL rules in the Access Control screen. For a comprehensive list of port numbers and services, visit the IANA (Internet Assigned Number Authority) website. Click **Security > Firewall > Protocol** to display the following screen.

Note: Removing a protocol rule will also remove associated ACL rules.

Figure 203 Security > Firewall > Protocol



The following table describes the labels in this screen.

Table 125 Security > Firewall > Protocol

LABEL	DESCRIPTION
Add New Protocol Entry	Click this to configure a customized service.
Name	This is the name of your customized service.
Description	This is a description of your customized service.

Table 125 Security &gt; Firewall &gt; Protocol (continued)

LABEL	DESCRIPTION
Ports/Protocol Number	This shows the port number or range and the IP protocol ( <b>TCP</b> or <b>UDP</b> ) that defines your customized service.
Modify	Click this to edit a customized service.

## 19.4.1 Add Customized Service

Add a customized rule or edit an existing rule by specifying the protocol and the port numbers. Click **Add New Protocol Entry** in the **Protocol** screen to display the following screen.

Figure 204 Security &gt; Firewall &gt; Protocol: Add New Protocol Entry

The following table describes the labels in this screen.

Table 126 Security &gt; Firewall &gt; Protocol: Add New Protocol Entry

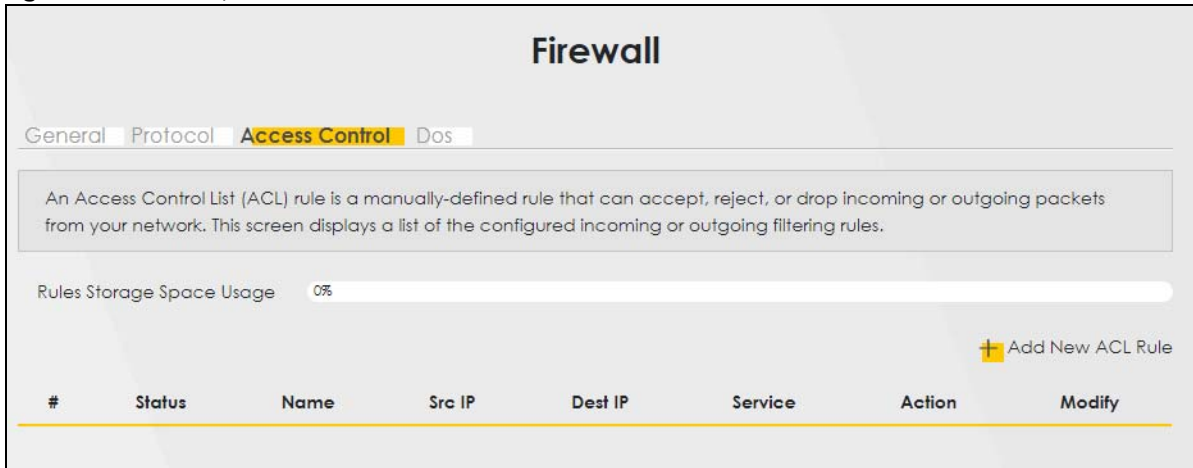
LABEL	DESCRIPTION
Service Name	Enter a descriptive name for your customized service. You can use up to 16 printable characters except [ " ], [ ` ], [ ' ], [ < ], [ > ], [ ^ ], [ \$ ], [   ], [ & ], or [ ; ]. Spaces are allowed.
Description	Enter a description for your customized service. You can use up to 16 printable characters except [ " ], [ ` ], [ ' ], [ < ], [ > ], [ ^ ], [ \$ ], [   ], [ & ], or [ ; ]. Spaces are allowed.
Protocol	Select the protocol ( <b>TCP</b> , <b>UDP</b> , <b>ICMP</b> , <b>ICMPv6</b> , or <b>Other</b> ) that defines your customized port from the drop down list box.
Protocol Number	Enter a single port number or the range of port numbers ( <b>0 – 255</b> ) that define your customized service.
OK	Click this to save your changes.
Cancel	Click this to exit this screen without saving.

## 19.5 Access Control (Rules)

An Access Control List (ACL) rule is a manually-defined rule that can accept, reject, or drop incoming or outgoing packets from your network. This screen displays a list of the configured incoming or outgoing filtering rules. Note the order in which the rules are listed. Click **Security > Firewall > Access Control** to display the following screen.

Note: The ordering of your rules is very important as rules are applied in turn.

**Figure 205** Security > Firewall > Access Control



The following table describes the labels in this screen.

**Table 127** Security > Firewall > Access Control

LABEL	DESCRIPTION
Rules Storage Space Usage	This read-only bar shows how much of the Zyxel Device's memory is in use for recording firewall rules. When you are using 80% or less of the storage space, the bar is green. When the amount of space used is over 80%, the bar is red.
Add New ACL Rule	Select an index number and click <b>Add New ACL Rule</b> to add a new firewall rule after the selected index number. For example, if you select "6", your new rule becomes number 7 and the previous rule 7 (if there is one) becomes rule 8.
#	This field displays the rule index number. The ordering of your rules is important as rules are applied in turn.
Status	This field displays the status of the ACL rule. A yellow bulb signifies that this ACL rule is active, while a gray bulb signifies that this ACL rule is not active.
Name	This field displays the rule name.
Src IP	This field displays the source IP addresses to which this rule applies.
Dest IP	This field displays the destination IP addresses to which this rule applies.
Service	This field displays the protocol (All, TCP, UDP, TCP/UDP, ICMP, ICMPv6, or any) used to transport the packets for which you want to apply the rule.
Action	Displays whether the firewall silently discards packets ( <b>Drop</b> ), discards packets and sends a TCP reset packet or an ICMP destination-unreachable message to the sender ( <b>Reject</b> ), or allow the passage of ( <b>Accept</b> ) packets that match this rule.
Modify	Click the <b>Edit</b> icon to edit the firewall rule.  Click the <b>Delete</b> icon to delete an existing firewall rule.

## 19.5.1 Add New ACL Rule

Click **Add new ACL rule** or the **Edit** icon next to an existing ACL rule in the **Access Control** screen. The following screen displays. Use this screen to accept, reject, or drop packets based on specified parameters, such as source and destination IP address, IP Type, service, and direction. You can also specify a limit as to how many packets this rule applies to at a certain period of time or specify a schedule for this rule.

**Figure 206** Security > Firewall > Access Control > Add New ACL Rule

The following table describes the labels in this screen.

**Table 128** Security > Firewall > Access Control > Add New ACL Rule

LABEL	DESCRIPTION
Active	Click this switch to enable this ACL rule.
Filter Name	Enter a descriptive name for your filter rule. You can use up to 16 printable characters except [ " ], [ ` ], [ ' ], [ < ], [ > ], [ ^ ], [ \$ ], [   ], [ & ], or [ ; ]. Spaces are allowed.
Order	Assign the order of your rules as rules are applied in turn.
Select Source IP Address	If you want the source to come from a particular (single) IP, select <b>Specific IP Address</b> . If not, select from a detected device.
Source IP Address	If you selected <b>Specific IP Address</b> in the previous item, enter the source device's IP address here. Otherwise this field will be hidden if you select the detected device.
Select Destination Device	If you want your rule to apply to packets with a particular (single) IP, select <b>Specific IP Address</b> . If not, select a detected device.
Destination IP Address	If you selected <b>Specific IP Address</b> in the previous item, enter the destination device's IP address here. Otherwise this field will be hidden if you select the detected device.

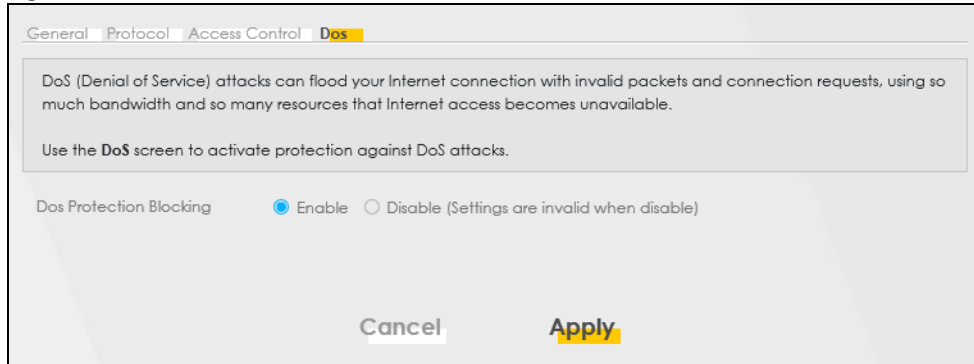
Table 128 Security &gt; Firewall &gt; Access Control &gt; Add New ACL Rule (continued)

LABEL	DESCRIPTION
MAC Address	Enter the MAC addresses of the WiFi or wired LAN clients that are allowed access to the Zyxel Device in these address fields. Enter the MAC addresses in a valid MAC address format, that is, six hexadecimal character pairs, for example, 12:34:56:78:9a:bc.
IP Type	Select between <b>IPv4</b> or <b>IPv6</b> . Compared to <b>IPv4</b> , <b>IPv6</b> (Internet Protocol version 6), is designed to enhance IP address size and features. The increase in <b>IPv6</b> address size to 128 bits (from the 32-bit <b>IPv4</b> address) allows up to 3.4 x 10 <sup>38</sup> IP addresses. The Zyxel Device can use <b>IPv4/IPv6</b> dual stack to connect to <b>IPv4</b> and <b>IPv6</b> networks, and supports <b>IPv6</b> rapid deployment (6RD).
Select Service	Select a service from the <b>Select Service</b> box.
Protocol	Select the protocol ( <b>ALL</b> , <b>TCP/UDP</b> , <b>TCP</b> , <b>UDP</b> , <b>ICMP</b> , or <b>ICMPv6</b> ) used to transport the packets for which you want to apply the rule.
Custom Source Port	This is a single port number or the starting port number of a range that defines your rule.
Custom Destination Port	This is a single port number or the ending port number of a range that defines your rule.
TCP Flag	Select the TCP Flag (SYN, ACK, URG, PSH, RST, FIN).  This appears when you select <b>TCP/UDP</b> or <b>TCP</b> in the <b>Protocol</b> field.
Policy	Use the drop-down list box to select whether to discard ( <b>Drop</b> ), deny and send an ICMP destination-unreachable message to the sender ( <b>Reject</b> ), or allow the passage of ( <b>Accept</b> ) packets that match this rule.
Direction	Select <b>WAN to LAN</b> to apply the rule to traffic from WAN to LAN. Select <b>LAN to WAN</b> to apply the rule to traffic from LAN to WAN. Select <b>WAN to Router</b> to apply the rule to traffic from WAN to router. Select <b>LAN to Router</b> to apply the rule to traffic from LAN to router.
Enable Rate Limit	Click this switch to enable the setting of maximum number of packets per maximum number of minute or second to limit the throughput of traffic that matches this rule. If not, the next item will be disabled.
Scheduler Rules	Select a schedule rule for this ACL rule form the drop-down list box. You can configure a new schedule rule by clicking <b>Add New Rule</b> . This will bring you to the <b>Security &gt; Scheduler Rules</b> screen.
OK	Click this to save your changes.
Cancel	Click this to exit this screen without saving.

## 19.6 DoS

DoS (Denial of Service) attacks can flood your Internet connection with invalid packets and connection requests, using so much bandwidth and so many resources that Internet access becomes unavailable. Use the **DoS** screen to activate protection against DoS attacks.

Click **Security > Firewall > DoS** to display the following screen.

**Figure 207** Security > Firewall > DoS

The following table describes the labels in this screen.

Table 129 Security &gt; Firewall &gt; DoS

LABEL	DESCRIPTION
DoS Protection Blocking	Enable this to protect against DoS attacks. The Zyxel Device will drop sessions that surpass maximum thresholds.
Apply	Click this to save your changes.
Cancel	Click this to restore your previously saved settings.

## 19.7 Firewall Technical Reference

This section provides some technical background information about the topics covered in this chapter.

### 19.7.1 Firewall Rules Overview

Your customized rules take precedence and override the Zyxel Device's default settings. The Zyxel Device checks the source IP address, destination IP address and IP protocol type of network traffic against the firewall rules (in the order you list them). When the traffic matches a rule, the Zyxel Device takes the action specified in the rule.

Firewall rules are grouped based on the direction of travel of packets to which they apply:

- LAN to Router
- LAN to WAN
- WAN to LAN
- WAN to Router

By default, the Zyxel Device's stateful packet inspection allows packets traveling in the following directions:

- LAN to Router
  - These rules specify which computers on the LAN can manage the Zyxel Device (remote management).

Note: You can also configure the remote management settings to allow only a specific computer to manage the Zyxel Device.

- LAN to WAN

These rules specify which computers on the LAN can access which computers or services on the WAN.

By default, the Zyxel Device's stateful packet inspection drops packets traveling in the following directions:

- WAN to LAN

These rules specify which computers on the WAN can access which computers or services on the LAN.

Note: You also need to configure NAT port forwarding (or full featured NAT address mapping rules) to allow computers on the WAN to access devices on the LAN.

- WAN to Router

By default the Zyxel Device stops computers on the WAN from managing the Zyxel Device. You could configure one of these rules to allow a WAN computer to manage the Zyxel Device.

Note: You also need to configure the remote management settings to allow a WAN computer to manage the Zyxel Device.

You may define additional rules and sets or modify existing ones but please exercise extreme caution in doing so.

For example, you may create rules to:

- Block certain types of traffic, such as IRC (Internet Relay Chat), from the LAN to the Internet.
- Allow certain types of traffic, such as Lotus Notes database synchronization, from specific hosts on the Internet to specific hosts on the LAN.
- Allow everyone except your competitors to access a web server.
- Restrict use of certain protocols, such as Telnet, to authorized users on the LAN.

These custom rules work by comparing the source IP address, destination IP address and IP protocol type of network traffic to rules set by the administrator. Your customized rules take precedence and override the Zyxel Device's default rules.

## 19.7.2 Guidelines For Security Enhancement With Your Firewall

- 1 Change the default password through the Web Configurator.
- 2 Think about access control before you connect to the network in any way.
- 3 Limit who can access your router.
- 4 Don't enable any local service (such as telnet or FTP) that you do not use. Any enabled service could present a potential security risk. A determined hacker might be able to find creative ways to misuse the enabled services to access the firewall or the network.
- 5 For local services that are enabled, protect against misuse. Protect by configuring the services to communicate only with specific peers, and protect by configuring rules to block packets for the services at specific interfaces.

- 6 Protect against IP spoofing by making sure the firewall is active.
- 7 Keep the firewall in a secured (locked) room.

### 19.7.3 Security Considerations

Note: Incorrectly configuring the firewall may block valid access or introduce security risks to the Zyxel Device and your protected network. Use caution when creating or deleting firewall rules and test your rules after you configure them.

Consider these security ramifications before creating a rule:

- 1 Does this rule stop LAN users from accessing critical resources on the Internet? For example, if IRC (Internet Relay Chat) is blocked, are there users that require this service?
- 2 Is it possible to modify the rule to be more specific? For example, if IRC is blocked for all users, will a rule that blocks just certain users be more effective?
- 3 Does a rule that allows Internet users access to resources on the LAN create a security vulnerability? For example, if FTP ports (TCP 20, 21) are allowed from the Internet to the LAN, Internet users may be able to connect to computers with running FTP servers.
- 4 Does this rule conflict with any existing rules?

Once these questions have been answered, adding rules is simply a matter of entering the information into the correct fields in the Web Configurator screens.



# CHAPTER 20

## MAC Filter

### 20.1 MAC Filter Overview

You can configure the Zyxel Device to permit access to clients based on their MAC addresses in the **MAC Filter** screen. This applies to wired connections. Every Ethernet device has a unique MAC (Media Access Control) address. The MAC address is assigned at the factory and consists of six pairs of hexadecimal characters, for example, 00:A0:C5:00:00:02. You need to know the MAC addresses of wired LAN client to configure this screen.

### 20.2 MAC Filter

Enable **MAC Address Filter** and add the host name and MAC address of a wired LAN client to the table if you wish to allow or deny them access to your network. You can choose to enable or disable the filters per entry; make sure that the check box under **Active** is selected if you want to use a filter. Select **Security > MAC Filter**. The screen appears as shown.

**Figure 208** Security > MAC Filter

**MAC Filter**

You can configure the Zyxel Device to permit access to clients based on their MAC addresses in the **MAC Filter** screen. This applies to wired connections. Every Ethernet device has a unique MAC (Media Access Control) address. The MAC address is assigned at the factory and consists of six pairs of hexadecimal characters, for example, 00:A0:C5:00:00:02. You need to know the MAC addresses of the LAN client to configure this screen.

Enable **MAC Address Filter** and add the host name and MAC address of a LAN client to the table if you wish to allow or deny them access to your network. You can choose to enable or disable the filters per entry; make sure that the check box under **Active** is selected if you want to use a filter.

MAC Address Filter  Enable  Disable (Settings are invalid when disable)

MAC Restrict Mode  Allow  Deny

Add New Rule

Set	Active	Host Name	MAC Address	Delete
-----	--------	-----------	-------------	--------

The following table describes the labels in this screen.



Table 130 Security &gt; MAC Filter

LABEL	DESCRIPTION
MAC Address Filter	Select <b>Enable</b> to activate the MAC filter function.
MAC Restrict Mode	Select <b>Allow</b> to only permit the listed MAC addresses access to the Zyxel Device. Select <b>Deny</b> to permit anyone access to the Zyxel Device except the listed MAC addresses.
Add New Rule	Select an existing wired LAN client from the list to add as a new entry. Select <b>Custom</b> if you want to manually enter the <b>Host Name</b> and <b>MAC Address</b> .  Click the <b>Add</b> button to create a new entry.
Set	This is the index number of the MAC address.
Active	Select <b>Active</b> to enable the MAC filter rule. The rule will not be applied if <b>Allow</b> is not selected under <b>MAC Restrict Mode</b> .
Host Name	Enter the host name of a wired LAN client that you want to allow access to the Zyxel Device. You can use up to 17 printable characters except [ " ], [ ` ], [ ' ], [ < ], [ > ], [ ^ ], [ \$ ], [   ], [ & ], or [ ; ]. Spaces are allowed.
MAC Address	Enter the MAC address of a wired LAN client that you want to allow access to the Zyxel Device. Enter the MAC addresses in a valid MAC address format, that is, six hexadecimal character pairs, for example, 12:34:56:78:9a:bc.
Delete	Click the <b>Delete</b> icon to delete an existing rule.
Cancel	Click <b>Cancel</b> to restore your previously saved settings.
Apply	Click <b>Apply</b> to save your changes.

## 20.2.1 Add New Rule

You can choose to enable or disable the filters per entry; make sure that the check box under **Active** is selected if you want to use a filter, as shown in the example below. Select **Security > MAC Filter > Add New Rule**. The screen appears as shown.

Figure 209 Security &gt; MAC Filter &gt; Add New Rule

Set	Active	Host Name	MAC Address	Delete
1	<input checked="" type="checkbox"/>	test	BC - 22 - 33 - 11 - 66 - AA	
2	<input checked="" type="checkbox"/>	Test	BC - 88 - 99 - 00 - 11 - 22	

The following table describes the labels in this screen.

Table 131 Security &gt; MAC Filter &gt; Add New Rule

LABEL	DESCRIPTION
Set	This is the index number of the MAC address.
Active	Select <b>Active</b> to enable the MAC filter rule. The rule will not be applied if <b>Allow</b> is not selected under <b>MAC Restrict Mode</b> .
Host Name	Enter the host name of a wired LAN client that you want to allow access to the Zyxel Device. You can use up to 17 printable characters except [ " ], [ ` ], [ ' ], [ < ], [ > ], [ ^ ], [ \$ ], [   ], [ & ], or [ ; ]. Spaces are allowed.
MAC Address	Enter the MAC addresses of a wired LAN client that you want to allow access to the Zyxel Device in these address fields. Enter the MAC addresses in a valid MAC address format, that is, six hexadecimal character pairs, for example, 12:34:56:78:9a:bc.

Table 131 Security &gt; MAC Filter &gt; Add New Rule (continued)

LABEL	DESCRIPTION
Delete	Click the <b>Delete</b> icon to delete an existing rule.
Cancel	Click <b>Cancel</b> to restore your previously saved settings.
Apply	Click <b>Apply</b> to save your changes.

# Chapter 21

## Home Security

### 21.1 Home Security Overview

The Zyxel Device supports URL (Uniform Resource Locator) filtering that allows you to block user access to specific websites containing inappropriate or harmful content. Users on your network will not be able to enter the websites with URL domain names, keywords or full URLs you specify. Check [Section 1.1 on page 19](#) to see if your Zyxel Device supports the Home Security feature.

### 21.2 Home Security

Use this screen to configure URL filtering settings to block users on your network from accessing certain websites. To access this screen, click **Security > Home Security**.

**Figure 210** Security > Home Security

**Connected Home Security**

You may be more specific by adding URL into the list. The website under the specific domain will be blocked.

Enter Website URL

example.com **Block**

Block List

examplewebsite X

The following table describes the labels in this screen.

Table 132 Security &gt; Home Security

LABEL	DESCRIPTION
Enter Website URL	<p>Enter the URL of a website or URL keyword to which the Zyxel Device blocks access. Click <b>Block</b> to add the website to the <b>Block List</b>.</p> <p>Use keywords, domain names, or full URLs to block websites. For example, if you want to block a website with the domain name "www.exampleWeb.com", you can use the following input formats:</p> <ul style="list-style-type: none"><li>• http://exampleWeb.com</li><li>• https://exampleWeb.com</li><li>• exampleWeb.com</li><li>• www.exampleWeb.com</li><li>• example</li></ul>
Block List	The Zyxel Device prohibits users on your network from viewing the websites with the URLs/keywords in this block list. Click <b>x</b> to remove the entry from the list.

# CHAPTER 22

## Parental Control

### 22.1 Parental Control Overview

Parental control allows you to limit the time a user can access the Internet and prevent users from viewing inappropriate content or participating in specified online activities.

Your parental control screens may be different depending on the model you're using. Some Zyxel Devices support scheduling, some support scheduling and URL filtering.

See [Section 1.1 on page 19](#) for more information.

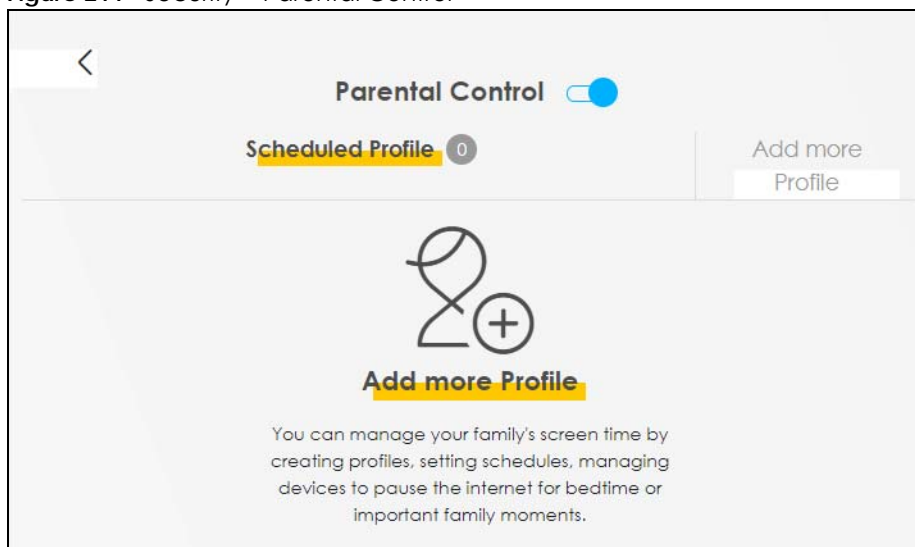
### 22.2 Parental Control Schedule

Use this screen to enable parental control and view parental control rules and schedules. You can limit the time a user can access the Internet. These rules are defined in a Parental Control Profile (PCP).

Click **Security > Parental Control** to open the following screen.

Note: For some Zyxel Device models, you need to disable MESH to add a new parental control profile.

**Figure 211** Security > Parental Control



The following table describes the fields in this screen.

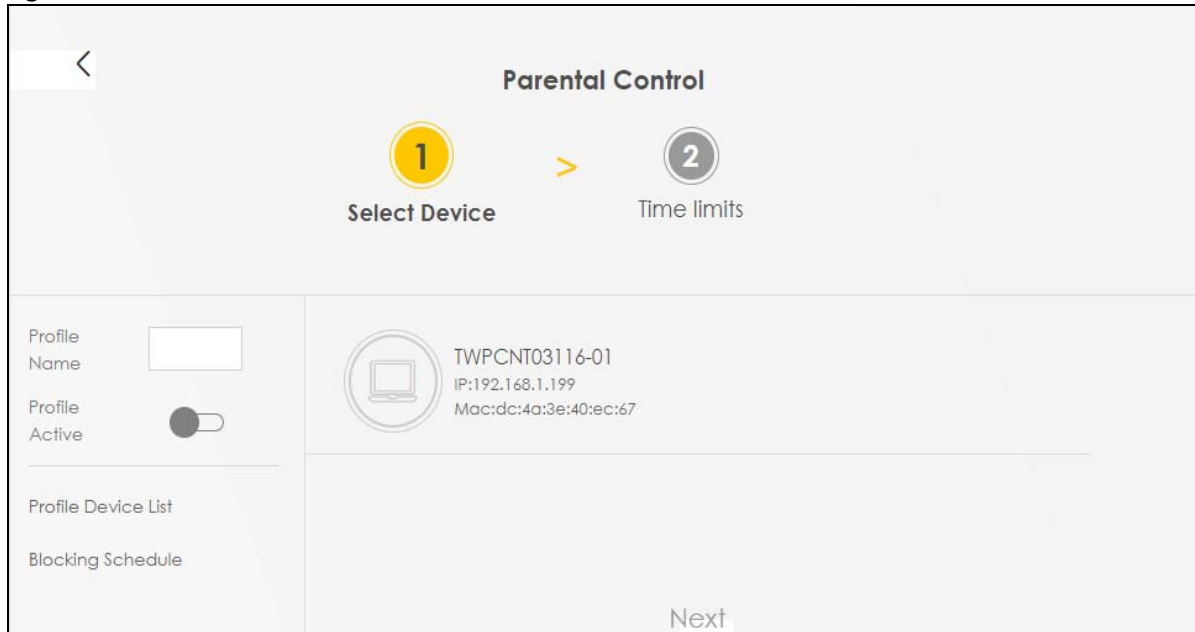
Table 133 Security &gt; Parental Control

LABEL	DESCRIPTION
Parental Control	Click this switch to enable or disable parental control.
Scheduled Profile	This screen shows all the created profiles.
Add more Profile	Click this button to create a new profile.

## 22.2.1 Add or Edit a Parental Control Profile

Click **Add more Profile** in the **Parental Control** screen to add a new rule or click the **Edit** icon next to an existing rule to edit it. Use this screen to configure a restricted access schedule.

Figure 212 Parental Control &gt; Add more Profile: Select Device



The following table describes the fields in this screen.

Table 134 Parental Control &gt; Add more Profile: Select Device

LABEL	DESCRIPTION
Profile Name	Enter a descriptive name for the profile. You can use up to 17 printable characters except [ " ], [ ` ], [ ' ], [ < ], [ > ], [ ^ ], [ \$ ], [   ], [ & ], or [ : ]. Spaces are allowed.
Profile Active	Click this switch to enable or disable this profile.
Profile Device List	This field shows the devices selected on the right for this profile.
Blocking Schedule	This field shows the time during which Internet access is blocked on the profile devices.
Next	Click <b>Next</b> to go to the next step to set a schedule for this profile.


## 22.2.2 Define a Schedule

This screen allow you to define time periods and days during which Internet access is blocked on the profile devices. Finish the settings in the **Select Device** step and click **Next** to access this screen.

**Figure 213** Parental Control > Add more Profile: Time limits

The following table describes the fields in this screen.

**Table 135** Parental Control > Add more Profile: Time limits

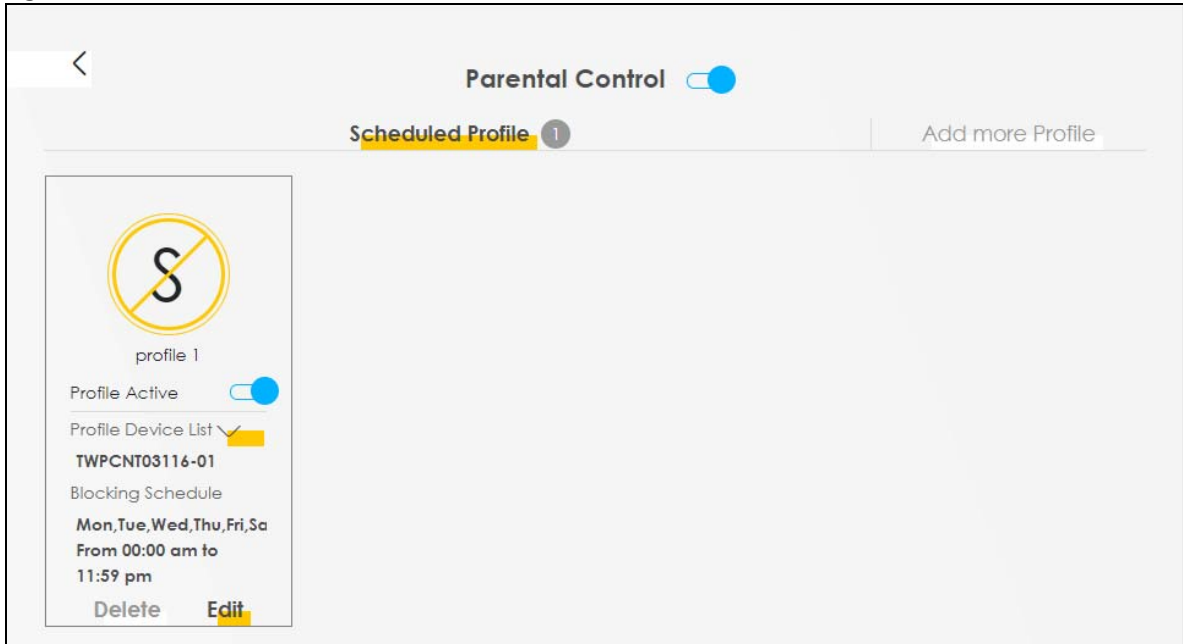
LABEL	DESCRIPTION
Profile Name	Enter a descriptive name for the profile.
Profile Active	Click this switch to enable or disable this profile. When the switch goes to the right (  , this profile is active. Otherwise, it is not.
Profile Device List	This field shows the devices selected on the right for this profile.
Blocking Schedule	This field shows the time during which Internet access is blocked on the profile devices.
Schedule	
Add New Schedule	Click this to add a new block for scheduling.
Start/End blocking	Select the time period when Internet access is blocked on the profile devices.
Repeat On	Select the days when Internet access is blocked on the profile devices. Select <b>Whole Week</b> and the scheduler rule will be activated for the whole week.
Back	Click <b>Back</b> to return to the previous screen.
Save	Click <b>Save</b> to save your changes.

## 22.2.3 Parental Control Scheduled Profile

Use this screen to view and manage the created parental control profiles.






Figure 214 Parental Control &gt; Scheduled Profile



The following table describes the fields in this screen.

Table 136 Parental Control &gt; Scheduled Profile

LABEL	DESCRIPTION
Parental Control	Click this switch to enable or disable parental control. When the switch goes to the right (  ), the function is enabled. Otherwise, it is not.
Profile Active	Click this switch to enable or disable a created profile. When the switch goes to the right (  ), this profile is active. Otherwise, it is not.
Scheduled Profile	This screen shows all the created profiles. Click  beside <b>Profile Device List</b> to view more information about the profile. You can click <b>Delete</b> to remove the profile or click <b>Edit</b> to change the profile settings. Only the <b>Add more Profile</b> button displays if there is no profile created.
Add more Profile	Click this button to create a new profile.

## 22.3 Parental Control Schedule and URL Filter

Use this screen to enable parental control and view parental control rules and schedules. You can limit the time a user can access the Internet and prevent users from viewing inappropriate content or participating in specified online activities. These rules are defined in a Parental Control Profile (PCP).

Click **Security > Parental Control** to open the following screen.

Figure 215 Security &gt; Parental Control

**Parental Control**

Parental control allows you to limit the time a user can access the Internet and prevent users from viewing inappropriate content or participating in specified online activities.

Use this screen to enable parental control and view parental control rules and schedules. You can limit the time a user can access the Internet and prevent users from viewing inappropriate content or participating in specified online activities. These rules are defined in a Parental Control Profile (PCP).

**General**

Parental Control  Enable  Disable (Settings are invalid when disable)

**Parental Control Profile (PCP)** + Add New PCP

#	Status	PCP Name	Home Network User MAC	Internet Access Schedule	Network Service	Website Blocked	Modify
<span>Cancel</span> <span>Apply</span>							

The following table describes the fields in this screen.

Table 137 Security &gt; Parental Control

LABEL	DESCRIPTION
General	
Parental Control	Select <b>Enable</b> to activate parental control on the Zyxel Device.
Parental Control Profile (PCP)	
Add new PCP	Click this if you want to configure a new Parental Control Profile (PCP).
#	This shows the index number of the rule.
Status	This indicates whether the rule is active or not. A yellow bulb signifies that this rule is active. A gray bulb signifies that this rule is not active
PCP Name	This shows the name of the rule.
Home Network User MAC	This shows the MAC address of the LAN user's computer to which this rule applies.
Internet Access Schedule	This shows the days and time on which parental control is enabled.
Network Service	This shows whether the network service is configured. If not, <b>None</b> will be shown.
Website Blocked	This shows whether the website block is configured. If not, <b>None</b> will be shown.
Modify	Click the <b>Edit</b> icon to go to the screen where you can edit the rule. Click the <b>Delete</b> icon to delete an existing rule.
Cancel	Click <b>Cancel</b> to restore your previously saved settings.
Apply	Click <b>Apply</b> to save your changes.

## 22.3.1 Add or Edit a Parental Control Profile

Click **Add new PCP** in the **Parental Control** screen to add a new rule or click the **Edit** icon next to an existing rule to edit it. Use this screen to configure a restricted access schedule and/or URL filtering settings to block the users on your network from accessing certain web sites.

**Figure 216** Security > Parental Control > Add or Edit PCP (General, Rule List & Internet Access Schedule)

The screenshot displays the 'Add New PCP' configuration interface, which is divided into three main sections: General, Rule List, and Internet Access Schedule.

- General:** This section contains the 'Active' status, which is currently set to 'Enable' (indicated by a selected radio button). Below this are input fields for 'Parental Control Profile Name' and 'Home Network User'. The 'Home Network User' field is set to 'Custom' and includes a dropdown arrow and an 'Add' button. A date selection field with dashes is also present.
- Rule List:** This section features a table with two columns: 'User MAC Address' and 'Delete'. The table is currently empty.
- Internet Access Schedule:** This section allows for configuring the days and times for internet access. It includes a 'Day' row with seven circular buttons for 'Mon', 'Tue', 'Wed', 'Thu', 'Fri', 'Sat', and 'Sun'. Below the days is an 'Add New Time' button with a plus sign. The 'Time (Start-End)' row shows a horizontal timeline with a start time of '00:00' and an end time of '24:00'.

**Figure 217** Security > Parental Control > Add or Edit PCP (Network Service & Site/URL Keyword)

The screenshot shows the configuration interface for Parental Control Profiles (PCP). It is split into two main sections: 'Network Service' and 'Site/URL Keyword'.  
 In the 'Network Service' section, there is a dropdown menu labeled 'Network Service Setting' currently set to 'Block'. To its right is a text field for 'Selected Service(s)' and a yellow plus icon labeled 'Add New Service'. Below this is a table with four columns: '#', 'Service Name', 'Protocol:Port', and 'Modify'.  
 In the 'Site/URL Keyword' section, there is a dropdown menu labeled 'Block or Allow the Web Site' currently set to 'Block the web URLs'. To its right is a yellow plus icon labeled 'Add'. Below this is a table with three columns: '#', 'Website', and 'Modify'.  
 At the bottom of the screen are two buttons: 'Cancel' and 'OK'.

The following table describes the fields in this screen.

**Table 138** Security > Parental Control > Add or Edit PCP

LABEL	DESCRIPTION
General	
Active	Select <b>Enable</b> or <b>Disable</b> to activate or deactivate the parental control rule.
Parental Control Profile Name	Enter a descriptive name for the profile. You can use up to 17 printable characters except [ " ], [ ` ], [ ' ], [ < ], [ > ], [ ^ ], [ \$ ], [   ], [ & ], or [ ; ]. Spaces are allowed.
Home Network User	Select the LAN user that you want to apply this rule to from the drop-down list box. If you select <b>Custom</b> , enter the LAN user's MAC address. If you select <b>All</b> , the rule applies to all LAN users.
Rule List	In <b>Home Network User</b> , select <b>Custom</b> , enter the LAN user's MAC address, then click the <b>Add</b> icon to enter a computer MAC address for this PCP. Up to five are allowed. Click the <b>Delete</b> icon to remove one.
Internet Access Schedule	
Day	Select check boxes for the days that you want the Zyxel Device to perform parental control.
Time (Start-End)	Drag the time bar to define the time that the LAN user is allowed access ( <b>Authorized access</b> ) or denied access ( <b>No access</b> ).
Add New Time	Click this to add a new time bar. Up to three are allowed.
Network Service	
Network Service Setting	If you select <b>Block</b> , the Zyxel Device prohibits the users from viewing the web sites with the URLs listed below. If you select <b>Allow</b> , the Zyxel Device blocks access to all URLs except ones listed below.
Add New Service	Click this to show a screen in which you can add a new service rule. You can configure the <b>Service Name</b> , <b>Protocol</b> , and <b>Port</b> of the new rule, as shown in <a href="#">Figure 218</a> .
#	This shows the index number of the rule.
Service Name	This shows the name of the rule.
Protocol:Port	This shows the protocol and the port of the rule.

**Table 138** Security > Parental Control > Add or Edit PCP (continued)

LABEL	DESCRIPTION
Modify	Click the <b>Edit</b> icon to go to the screen where you can edit the rule. Click the <b>Delete</b> icon to delete an existing rule.
Site/URL Keyword	
Block or Allow the Web Site	If you select <b>Block the Web URLs</b> , the Zyxel Device prohibits the users from viewing the Web sites with the URLs listed below.  If you select <b>Allow the Web URLs</b> , the Zyxel Device blocks access to all URLs except ones listed below.
Add	Click <b>Add</b> to show a screen to enter the URL of web site or URL keyword to which the Zyxel Device blocks or allows access.
#	This shows the index number of the rule.
Website	This shows the URL of web site or URL keyword to which the Zyxel Device blocks or allows access.
Modify	Click the <b>Edit</b> icon to go to the screen where you can edit the rule. Click the <b>Delete</b> icon to delete an existing rule.
Cancel	Click <b>Cancel</b> to exit this screen without saving any changes.
OK	Click <b>OK</b> to save your changes.

## Add New Service

Use this screen to add a new service rule.

**Figure 218** Security > Parental Control > Add or Edit PCP > Add New Service

The following table describes the fields in this screen.

**Table 139** Security > Parental Control > Add or Edit PCP > Add New Service

LABEL	DESCRIPTION
Add New Service	Select the name of the service from the drop-down list. Otherwise, select <b>User Define</b> and specify the name, protocol, and port of the service.  If you have chosen a pre-defined service in the <b>Service Name</b> field, this field will not be configurable.
Protocol	Select the transport layer protocol used for the service. Choices are <b>TCP</b> , <b>UDP</b> , or <b>TCP &amp; UDP</b> .
Port	Enter the port of the service.  If you have chosen a pre-defined service in the <b>Service Name</b> field, this field will not be configurable.

Table 139 Security &gt; Parental Control &gt; Add or Edit PCP &gt; Add New Service (continued)

LABEL	DESCRIPTION
Cancel	Click <b>Cancel</b> to exit this screen without saving any changes.
OK	Click <b>OK</b> to save your changes.

## Add Site/URL Keyword

Click **Add** in the **Site/URL Keyword** section of the **Edit** or **Add new PCP** screen to open the following screen.

Note: Do not include "HTTP" or "HTTPS" in the keyword. HTTPS connections cannot be blocked by Parental Control.

Figure 219 Security &gt; Parental Control &gt; Add or Edit PCP &gt; Add Keyword

The following table describes the fields in this screen.

Table 140 Security &gt; Parental Control &gt; Add or Edit PCP &gt; Add Keyword

LABEL	DESCRIPTION
Site/URL Keyword	Enter a keyword and click <b>OK</b> to have the Zyxel Device block access to the website URLs that contain the keyword.
Cancel	Click <b>Cancel</b> to exit this screen without saving any changes.
OK	Click <b>OK</b> to save your changes.

# CHAPTER 23

## Scheduler Rule

### 23.1 Scheduler Rule Overview

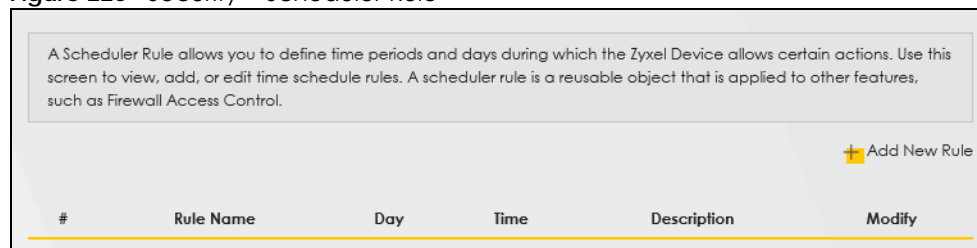
A Scheduler Rule allows you to define time periods and days during which the Zyxel Device allows certain actions.

### 23.2 Scheduler Rule Settings

Use this screen to view, add, or edit time schedule rules. A scheduler rule is a reusable object that is applied to other features, such as Firewall Access Control.

Click **Security > Scheduler Rule** to open the following screen.

**Figure 220** Security > Scheduler Rule



The following table describes the fields in this screen.

Table 141 Security > Scheduler Rule

LABEL	DESCRIPTION
Add New Rule	Click this to create a new rule.
#	This is the index number of the entry.
Rule Name	This shows the name of the rule.
Day	This shows the days on which this rule is enabled.
Time	This shows the period of time on which this rule is enabled.
Description	This shows the description of this rule.
Modify	Click the <b>Edit</b> icon to edit the schedule. Click the <b>Delete</b> icon to delete a scheduler rule.  Note: You cannot delete a scheduler rule once it is applied to a certain feature.

## 23.2.1 Add or Edit a Schedule Rule

Click the **Add New Rule** button in the **Scheduler Rule** screen or click the **Edit** icon next to a schedule rule to open the following screen. Use this screen to configure a restricted access schedule.

**Figure 221** Security > Scheduler Rule: Add or Edit

The following table describes the fields in this screen.

**Table 142** Security > Scheduler Rule: Add or Edit

LABEL	DESCRIPTION
Rule Name	Enter a descriptive name for this schedule. You can use up to 31 printable characters except [ " ], [ ` ], [ ' ], [ < ], [ > ], [ ^ ], [ \$ ], [   ], [ & ], or [ ; ]. Spaces are allowed.
Day	Select check boxes for the days that you want the Zyxel Device to perform this scheduler rule.
Time of Day Range	Enter the time period of each day, in 24-hour format, during which the rule will be enforced.
Description	Enter a description for this scheduler rule. You can use up to 63 printable characters except [ " ], [ ` ], [ ' ], [ < ], [ > ], [ ^ ], [ \$ ], [   ], [ & ], or [ ; ]. Spaces are allowed.
Cancel	Click <b>Cancel</b> to exit this screen without saving.
OK	Click <b>OK</b> to save your changes.



# CHAPTER 24

# Certificates

## 24.1 Certificates Overview

The Zyxel Device can use certificates (also called digital IDs) to authenticate users. Certificates are based on public-private key pairs. A certificate contains the certificate owner's identity and public key. Certificates provide a way to exchange public keys for use in authentication.

### 24.1.1 What You Can Do in this Chapter

- Use the **Local Certificates** screen to view and import the Zyxel Device's CA-signed (Certification Authority) certificates ([Section 24.3 on page 401](#)).
- Use the **Trusted CA** screen to save the certificates of trusted CAs to the Zyxel Device. You can also export the certificates to a computer ([Section 24.4 on page 405](#)).

## 24.2 What You Need to Know

The following terms and concepts may help as you read through this chapter.

### Certification Authority

A Certification Authority (CA) issues certificates and guarantees the identity of each certificate owner. There are commercial certification authorities like CyberTrust or VeriSign and government certification authorities. The certification authority uses its private key to sign certificates. Anyone can then use the certification authority's public key to verify the certificates. You can use the Zyxel Device to generate certification requests that contain identifying information and public keys and then send the certification requests to a certification authority.

## 24.3 Local Certificates

Use this screen to view the Zyxel Device's summary list of certificates, generate certification requests, and import signed certificates. You can import the following certificates to your Zyxel Device:

- Web Server – This certificate secures HTTP connections.
- SSH – This certificate secures remote connections.

Click **Security > Certificates** to open the **Local Certificates** screen.

Figure 222 Security &gt; Certificates &gt; Local Certificates

**Local Certificates** Trusted CA

The Zyxel Device can use certificates (also called digital IDs) to authenticate users. Certificates are based on public-private key pairs. A certificate contains the certificate owner's identity and public key. Certificates provide a way to exchange public keys for use in authentication.

Use this screen to view the Zyxel Device's summary list of certificates, generate certification requests, and import signed certificates.

Replace PrivateKey/Certificate file in PEM format

Private Key is protected by password

Browse...

Current File	Subject	Issuer	Valid From	Valid To	Modify
--------------	---------	--------	------------	----------	--------

The following table describes the labels in this screen.

Table 143 Security &gt; Certificates &gt; Local Certificates

LABEL	DESCRIPTION
Replace Private Key/Certificate file in PEM format	
Private Key is protected by password	Select the check box and enter the private key into the text box to store it on the Zyxel Device. You can use up to 63 alphanumeric (0-9, a-z, A-Z) and special characters, including spaces.
Choose File/Browse	Click this button to find the certificate file you want to upload.
Import Certificate	Click this button to save the certificate that you have enrolled from a certification authority from your computer to the Zyxel Device.
Create Certificate Request	Click this button to go to the screen where you can have the Zyxel Device generate a certification request.
Current File	This field displays the name used to identify this certificate. It is recommended that you give each certificate a unique name.
Subject	This field displays identifying information about the certificate's owner, such as <b>CN</b> (Common Name), <b>OU</b> (Organizational Unit or department), <b>O</b> (Organization or company) and <b>C</b> (Country). It is recommended that each certificate have a unique subject information.
Issuer	This field displays identifying information about the certificate's issuing certification authority, such as a common name, organizational unit or department, organization or company and country.
Valid From	This field displays the date that the certificate becomes applicable. The text displays in red and includes a <b>Not Yet Valid!</b> message if the certificate has not yet become applicable.
Valid To	This field displays the date that the certificate expires. The text displays in red and includes an <b>Expiring!</b> or <b>Expired!</b> message if the certificate is about to expire or has already expired.
Modify	Click the <b>View</b> icon to open a screen with an in-depth list of information about the certificate.  For a certification request, click <b>Load Signed</b> to import the signed certificate.  Click the <b>Remove</b> icon to remove the certificate (or certification request). A window displays asking you to confirm that you want to delete the certificate. Note that subsequent certificates move up by one when you take this action.

## 24.3.1 Create Certificate Request

Click **Security > Certificates > Local Certificates** and then **Create Certificate Request** to open the following screen. Use this screen to have the Zyxel Device generate a certification request. To create a certificate signing request, you need to enter a common name, organization name, state or province name, and the default US two-letter country code (The US country code is by default and not changeable when sold in the U.S.) for the certificate.

**Figure 223** Security > Certificates > Local Certificates: Create Certificate Request

The following table describes the labels in this screen.

**Table 144** Security > Certificates > Local Certificates: Create Certificate Request

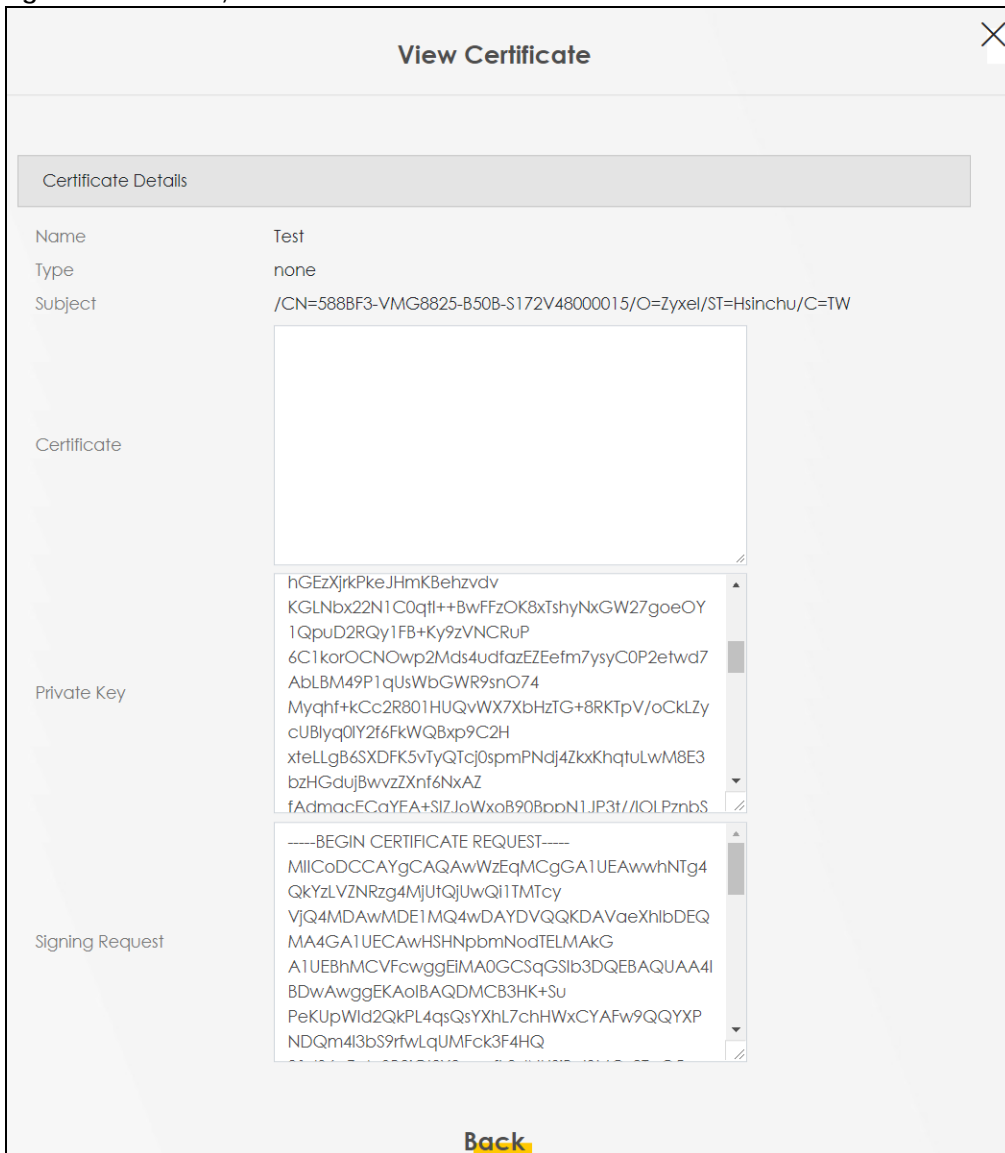
LABEL	DESCRIPTION
Certificate Name	Enter a descriptive name to identify this certificate. You can use up to 63 printable characters except [ " ], [ ` ], [ ' ], [ < ], [ > ], [ ^ ], [ \$ ], [   ], [ & ], or [ ; ]. Spaces are allowed.
Common Name	Select <b>Auto</b> to have the Zyxel Device configure this field automatically. Or select <b>Customize</b> to enter it manually.  Enter the IP address (in dotted decimal notation), domain name or email address in the field provided. You can use up to 63 printable characters except [ " ], [ ` ], [ ' ], [ < ], [ > ], [ ^ ], [ \$ ], [   ], [ & ], or [ ; ]. Spaces are allowed. The domain name or email address is for identification purposes only and can be any string.
Organization Name	Enter a descriptive name to identify the company or group to which the certificate owner belongs. You can use up to 32 printable characters except [ " ], [ ` ], [ ' ], [ < ], [ > ], [ ^ ], [ \$ ], [   ], [ & ], or [ ; ]. Spaces are allowed.
State/Province Name	Enter a descriptive name to identify the state or province where the certificate owner is located. You can use up to 32 printable characters except [ " ], [ ` ], [ ' ], [ < ], [ > ], [ ^ ], [ \$ ], [   ], [ & ], or [ ; ]. Spaces are allowed.
Country/Region Name	Select a country to identify the nation where the certificate owner is located.
Cancel	Click <b>Cancel</b> to exit this screen without saving.
OK	Click <b>OK</b> to save your changes.

## 24.3.2 View Certificate Request

Use this screen to view in-depth information about the certificate request. The **Certificate** is used to verify the authenticity of the certification authority. The **Private Key** serves as your digital signature for authentication and must be safely stored. The **Signing Request** contains the certificate signing request value that you will copy upon submitting the certificate request to the CA (certificate authority).

Click the **View** icon in the **Local Certificates** screen to open the following screen.

**Figure 224** Security > Certificates > Local Certificates: View Certificate



The following table describes the fields in this screen.

Table 145 Security > Certificates > Local Certificates: View Certificates

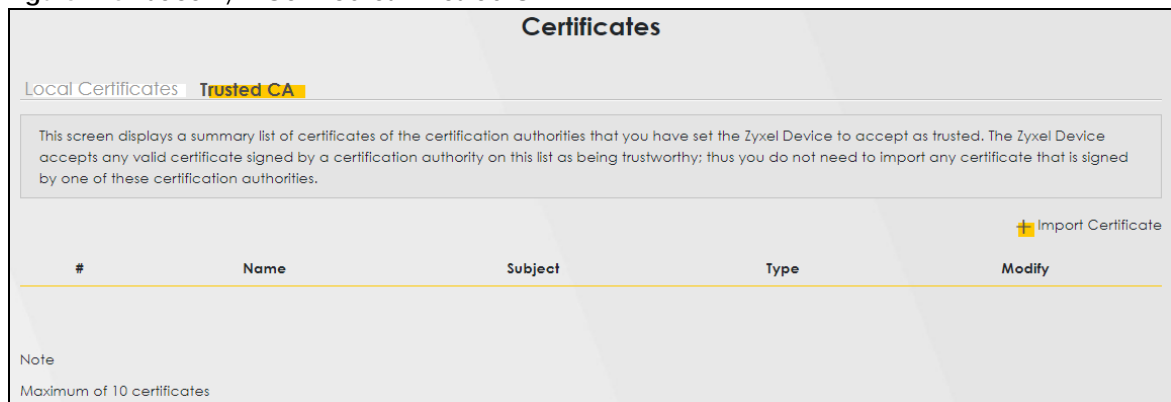
LABEL	DESCRIPTION
Name	This field displays the identifying name of this certificate.
Type	This field displays general information about the certificate. <b>ca</b> means that a Certification Authority signed the certificate.
Subject	This field displays information that identifies the owner of the certificate, such as Common Name (CN), Organizational Unit (OU), Organization (O) and Country (C).
Certificate	This read-only text box displays the certificate in Privacy Enhanced Mail (PEM) format. PEM uses base 64 to convert the binary certificate into a printable form.  You can copy and paste the certificate into an email to send to friends or colleagues or you can copy and paste the certificate into a text editor and save the file on a management computer for later distribution.
Private Key	This field displays the private key of this certificate.
Signing Request	This field displays the CSR (Certificate Signing Request) information of this certificate. The CSR will be provided to a certificate authority, and it includes information about the public key, organization name, domain name, location, and country of this certificate.
Back	Click <b>Back</b> to return to the previous screen.

## 24.4 Trusted CA

Click **Security > Certificates > Trusted CA** to open the following screen. This screen displays a summary list of certificates of the certification authorities that you have set the Zyxel Device to accept as trusted. The Zyxel Device accepts any valid certificate signed by a certification authority on this list as being trustworthy, which means you do not need to import any certificate that is signed by one of these certification authorities.

Note: A maximum of ten certificates can be added.

Figure 225 Security > Certificates > Trusted CA



The following table describes the labels in this screen.

Table 146 Security > Certificates > Trusted CA

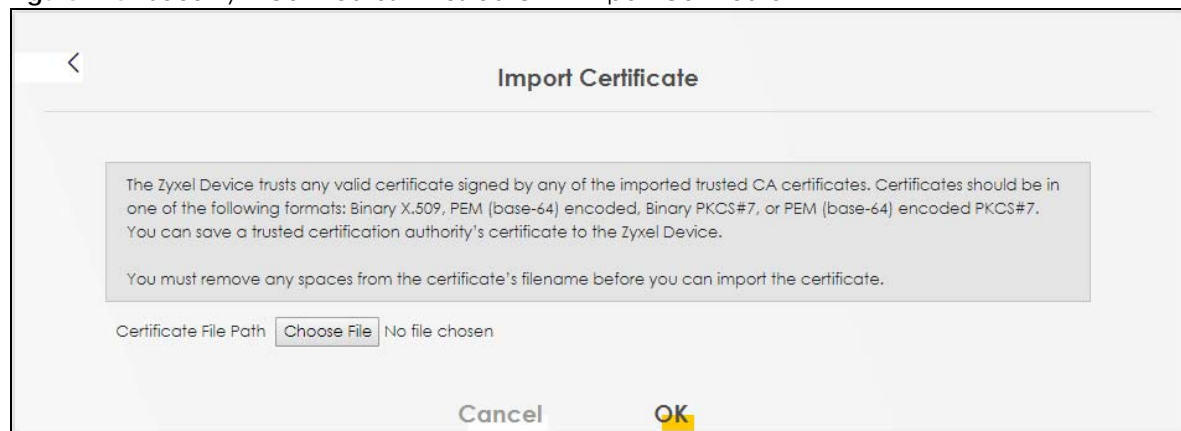
LABEL	DESCRIPTION
Import Certificate	Click this to open a screen where you can save the certificate of a certification authority that you trust to the Zyxel Device.
#	This is the index number of the entry.
Name	This field displays the name used to identify this certificate.
Subject	This field displays information that identifies the owner of the certificate, such as Common Name (CN), OU (Organizational Unit or department), Organization (O), State (ST) and Country (C). It is recommended that each certificate have a unique subject information.
Type	This field displays general information about the certificate. <b>ca</b> means that a Certification Authority signed the certificate.
Modify	Click the <b>View</b> icon to open a screen with an in-depth list of information about the certificate (or certification request).  Click the <b>Remove</b> icon to delete the certificate (or certification request). You cannot delete a certificate that one or more features is configured to use.

## 24.5 Import Trusted CA Certificate

Click **Import Certificate** in the **Trusted CA** screen to open the **Import Certificate** screen. The Zyxel Device trusts any valid certificate signed by any of the imported trusted CA certificates. Certificates should be in one of the following formats: Binary X.509, PEM (base-64) encoded, Binary PKCS#7, or PEM (base-64) encoded PKCS#7.

Note: You must remove any spaces from the certificate's filename before you can import the certificate.

Figure 226 Security > Certificates > Trusted CA > Import Certificate



The following table describes the labels in this screen.

Table 147 Security > Certificates > Trusted CA > Import Certificate

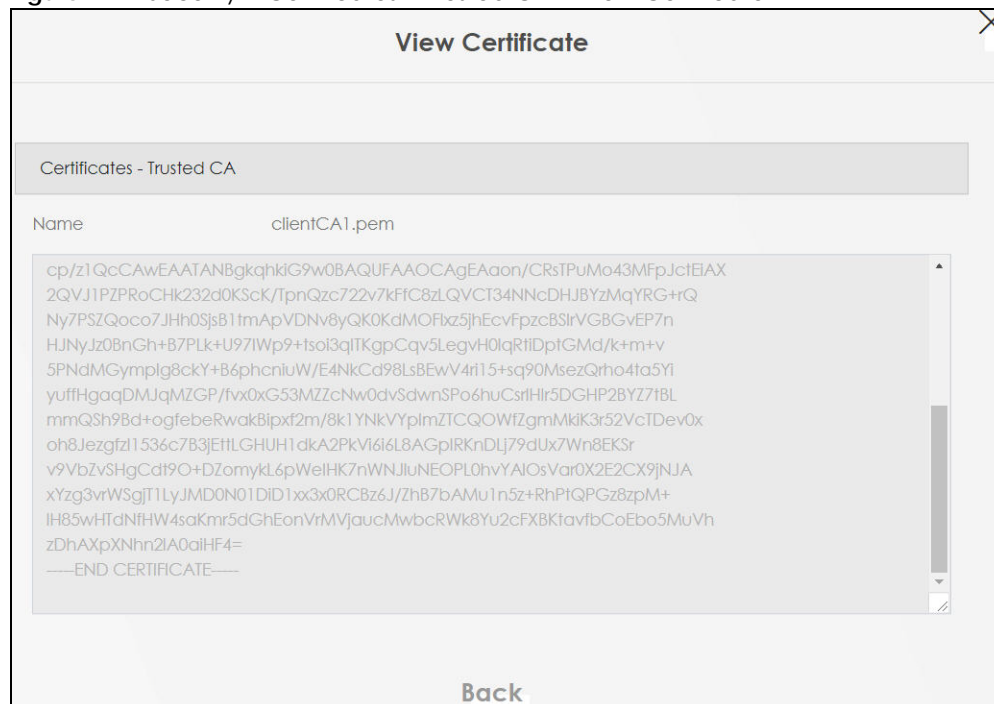
LABEL	DESCRIPTION
Certificate File Path	Enter the location of the file you want to upload in this field or click <b>Choose File/Browse</b> to find it.
Choose File/Browse	Click this to find the certificate file you want to upload.
OK	Click this to save the certificate on the Zyxel Device.
Cancel	Click this to exit this screen without saving.

## 24.6 View Trusted CA Certificate

Use this screen to view in-depth information about the certification authority's certificate. The certificate text box is read-only and can be distributed to others.

Click **Security > Certificates > Trusted CA** to open the **Trusted CA** screen. Click the **View** icon to open the **View Certificate** screen.

Figure 227 Security > Certificates > Trusted CA > View Certificate



The following table describes the labels in this screen.

Table 148 Security > Certificates > Trusted CA > View Certificate

LABEL	DESCRIPTION
Name	This field displays the identifying name of this certificate.
	<p>This read-only text box displays the certificate or certification request in Privacy Enhanced Mail (PEM) format. PEM uses 64 ASCII characters to convert the binary certificate into a printable form.</p> <p>You can copy and paste the certificate into an email to send to friends or colleagues or you can copy and paste the certificate into a text editor and save the file on a management computer for later distribution (through USB thumb drive for example).</p>
Back	Click this to return to the previous screen.

## 24.7 Certificates Technical Reference

This section provides some technical background information about the topics covered in this chapter.

### Certification Authorities

A Certification Authority (CA) issues certificates and guarantees the identity of each certificate owner. There are commercial certification authorities like CyberTrust or VeriSign and government certification authorities.

### Public and Private Keys

When using public-key cryptology for authentication, each host has two keys. One key is public and can be made openly available; the other key is private and must be kept secure. Public-key encryption in general works as follows.

- 1 Tim wants to send a private message to Jenny. Tim generates a public-private key pair. What is encrypted with one key can only be decrypted using the other.
- 2 Tim keeps the private key and makes the public key openly available.
- 3 Tim uses his private key to encrypt the message and sends it to Jenny.
- 4 Jenny receives the message and uses Tim's public key to decrypt it.
- 5 Additionally, Jenny uses her own private key to encrypt a message and Tim uses Jenny's public key to decrypt the message.

The Zyxel Device uses certificates based on public-key cryptology to authenticate users attempting to establish a connection. The method used to secure the data that you send through an established connection depends on the type of connection. For example, a VPN tunnel might use the triple DES encryption algorithm.

The certification authority uses its private key to sign certificates. Anyone can then use the certification authority's public key to verify the certificates.



## Advantages of Certificates

Certificates offer the following benefits.

- The Zyxel Device only has to store the certificates of the certification authorities that you decide to trust, no matter how many devices you need to authenticate.
- Key distribution is simple and very secure since you can freely distribute public keys and you never need to transmit private keys.

## Certificate File Format

The certification authority certificate that you want to import has to be in PEM (Base-64) encoded X.509 file format. This Privacy Enhanced Mail format uses 64 ASCII characters to convert a binary X.509 certificate into a printable form.

### 24.7.1 Verify a Certificate

Before you import a trusted CA or trusted remote host certificate into the Zyxel Device, you should verify that you have the actual certificate. This is especially true of trusted CA certificates since the Zyxel Device also trusts any valid certificate signed by any of the imported trusted CA certificates.

You can use a certificate's fingerprint to verify it. A certificate's fingerprint is a message digest calculated using the MD5 or SHA1 algorithms. The following procedure describes how to check a certificate's fingerprint to verify that you have the actual certificate.

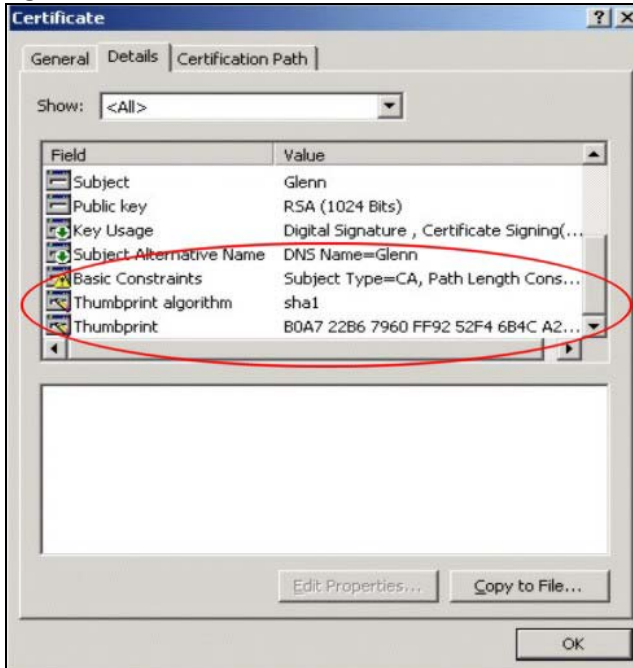
- 1 Browse to where you have the certificate saved on your computer.
- 2 Make sure that the certificate has a ".cer" or ".crt" file name extension.

**Figure 228** Certificates on Your Computer



- 3 Double-click the certificate's icon to open the **Certificate** window. Click the **Details** tab and scroll down to the **Thumbprint Algorithm** and **Thumbprint** fields.

Figure 229 Certificate Details



Use a secure method to verify that the certificate owner has the same information in the **Thumbprint Algorithm** and **Thumbprint** fields. The secure method may vary based on your situation. Possible examples would be over the telephone or through an HTTPS connection.

# CHAPTER 25

## Voice

### 25.1 Voice Overview

You can make calls over the Internet using VoIP technology. For this, you first need to set up a SIP account with a SIP service provider.

Use this chapter to:

- Connect an analog phone to the Zyxel Device.
- Configure settings such as speed dial.
- Configure network settings to optimize the voice quality of your phone calls.

#### 25.1.1 What You Can Do in this Chapter

These screens allow you to configure your Zyxel Device to make phone calls over the Internet and your regular phone line, and to set up the phone you connect to the Zyxel Device.

- Use the **SIP Account** screen to set up information about your SIP account, control which SIP accounts the phones connected to the Zyxel Device use, and configure audio settings such as volume levels for the phones connected to the Zyxel Device ([Section 25.3 on page 412](#)).
- Use the **SIP Service Provider** screen to configure the SIP server information, and the numbers for certain phone functions ([Section 25.4 on page 418](#)).
- Use the **SIP TLS Common** screen to change the default TLS local port if you need to, and select a local certificate for the SIP server to verify the Zyxel Device. ([Section 25.5 on page 423](#)).
- Use the **Phone** screens to change settings that depend on which region of the world the Zyxel Device is in ([Section 25.6 on page 424](#)).
- Use the **Call Rule** screen to set up shortcuts for dialing frequently-used (VoIP) phone numbers ([Section 25.8 on page 427](#)).
- Use the **Call History** screen to view a call history list ([Section 25.9 on page 428](#)).

You do not necessarily need to use all these screens to set up your account. In fact, if your service provider did not supply information on a particular field in a screen, it is usually best to leave it at its default setting.

#### 25.1.2 What You Need to Know About VoIP

##### VoIP

VoIP stands for Voice over IP. IP is the Internet Protocol, which is the message-carrying standard the Internet runs on. So, Voice over IP is the sending of voice signals (speech) over the Internet (or another network that uses the Internet Protocol).

## SIP

SIP stands for Session Initiation Protocol. SIP is a signaling standard that lets one network device (like a computer or the Zyxel Device) send messages to another. In VoIP, these messages are about phone calls over the network. For example, when you dial a number on your Zyxel Device, it sends a SIP message over the network asking the other device (the number you dialed) to take part in the call. To access this screen, click **VoIP > SIP**.

## SIP Accounts

A SIP account is a type of VoIP account. It is an arrangement with a service provider that lets you make phone calls over the Internet. When you set the Zyxel Device to use your SIP account to make calls, the Zyxel Device is able to send all the information about the phone call to your service provider on the Internet.

Strictly speaking, you do not need a SIP account. It is possible for one SIP device (like the Zyxel Device) to call another without involving a SIP service provider. However, the networking difficulties involved in doing this make it tremendously impractical under normal circumstances. Your SIP account provider removes these difficulties by taking care of the call routing and setup – figuring out how to get your call to the right place in a way that you and the other person can talk to one another.

## SIP Address

A SIP address is a URI (Uniform Resource Identifier) that resembles an email address, using the format: user@domain. It uniquely identifies a telephone extension over a VoIP system. A SIP address of 123-45-67@voip-provider.net tells a client to connect to voip-provider.net and request a connection to 123-45-67. While VoIP can only send voice messages over the Internet, SIP (though strictly speaking is a type of VoIP) can send voice, data, video, and other media. VoIP phones also need to be connected to a computer to function, whereas SIP phones only need to be connected to a modem.

## 25.2 Before You Begin

- Before you can use these screens, you need to have a VoIP account already set up. If you do not have one yet, you can sign up with a VoIP service provider over the Internet.
- You should have the information your VoIP service provider gave you ready, before you start to configure the Zyxel Device.

## 25.3 SIP Account

You can make calls over the Internet using VoIP technology. For this, you first need to set up a SIP account with a SIP service provider. The Zyxel Device uses a SIP account to make outgoing VoIP calls, and to check if an incoming call's destination number matches your SIP account's VoIP number. In order to make and receive VoIP calls, you need to enable and configure a SIP account, and then map it to a phone port. The SIP account contains information that allows your Zyxel Device to connect to your VoIP service provider.

To access this screen, click **VoIP > SIP > SIP Account**.

Figure 230 VoIP &gt; SIP &gt; SIP Account

**SIP Account** | SIP Service Provider

You can make calls over the Internet using VoIP technology. For this, you first need to set up a SIP account with a SIP service provider.

The Zyxel Device uses a SIP account to make outgoing VoIP calls and check if an incoming call's destination number matches your SIP account's VoIP number. In order to make or receive a VoIP call, you need to enable and configure a SIP account and map it to a phone port. The SIP account contains information that allows your Zyxel Device to connect to your VoIP service provider.

[+ Add New Account](#)

#	Enable	SIP Account	Service Provider	Account Number	Modify
1	Enabled	SIP1	Verizon	Account1	
2	Enabled	SIP2	Verizon	Account2	
3	Disabled	SIP3	Verizon	Account3	

The following table describes the labels in this screen.

Table 149 VoIP &gt; SIP &gt; SIP Account

LABEL	DESCRIPTION
Add New Account	Click this to configure a SIP account.
#	This is the index number of the entry.
Enable	This shows whether the SIP account is activated or not. A yellow bulb signifies that this SIP account is activated. A gray bulb signifies that this SIP account is activated.
SIP Account	This shows the name of the SIP account.
Service Provider	This shows the name of the SIP service provider.
Account Number	This shows the SIP number.
Modify	Click the <b>Modify</b> icon to configure the SIP account.

### 25.3.1 Add or Edit SIP Account

Use this screen to configure a SIP account and map it to a phone port in the **Phone Device** screen. To access this screen, click the **Add New Account** button or click the **Edit** icon of an entry in the **VoIP > SIP > SIP Account** screen.

Note: You do not necessarily need to use all these fields to set up your account.

Figure 231 VoIP > SIP > SIP Account > Add Account or Edit

**Add New Account**

**SIP Account Selection**  
SIP Account Selection: ChangeMe

**SIP Service Provider Association**  
SIP Account Associated with: ChangeMe

**General**  
 Enable SIP Account  
SIP Account Number: ChangeMe

**Authentication**  
Username: ChangeMe  
Password: \*\*\*\*\*

**URL Type**  
URL Type: SIP

**Voice Features**  
Primary Compression Type: G.711u  
Secondary Compression Type: G.711a  
Third Compression Type: G.722  
Speaking Volume Control: Middle  
Listening Volume Control: Middle  
 Enable G.168 (Echo Cancellation)  
 Enable VAD (Voice Active Detector)

Figure 232 VoIP &gt; SIP &gt; SIP Account &gt; Add Account or Edit (Call Features)

### Call Features

Send Caller ID

Enable Call Transfer

Enable Call Waiting

Call Waiting Reject Timer:  (10~60) Second

Enable Unconditional Forward To Number:

Enable Busy Forward To Number:

Enable No Answer Forward To Number:

No Answer Time:  (10~119) Second

**Caution:**  
If you enable [Unconditional Forward], [Busy Forward] and [No Answer] will be ignored.

Enable Do Not Disturb (DND)

**Warning:**  
If you enable this item, you will not get indication when somebody call you.

Active Incoming Anonymous Call Block

Enable MWI

MWI Subscribe Expiration Time:  (120-86400)Second

Hot Line / Warm Line Number

Warm Line     Hot Line

Hot Line / Warm Line Number:

Warm Line Timer:  (5~300) Second

Enable Missed Call Email Notification

Mail Account:

Send Notification to e-mail:

Missed Call e-mail Title:

**Notice:**  
Please configure mail server in "Maintenance > e-mail Notification" page and select the mail server for this feature.

Early Media

IVR Play Index:

Music On Hold (MOH)

IVR Play Index:

VoIPThe following table describes the labels in this screen.

Table 150 VoIP > SIP > SIP Account > SIP Account Entry Edit

LABEL	DESCRIPTION
SIP Account Selection	
SIP Account Selection	This field displays <b>ChangeMe</b> if you are creating a new SIP account or the SIP account you are modifying.
SIP Service Provider Association	
SIP Account Associated with	Select the SIP service provider profile to use for the SIP account you are configuring in this screen. You should already have configured a SIP service provider profile in the <b>SIP Service Provider</b> screen.  This field is read-only when you are modifying an existing SIP account.
General	
Enable SIP Account	Select this if you want the Zyxel Device to use this account. Clear it if you do not want the Zyxel Device to use this account.
SIP Account Number	Enter your SIP number. In the full SIP URI, this is the part before the @ symbol. You can use up to 127 printable characters and spaces.
Authentication	
Username	Enter the user name for registering this SIP account, exactly as it was given to you. You can use up to 95 alphanumeric (0-9, a-z, A-Z), printable special characters and spaces.
Password	Enter the password for registering this SIP account, exactly as it was given to you. You can use up to 95 alphanumeric (0-9, a-z, A-Z), printable special characters and spaces.
URL Type	
URL Type	Select whether or not to include the SIP service domain name when the Zyxel Device sends the SIP number.  <b>SIP</b> – include the SIP service domain name.  <b>TEL</b> – do not include the SIP service domain name.
Voice Features	
Primary/Secondary/Third Compression Type	Select the type of voice coder or decoder (codec) that you want the Zyxel Device to use.  G.711 provides higher voice quality but requires more bandwidth (64 kbps).  <ul style="list-style-type: none"> <li>• <b>G.729</b> provides good sound quality and reduces the required bandwidth to 8 kbps.</li> <li>• <b>G.711a</b> is typically used in Europe.</li> <li>• <b>G.711u</b> is typically used in North America and Japan.</li> <li>• <b>G.726-24</b> operates at 24 kbps.</li> <li>• <b>G.726-32</b> operates at 32 kbps.</li> <li>• <b>G.722</b> operates at 6.3 kbps or 5.3 kbps.</li> </ul> When two SIP devices start a SIP session, they must agree on a codec.  Select the Zyxel Device's first choice for voice coder or decoder.  Select the Zyxel Device's second choice for voice coder or decoder. Select <b>None</b> if you only want the Zyxel Device to accept the first choice.  Select the Zyxel Device's third choice for voice coder or decoder. Select <b>None</b> if you only want the Zyxel Device to accept the first or second choice.
Speaking Volume Control	Select the loudness that the Zyxel Device uses for speech that it sends to the peer device. Choices are <b>Minimum</b> , <b>Middle</b> , and <b>Maximum</b> .



Table 150 VoIP &gt; SIP &gt; SIP Account &gt; SIP Account Entry Edit (continued)

LABEL	DESCRIPTION
Listening Volume Control	Select the loudness that the Zyxel Device uses for speech that it receives from the peer device. Choices are <b>Minimum</b> , <b>Middle</b> , and <b>Maximum</b> .
Enable G. 168 (Echo Cancellation)	Select this if you want to eliminate the echo caused by the sound of your voice reverberating in the telephone receiver while you talk.
Enable VAD (Voice Active Detector)	Select this if the Zyxel Device should stop transmitting when you are not speaking. This reduces the bandwidth the Zyxel Device uses.
Call Features	
Send Caller ID	Select this if you want to send identification when you make VoIP phone calls. Clear this if you do not want to send identification.
Enable Call Transfer	Select this to enable call transfer on the Zyxel Device. This allows you to transfer an incoming call (that you have answered) to another phone.
Enable Call Waiting	Select this to enable call waiting on the Zyxel Device. This allows you to place a call on hold while you answer another incoming call on the same telephone (directory) number.
Call Waiting Reject Timer	Specify a time of seconds that the Zyxel Device waits before rejecting the second call if you do not answer it.
Enable Unconditional Forward	Select this if you want the Zyxel Device to forward all incoming calls to the specified phone number.  Specify the phone number in the <b>To Number</b> field on the right.
Enable Busy Forward	Select this if you want the Zyxel Device to forward incoming calls to the specified phone number if the phone port is busy.  Specify the phone number in the <b>To Number</b> field on the right.  If you have call waiting, the incoming call is forwarded to the specified phone number if you reject or ignore the second incoming call.
Enable No Answer Forward	Select this if you want the Zyxel Device to forward incoming calls to the specified phone number if the call is unanswered. (See <b>No Answer Time</b> .)  Specify the phone number in the <b>To Number</b> field on the right.
No Answer Time	This field is used by the <b>Active No Answer Forward</b> feature.  Enter the number of seconds the Zyxel Device should wait for you to answer an incoming call before it considers the call unanswered.
Enable Do Not Disturb (DND)	Select this to turn the do not disturb feature on. This has the Zyxel Device reject all calls destined to the phone line.
Active Incoming Anonymous Call Block	Select this to have the phone not ring for incoming calls with caller ID deactivated.
Enable MWI	Select this if you want to hear a waiting (beeping) dial tone on your phone when you have at least one voice message. Your VoIP service provider must support this feature.
MWI Subscribe Expiration Time	Keep the default value of this field unless your VoIP service provider tells you to change it. Enter the number of seconds the SIP server should provide the message waiting service each time the Zyxel Device subscribes to the service. Before this time passes, the Zyxel Device automatically subscribes again.
Hot Line / Warm Line Number	Select this to enable the hot line or warm line feature on the Zyxel Device.
Hot Line	Select this to have the Zyxel Device dial the specified hot line number immediately when you pick up the telephone.
Warm Line	Select this to have the Zyxel Device dial the specified warm line number after you pick up the telephone and do not press any keys on the keypad for a period of time.

Table 150 VoIP &gt; SIP &gt; SIP Account &gt; SIP Account Entry Edit (continued)

LABEL	DESCRIPTION
Hot Line / Warm Line Number	Enter the number of the hot line or warm line that you want the Zyxel Device to dial.
Warm Line Timer	Enter a number of seconds that the Zyxel Device waits before dialing the warm line number if you pick up the telephone and do not press any keys on the keypad.
Enable Missed Call Email Notification	Select this option to have the Zyxel Device email you a notification when there is a missed call.
Mail Account	Select a mail account for the email address specified below. If you select <b>None</b> here, email notifications will not be sent through email. You must have configured a mail account already in the <b>Email Notification</b> screen.
Send Notification to e-mail	Notifications are sent to the email address specified in this field. If this field is left blank, notifications will not be sent through email.
Missed Call e-mail Title	Type a title that you want to be in the subject line of the email notifications that the Zyxel Device sends.
Early Media	Select this if you want people to hear a customized recording when they call you.
IVR Play Index	Select the tone you want people to hear when they call you. This field is configurable only when you select <b>Early Media</b> . See <a href="#">Section 25.10 on page 429</a> for information on how to record these tones.
Music On Hold (MOH)	Select this to play a customized recording when you put people on hold.
IVR Play Index	Select the tone to play when you put someone on hold. This field is configurable only when you select <b>Music on Hold</b> . See <a href="#">Section 25.10 on page 429</a> for information on how to record these tones.
OK	Click this to save your changes.
Cancel	Click this to exit this screen without saving.

## 25.4 SIP Service Provider

Use this screen to view the SIP service provider information on the Zyxel Device. A SIP provider offers Internet call services using VoIP technology. You may need to consult your SIP service provider for the following settings.

To access this screen, click **VoIP > SIP > SIP Service Provider**.

Figure 233 VoIP &gt; SIP &gt; SIP Service Provider

#	SIP Service Provider Name	SIP Proxy Server Address	REGISTER Server Address	SIP Service Domain	Modify
1	ChangeMe	ChangeMe	ChangeMe	ChangeMe	

The following table describes the labels in this screen.

Table 151 VoIP > SIP > SIP Service Provider

LABEL	DESCRIPTION
Add New Provider	Click this button to add a new SIP service provider.
#	This is the index number of the entry.
SIP Service Provider Name	This shows the name of the SIP service provider.
SIP Proxy Server Address	This shows the IP address or domain name of the SIP server.
REGISTER Server Address	This shows the IP address or domain name of the SIP register server.
SIP Service Domain	Enter the SIP service domain name. In the full SIP URI, this is the part after the @symbol. You can use up to 127 printable ASCII Extended set characters.
Modify	Click the <b>Edit</b> icon to configure the SIP service provider. Click the <b>Delete</b> icon to delete this SIP service provider from the Zyxel Device.

### 25.4.1 Provider Entry Add/Edit

Use this screen to configure the SIP server information, the numbers for certain phone functions and dialing plan for a SIP service provider.

Click the **Modify** icon next to a profile of SIP service provider settings in the **VoIP > SIP > SIP Service Provider** to open the following screen.


Note: Click this (  ) to see all the fields in the screen. You do not necessarily need to use all these fields to set up your account. Click again to see and configure only the fields needed for this feature.

Figure 234 VoIP &gt; SIP &gt; SIP Service Provider: Add New Provider or Edit

<
**Add New Provider**

**SIP Service Provider Selection**  
Service Provider Selection: ADD\_NEW

**General**

SIP Service Provider:  Enable SIP Service Provider

SIP Service Provider Name:

SIP Local Port:  (1025-65535)

SIP Proxy Server Address:

SIP Proxy Server Port:  (1025-65535)

SIP REGISTRAR Server Address:

SIP REGISTRAR Server Port:  (1025-65535)

SIP Service Domain:

**RFC Support**

PRACK (RFC 3262, Require: 100rel)

**VoIP IOP Flags**

Replace dial digit '#' to '820' in SIP messages

Remove the 'Route' header in SIP messages

**Bound Interface Name**

Bound Interface Name:  AnyWAN  MultiWAN

**Outbound Proxy**

Outbound Proxy Address:

Outbound Proxy Port:  (1025-65535)

Use DHCP Option 120 First

**RTP Port Range**

Start Port:  (1026-65470)

End Port:  (1056-65500)

**SRTP Support**

SRTP Support

Crypto Suite:  (Encryption and Authentication Type)

**DTMF Mode**

DTMF Mode:

**Transport Type**

Transport Type:

**Ignore Direct IP**

Enable  Disable

**FAX Option**

G.711 Fax Passthrough  T.38 Fax Relay

**QoS Tag**

SIP DSCP Mark Setting:  (0-63)

RTP DSCP Mark Setting:  (0-63)

**Timer Setting**

SIP Register Expiration Duration:  (30-65535) second

SIP Register Fail Re-Try Timer:  (30-65535) second

Session Expires (SE):  (100-3600) second

Min-SE:  (10-1800) second

**Dialing Interval Selection**

Dialing Interval Selection:  second

**DNS SRV**

Enable DNS SRV

Cancel

The following table describes the labels in this screen.

Table 152 VoIP > SIP > SIP Service Provider > Add New Provider or Edit

LABEL	DESCRIPTION
SIP Service Provider Selection	
Service Provider Selection	This field displays <b>ADD_NEW</b> if you are creating a new SIP service provider profile or the SIP service provider name you are modifying.
General	
SIP Service Provider	Select this if you want the Zyxel Device to use this SIP provider. Clear it if you do not want the Zyxel Device to use this SIP provider.
SIP Service Provider Name	Enter the name of your SIP service provider.
SIP Local Port	Enter the Zyxel Device's listening port number, if your VoIP service provider gave you one. Otherwise, keep the default value.
SIP Proxy Server Address	Enter the IP address or domain name of the SIP server provided by your VoIP service provider. You can use up to 95 printable characters except [ " ], [ ` ], [ ' ], [ < ], [ > ], [ ^ ], [ \$ ], [   ], [ & ], or [ ; ]. It does not matter whether the SIP server is a proxy, redirect or register server.
SIP Proxy Server Port	Enter the SIP server's listening port number, if your VoIP service provider gave you one. Otherwise, keep the default value.
SIP REGISTRAR Server Address	Enter the IP address or domain name of the SIP register server, if your VoIP service provider gave you one. Otherwise, enter the same address you entered in the <b>SIP Server Address</b> field. You can use up to 95 printable characters except [ " ], [ ` ], [ ' ], [ < ], [ > ], [ ^ ], [ \$ ], [   ], [ & ], or [ ; ].
SIP REGISTRAR Server Port	Enter the SIP register server's listening port number, if your VoIP service provider gave you one. Otherwise, enter the same port number you entered in the <b>SIP Server Port</b> field.
SIP Service Domain	Enter the SIP service domain name. In the full SIP URI, this is the part after the @ symbol. You can use up to 127 printable characters except [ " ], [ ` ], [ ' ], [ < ], [ > ], [ ^ ], [ \$ ], [   ], [ & ], or [ ; ].
RFC Support	
PRACK (RFC 3262, Require: 100rel)	<p>During a call session, there are two types of SIP responses used – final and provisional. Final responses convey the result of a request and require a confirmation response. Provisional responses only convey the request processing progress and does not require a confirmation response, and are therefore considered unreliable.</p> <p>RFC 3262 defines a mechanism to provide reliable transmission of SIP provisional response messages, which convey information on the processing progress of the request. This uses the option tag 100rel and the Provisional Response ACKnowledgement (PRACK) method.</p> <p>Which is, the Zyxel Device includes a SIP Require header field with the option tag 100rel in all INVITE requests. When the Zyxel Device receives a SIP response message indicating that the phone it called is ringing, the Zyxel Device sends a PRACK message to have both sides confirm the message is received.</p> <p>Select this to have the caller require the option tag 100rel to send provisional responses reliably.</p>
VoIP IOP Flags – Select VoIP inter-operability settings.	
Replace dial digit '#' to '%23' in SIP messages	Replace a dial digit "#" with "%23" in the INVITE messages.
Remove the 'Route' header in SIP messages	Remove the 'Route' header in SIP packets.
Bound Interface Name	

Table 152 VoIP &gt; SIP &gt; SIP Service Provider &gt; Add New Provider or Edit (continued)

LABEL	DESCRIPTION
Bound Interface Name	<p>If you select <b>AnyWAN</b>, the Zyxel Device automatically activates the VoIP service when any WAN connection is up.</p> <p>If you select <b>MultiWAN</b>, you also need to select the pre-configured WAN connections. The VoIP service is activated only when one of the selected WAN connections is up.</p>
Outbound Proxy	
Outbound Proxy Address	Enter the IP address or domain name of the SIP outbound proxy server if your VoIP service provider has a SIP outbound server to handle voice calls. This allows the Zyxel Device to work with any type of NAT router and eliminates the need for STUN or a SIP ALG. Turn off any SIP ALG on a NAT router in front of the Zyxel Device to keep it from re-translating the IP address (since this is already handled by the outbound proxy server).
Outbound Proxy Port	Enter the SIP outbound proxy server's listening port, if your VoIP service provider gave you one. Otherwise, keep the default value.
Use DHCP Option 120 first	Select this to have the Zyxel Device use DHCP Option 120 first.
RTP Port Range	
Start/End Port	<p>Enter the listening port numbers for RTP traffic, if your VoIP service provider gave you this information. Otherwise, keep the default values.</p> <p>To enter one port number, enter the port number in the <b>Start Port</b> and <b>End Port</b> fields.</p> <p>To enter a range of ports,</p> <ul style="list-style-type: none"> <li>enter the port number at the beginning of the range in the <b>Start Port</b> field.</li> <li>enter the port number at the end of the range in the <b>End Port</b> field.</li> </ul>
DTMF Mode	<p>Control how the Zyxel Device handles the tones that your telephone makes when you push its buttons. You should use the same mode your VoIP service provider uses.</p> <p><b>RFC2833</b> – send the DTMF tones in RTP packets.</p> <p><b>PCM</b> – send the DTMF tones in the voice data stream. This method works best when you are using a codec that does not use compression (like G.711). Codecs that use compression (like G.729 and G.726) can distort the tones.</p> <p><b>SIP INFO</b> – send the DTMF tones in SIP messages.</p>
Transport Type	
Transport Type	<p>Select the protocol used to transport the SIP packets.</p> <p>For <b>UDP</b> and <b>TCP</b>, see the Service appendix for more information on the example services and the required protocol and port number.</p> <p>For more information on <b>TLS</b>, see <a href="#">Section 25.5 on page 423</a>.</p>
Ignore Direct IP	Select <b>Enable</b> to have the connected devices accept SIP requests only from the SIP proxy/register server specified above. SIP requests sent from other IP addresses will be ignored.
FAX Option	This field controls how the Zyxel Device handles fax messages.
QoS Tag	
SIP DSCP Mark Setting	Enter the DSCP (DiffServ Code Point) number for SIP message transmissions. The Zyxel Device creates Class of Service (CoS) priority tags with this number to SIP traffic that it transmits.
RTP DSCP Mark Setting	Enter the DSCP (DiffServ Code Point) number for RTP voice transmissions. The Zyxel Device creates Class of Service (CoS) priority tags with this number to RTP traffic that it transmits.
Timer Setting	

Table 152 VoIP &gt; SIP &gt; SIP Service Provider &gt; Add New Provider or Edit (continued)

LABEL	DESCRIPTION
SIP Register Expiration Duration	Enter the number of seconds your SIP account is registered with the SIP register server before it is deleted. The Zyxel Device automatically tries to re-register your SIP account when one-half of this time has passed (The SIP register server might have a different expiration).
SIP Register Fall Re-try timer	Enter the number of seconds the Zyxel Device waits before it tries again to register the SIP account, if the first try failed or if there is no response.
Session Expires [SE]	Enter the number of seconds the Zyxel Device lets a SIP session remain idle (without traffic) before it automatically disconnects the session.
Min-SE	Enter the minimum number of seconds the Zyxel Device lets a SIP session remain idle (without traffic) before it automatically disconnects the session. When two SIP devices start a SIP session, they must agree on an expiration time for idle sessions. This field is the shortest expiration time that the Zyxel Device accepts.
Dialing Interval Selection	
Dialing Interval Selection	Enter the number of seconds the Zyxel Device should wait after you stop dialing numbers before it makes the phone call. The value depends on how quickly you dial phone numbers.
SIP Server Location DNS Method	<p>Select the method that the Zyxel Device used to query the ISP's DNS server for SIP server address. The Zyxel Device will use the query result to locate the SIP server for phone service registration.</p> <p>Select <b>BASIC</b> to have the Zyxel Device query the DNS server for a DNS A record that contains the IP address of the SIP server.</p> <p>Select <b>SRV</b> to have the Zyxel Device query the DNS server for a DNS Service (SRV) record. The SRV record is a list of all available SIP servers information that the DNS server maintains. The Zyxel Device will then use the SRV record to perform A query to get the SIP server IP. This is useful if your primary SIP server experiences difficulties, making it hard for your IP phone users to make SIP calls.</p> <p>Select <b>NAPTR</b> to have the Zyxel Device query the DNS server for DNS Name Authority Pointer (NAPTR) records in order to find the available services (transport protocols) supported by the SIP server. The Zyxel Device will then perform an SRV or A query to get the SIP server information.</p>
OK	Click this to save your changes.
Cancel	Click this to exit this screen without saving.

## 25.5 SIP TLS Common

Note:

To access this screen, click **VoIP > SIP > SIP TLS Common**.

**Figure 235** VoIP > SIP > SIP TLS Common

The following table describes the labels in this screen.

Table 153 VoIP &gt; SIP &gt; SIP TLS Common

LABEL	DESCRIPTION
TLS Local Port	Port 5061 is typically used for SIP over TLS. Enter the Zyxel Device's TLS local port number if your VoIP service provider gave you one. Otherwise, keep the default value.
Local Certificate	This is the certificate the SIP server uses to verify the Zyxel Device. Go to <b>Certificate &gt; Local Certificate</b> and import a Zyxel Device certificate that the SIP server can use to verify the Zyxel Device, if required. Then select the certificate you imported in this field.
Verify Server Certificate	Click to enable this if you want the Zyxel Device to verify the certificate from the SIP server. If required or if your VoIP service provider gave you a certificate, import the dedicated CA in <b>Certificate &gt; Trusted CA</b> in order for the Zyxel Device to authenticate the SIP server.

## 25.6 Phone

Use these screens to configure SIP numbers and regions for IP phones that are connected to the Zyxel Device.

### 25.6.1 Phone Device

Use this screen to view detailed information on phones used for Internet phone calls (SIP). You can define which phones will ring when a specific SIP address receives an incoming call, and which SIP address will be used when an outgoing call is made with a specific phone.

To access this screen, click **VoIP > Phone > Phone Device**.



Figure 236 VoIP &gt; Phone &gt; Phone Device

### Phone

**Phone Device**

Use this screen to view detailed information on phones used for Internet phone calls (SIP). You can define which phone(s) will ring when a specific SIP address receives an incoming call, and which SIP address will be used when an outgoing call is made with a specific phone.

**Analog Phone**

#	Phone ID	Internal Number	Incoming SIP Number	Outgoing SIP Number	Modify
1	PHONE1	**11	ChangeMe	ChangeMe	✎
2	PHONE2	**12	ChangeMe	ChangeMe	✎

Each field is described in the following table.

Table 154 VoIP &gt; Phone &gt; Phone Device

LABEL	DESCRIPTION
#	This displays the index number of the phone device.
Phone ID	This field displays the name of a phone port on the Zyxel Device.
Internal Number	This field displays the internal call prefix of a phone port on the Zyxel Device.
Incoming SIP Number	This field displays the SIP address that you use to receive calls on this phone port.
Outgoing SIP Number	This field displays the SIP address that you use to make calls on this phone port.
Modify	Click the <b>Edit</b> icon to configure the SIP account.

## 25.6.2 Phone Device Edit

Use this screen to control which SIP account and PSTN line each phone uses. Click an **Edit** icon in **VoIP > Phone > Phone Device** to open the following screen.

Figure 237 VoIP &gt; Phone &gt; Phone Device &gt; Edit

Each field is described in the following table.

Table 155 VoIP &gt; Phone &gt; Phone Device &gt; Edit

LABEL	DESCRIPTION
SIP Account to Make Outgoing Call	Select the SIP account you want to use when making outgoing calls with the analog phone connected to this phone port.
SIP Account(s) to Receive Incoming Call	Select a SIP account if you want to receive phone calls for the selected SIP account on this phone port.  If you select more than one SIP account for incoming calls, there is no way to distinguish between them when you receive phone calls. If you do not select a source for incoming calls, you cannot receive any calls on this phone port.
Immediate Dial Enable	Select this if you want to use the pound key (#) to tell the Zyxel Device to make the phone call immediately, instead of waiting for the number of second you selected in the <b>Dialog Interval Selection</b> field of the <b>VoIP &gt; SIP &gt; SIP Service Provider &gt; Add New Provider</b> or <b>Edit</b> screen.  If you select this, dial the phone number, and then press the pound key. The Zyxel Device makes the call immediately instead of waiting. You can still wait, if you want.
Cancel	Click <b>Cancel</b> to exit this screen without saving
OK	Click <b>OK</b> to save your changes.

## 25.7 Phone Region

Use this screen to configure settings that depend on which region of the world the Zyxel Device is in. Selecting the region where the device is physically located improves the quality of phone calls.

To access this screen, click **VoIP > Phone > Region**.

**Figure 238** VoIP > Phone > Region

Phone Device **Region**

Use this screen to configure settings that depend on which region of the world the Zyxel Device is in. Selecting the region where the device is physically located improves the quality of phone calls.

Region Setting: NOR - Norway

Call Service Mode: Europe Type

Note  
You need to reboot the device after changing the region settings for it to take effect.

Cancel Apply

The following table describes the labels in this screen.

Table 156 VoIP > Phone > Region

LABEL	DESCRIPTION
Region Setting	Select the place in which the Zyxel Device is located.
Call Service Mode	Select the mode for supplementary phone services (call hold, call waiting, call transfer and three-way conference calls) that your VoIP service provider supports. <ul style="list-style-type: none"> <li>• <b>Europe Type</b> – use supplementary phone services in European mode.</li> <li>• <b>USA Type</b> – use supplementary phone services American mode.</li> </ul> You might have to subscribe to these services to use them. Contact your VoIP service provider.
Apply	Click this to save your changes and to apply them to the Zyxel Device.
Cancel	Click this to set every field in this screen to its last-saved value.

Note: You need to reboot the Zyxel Device after changing the region settings for it to take effect.

## 25.8 Call Rule

Use this screen to add, edit, or remove speed-dial numbers for outgoing calls. Speed dial provides shortcuts for dialing frequently-used (VoIP) phone numbers. You also have to create speed-dial entries if you want to call SIP numbers that contain letters. Once you have configured a speed dial rule, you can use a shortcut (the speed dial number, #01 for example) on your phone's keypad to call the phone number. To access this screen, click **VoIP > Call Rule**.

Figure 239 VoIP &gt; Call Rule

**Call Rule**

Use this screen to add, edit, or remove speed-dial numbers for outgoing calls. Speed dial provides shortcuts for dialing frequently-used (VoIP) phone numbers. You also have to create speed-dial entries if you want to call SIP addresses that contain letters. Once you have configured a speed dial rule, you can use a shortcut (the speed dial number, #01 for example) on your phone's keypad to call the phone number.

**Clear All Speed Dials**

Keys	Number	Description
#01	<input type="text"/>	<input type="text"/>
#02	<input type="text"/>	<input type="text"/>
#03	<input type="text"/>	<input type="text"/>
#04	<input type="text"/>	<input type="text"/>
#05	<input type="text"/>	<input type="text"/>
#06	<input type="text"/>	<input type="text"/>
#07	<input type="text"/>	<input type="text"/>
#08	<input type="text"/>	<input type="text"/>
#09	<input type="text"/>	<input type="text"/>
#10	<input type="text"/>	<input type="text"/>

**Cancel**      **Apply**

The following table describes the labels in this screen.

Table 157 VoIP &gt; Call Rule

LABEL	DESCRIPTION
Keys	This field displays the speed-dial number you should dial to use this entry.
Number	Enter the SIP number you want the Zyxel Device to call when you dial the speed-dial number.
Description	Enter a short description to identify the party you call when you dial the speed-dial number. You can use up to 127 printable characters except [ " ], [ ` ], [ ' ], [ < ], [ > ], [ ^ ], [ \$ ], [   ], [ & ], or [ ; ]. Spaces are allowed.
Clear All Speed Dials	Click this button to remove all speed dials saved.
Apply	Click this to save your changes and to apply them to the Zyxel Device.
Cancel	Click this to set every field in this screen to its last-saved value.

## 25.9 Call History

The Zyxel Device logs calls from or to your SIP addresses. This screen allows you to view a summary of received, dialed and missed calls and a call history list. You can also view detailed information on each outgoing and incoming call.

To access this screen, click **VoIP > Call History**.

Figure 240 VoIP &gt; Call History

The Zyxel Device logs calls from or to your SIP addresses. This screen allows you to view the summary of received, dialed and missed calls and a call history list. You can also see detailed information for each outgoing call you made or each incoming call from someone calling you. The Zyxel Device stores up to 300 incoming call logs and 300 outgoing call logs. If the number of entries exceed the maximum value, the earliest log of that type will be deleted.

[Clear](#) [Refresh](#)

**Summary**

Date	Total Calls	Outgoing Calls	Incoming Calls	Missing Calls	Total Duration(hh:mm:ss)
------	-------------	----------------	----------------	---------------	--------------------------

Classify

Incoming Outgoing Missed

Type	Date/Time	Peer Number	Phone Number	Duration (hh:mm:ss)	Delete
------	-----------	-------------	--------------	---------------------	--------

Each field is described in the following table.

Table 158 VoIP &gt; Call History

LABEL	DESCRIPTION
Clear	Click this button to remove all entries from the call history list.
Refresh	Click this button to renew the call history list.
Summary	
Date	This is the date when the calls were made.
Total Calls	This displays the total number of calls from or to your SIP addresses that day.
Outgoing Calls	This displays how many calls originated from you that day.
Incoming Calls	This displays how many calls you received that day.
Missing Calls	This displays how many incoming calls were not answered that day.
Total Duration (hh:mm:ss)	This displays how long all calls lasted that day.
Classify	Select the type of the calls. The call types are: <b>All</b> , <b>Incoming</b> , <b>Outgoing</b> and <b>Missed</b> .
Type	This displays the type of the calls.
Date/Time	This displays the date and time when the calls were made.
Peer Number	This displays the SIP address that called you or you called.
Phone Number	This displays the phone number of the call.
Duration (hh:mm:ss)	This displays how long the call lasted.
Delete	Click the <b>Delete</b> icon to remove the call history.

## 25.10 Technical Reference

This section contains background material relevant to the **VoIP** screens.

## VoIP

VoIP is the sending of voice signals over Internet Protocol. This allows you to make phone calls and send faxes over the Internet at a fraction of the cost of using the traditional circuit-switched telephone network. You can also use servers to run telephone service applications like PBX services and voice mail. Internet Telephony Service Provider (ITSP) companies provide VoIP service.

Circuit-switched telephone networks require 64 kilobits per second (Kbps) in each direction to handle a telephone call. VoIP can use advanced voice coding techniques with compression to reduce the required bandwidth.

## SIP

The Session Initiation Protocol (SIP) is an application-layer control (signaling) protocol that handles the setting up, altering and tearing down of voice and multimedia sessions over the Internet.

SIP signaling is separate from the media for which it handles sessions. The media that is exchanged during the session can use a different path from that of the signaling. SIP handles telephone calls and can interface with traditional circuit-switched telephone networks.

## SIP Identities

A SIP account uses an identity (sometimes referred to as a SIP address). A complete SIP identity is called a SIP URI (Uniform Resource Identifier). A SIP account's URI identifies the SIP account in a way similar to the way an email address identifies an email account. The format of a SIP identity is SIP-Number@SIP-Service-Domain.

## SIP Number

The SIP number is the part of the SIP URI that comes before the "@" symbol. A SIP number can use letters like in an email address (johndoe@your-ITSP.com for example) or numbers like a telephone number (1122334455@VoIP-provider.com for example).

## SIP Service Domain

The SIP service domain of the VoIP service provider is the domain name in a SIP URI. For example, if the SIP address is [1122334455@VoIP-provider.com](mailto:1122334455@VoIP-provider.com), then "VoIP-provider.com" is the SIP service domain.

## SIP Registration

Each Zyxel Device is an individual SIP User Agent (UA). To provide voice service, it has a public IP address for SIP and RTP protocols to communicate with other servers.

A SIP user agent has to register with the SIP registrar and must provide information about the users it represents, as well as its current IP address (for the routing of incoming SIP requests). After successful registration, the SIP server knows that the users (identified by their dedicated SIP URIs) are represented by the UA, and knows the IP address to which the SIP requests and responses should be sent.

Registration is initiated by the User Agent Client (UAC) running in the VoIP gateway (the Zyxel Device). The gateway must be configured with information letting it know where to send the REGISTER message, as well as the relevant user and authorization data.

A SIP registration has a limited lifespan. The User Agent Client must renew its registration within this lifespan. If it does not do so, the registration data will be deleted from the SIP registrar's database and the connection broken.

The Zyxel Device attempts to register all enabled subscriber ports when it is switched on. When you enable a subscriber port that was previously disabled, the Zyxel Device attempts to register the port immediately.

## Authorization Requirements

SIP registrations (and subsequent SIP requests) require a username and password for authorization. These credentials are validated through a challenge / response system using the HTTP digest mechanism (as detailed in RFC 3261, "SIP: Session Initiation Protocol").

## SIP Servers

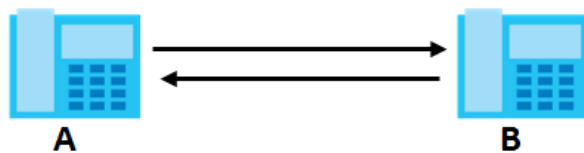
SIP is a client-server protocol. A SIP client is an application program or device that sends SIP requests. A SIP server responds to the SIP requests.

When you use SIP to make a VoIP call, it originates at a client and terminates at a server. A SIP client could be a computer or a SIP phone. One device can act as both a SIP client and a SIP server.

## SIP User Agent

A SIP user agent can make and receive VoIP telephone calls. This means that SIP can be used for peer-to-peer communications even though it is a client-server protocol. In the following figure, either **A** or **B** can act as a SIP user agent client to initiate a call. **A** and **B** can also both act as a SIP SIP user agent to receive the call.

Figure 241 SIP User Agent



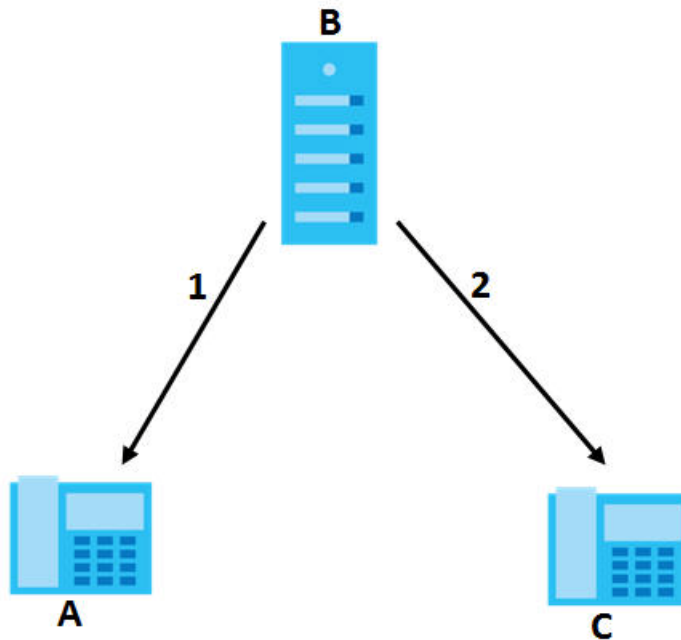
## SIP Proxy Server

A SIP proxy server receives requests from clients and forwards them to another server.

In the following example, you want to use client device **A** to call someone who is using client device **C**.

- 1 The client device (**A** in the figure) sends a call invitation to the SIP proxy server (**B**).
- 2 The SIP proxy server forwards the call invitation to **C**.

Figure 242 SIP Proxy Server



### SIP Redirect Server

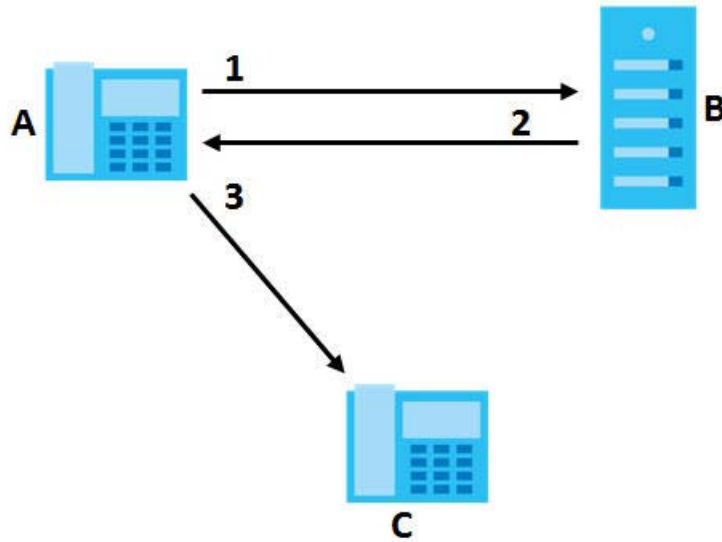
A SIP redirect server accepts SIP requests, translates the destination address to an IP address and sends the translated IP address back to the device that sent the request. Then the client device that originally sent the request can send requests to the IP address that it received back from the redirect server. Redirect servers do not initiate SIP requests.

In the following example, you want to use client device **A** to call someone who is using client device **C**.

- 1 Client device **A** sends a call invitation for **C** to the SIP redirect server (**B**).
- 2 The SIP redirect server sends the invitation back to **A** with **C**'s IP address (or domain name).
- 3 Client device **A** then sends the call invitation to client device **C**.



Figure 243 SIP Redirect Server



## SIP Register Server

A SIP register server maintains a database of SIP identity-to-IP address (or domain name) mapping. The register server checks your user name and password when you register.

## RTP

When you make a VoIP call using SIP, the RTP (Real time Transport Protocol) is used to handle voice data transfer. See RFC 1889 for details on RTP.

## Pulse Code Modulation

Pulse Code Modulation (PCM) measures analog signal amplitudes at regular time intervals and converts them into bits.

## SIP Call Progression

The following figure displays the basic steps in the setup and tear down of a SIP call. A calls B.

Table 159 SIP Call Progression

A		B
1. INVITE	→	
	←	2. Ringing
	←	3. OK
4. ACK	→	
		5. Dialogue (voice traffic)
6. BYE	→	
	←	7. OK

- 1 **A** sends a SIP INVITE request to **B**. This message is an invitation for **B** to participate in a SIP telephone call.
- 2 **B** sends a response indicating that the telephone is ringing.
- 3 **B** sends an OK response after the call is answered.
- 4 **A** then sends an ACK message to acknowledge that **B** has answered the call.
- 5 Now **A** and **B** exchange voice media (talk).
- 6 After talking, **A** hangs up and sends a BYE request.
- 7 **B** replies with an OK response confirming receipt of the BYE request and the call is terminated.

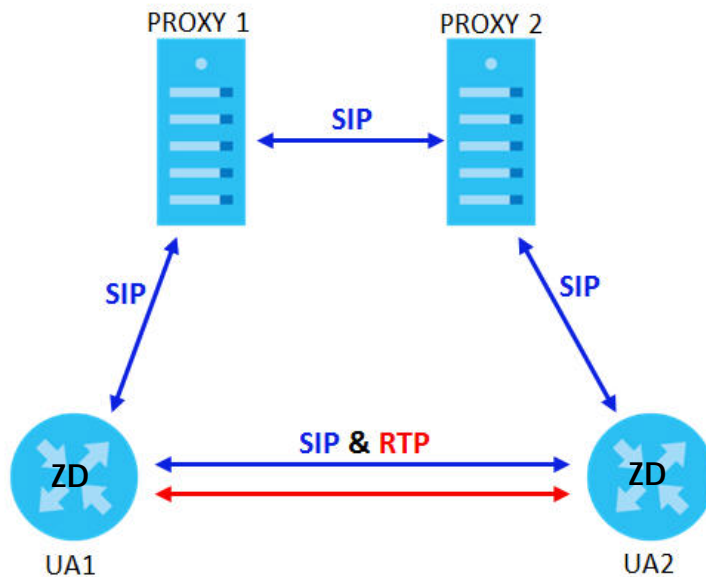
### SIP Call Progression Through Proxy Servers

Usually, the SIP UAC sets up a phone call by sending a request to the SIP proxy server. Then, the proxy server looks up the destination to which the call should be forwarded (according to the URI requested by the SIP UAC). The request may be forwarded to more than one proxy server before arriving at its destination.

The response to the request goes to all the proxy servers through which the request passed, in reverse sequence. Once the session is set up, session traffic is sent between the UAs directly, bypassing all the proxy servers in between.

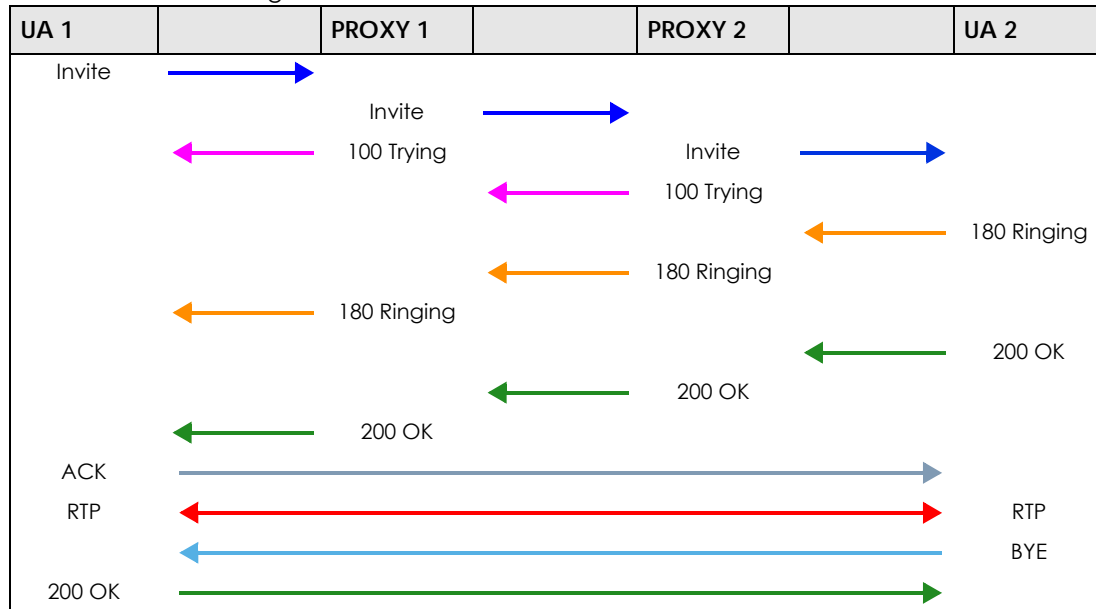
The following figure shows the SIP and session traffic flow between the user agents (**UA 1** and **UA 2**) and the proxy servers (this example shows two proxy servers, **PROXY 1** and **PROXY 2**).

**Figure 244** SIP Call Through Proxy Servers



The following table shows the SIP call progression.

Table 160 SIP Call Progression



- User Agent 1** sends a SIP INVITE request to **Proxy 1**. This message is an invitation to **User Agent 2** to participate in a SIP telephone call. **Proxy 1** sends a response indicating that it is trying to complete the request.
- Proxy 1** sends a SIP INVITE request to **Proxy 2**. **Proxy 2** sends a response indicating that it is trying to complete the request.
- Proxy 2** sends a SIP INVITE request to **User Agent 2**.
- User Agent 2** sends a response back to **Proxy 2** indicating that the phone is ringing. The response is relayed back to **User Agent 1** through **Proxy 1**.
- User Agent 2** sends an OK response to **Proxy 2** after the call is answered. This is also relayed back to **User Agent 1** through **Proxy 1**.
- User Agent 1** and **User Agent 2** exchange RTP packets containing voice data directly, without involving the proxies.
- When **User Agent 2** hangs up, he sends a BYE request.
- User Agent 1** replies with an OK response confirming receipt of the BYE request, and the call is terminated.

## Voice Coding

A codec (coder/decoder) codes analog voice signals into digital signals and decodes the digital signals back into analog voice signals. The Zyxel Device supports the following codecs.

- G.711 is a Pulse Code Modulation (PCM) waveform codec. PCM measures analog signal amplitudes at regular time intervals and converts them into digital samples. G.711 provides very good sound quality but requires 64 kbps of bandwidth.

- G.726 is an Adaptive Differential PCM (ADPCM) waveform codec that uses a lower bitrate than standard PCM conversion. ADPCM converts analog audio into digital signals based on the difference between each audio sample and a prediction based on previous samples. The more similar the audio sample is to the prediction, the less space needed to describe it. G.726 operates at 16, 24, 32 or 40 kbps.
- G.729 is an Analysis-by-Synthesis (AbS) hybrid waveform codec that uses a filter based on information about how the human vocal tract produces sounds. G.729 provides good sound quality and reduces the required bandwidth to 8 kbps.

## Voice Activity Detection/Silence Suppression

Voice Activity Detection (VAD) detects whether or not speech is present. This lets the Zyxel Device reduce the bandwidth that a call uses by not transmitting "silent packets" when you are not speaking.

## Comfort Noise Generation

When using VAD, the Zyxel Device generates comfort noise when the other party is not speaking. The comfort noise lets you know that the line is still connected as total silence could easily be mistaken for a lost connection.

## Echo Cancellation

G.168 is an ITU-T standard for eliminating the echo caused by the sound of your voice reverberating in the telephone receiver while you talk.

## MWI (Message Waiting Indication)

Enable Message Waiting Indication (MWI) enables your phone to give you a message-waiting (beeping) dial tone when you have a voice message(s). Your VoIP service provider must have a messaging system that sends message waiting status SIP packets as defined in RFC 3842.

## Custom Tones (IVR)

IVR (Interactive Voice Response) is a feature that allows you to use your telephone to interact with the Zyxel Device. The Zyxel Device allows you to record custom tones for the **Early Media** and **Music On Hold** functions. The same recordings apply to both the caller ringing and on hold tones.

Table 161 Custom Tones Details

LABEL	DESCRIPTION
Total Time for All Tones	900 seconds for all custom tones combined
Maximum Time per Individual Tone	180 seconds
Total Number of Tones Recordable	5 You can record up to 5 different custom tones but the total time must be 900 seconds or less.

## Recording Custom Tones

Use the following steps if you would like to create new tones or change your tones:

- 1 Pick up the phone and press “\*\*\*\*” on your phone's keypad and wait for the message that says you are in the configuration menu.
- 2 Press a number from 1101~1105 on your phone followed by the “#” key.
- 3 Play your desired music or voice recording into the receiver's mouthpiece. Press the “#” key.
- 4 You can continue to add, listen to, or delete tones, or you can hang up the receiver when you are done.

### Listening to Custom Tones

Do the following to listen to a custom tone:

- 1 Pick up the phone and press “\*\*\*\*” on your phone's keypad and wait for the message that says you are in the configuration menu.
- 2 Press a number from 1201~1208 followed by the “#” key to listen to the tone.
- 3 You can continue to add, listen to, or delete tones, or you can hang up the receiver when you are done.

### Deleting Custom Tones

Do the following to delete a custom tone:

- 1 Pick up the phone and press “\*\*\*\*” on your phone's keypad and wait for the message that says you are in the configuration menu.
- 2 Press a number from 1301~1308 followed by the “#” key to delete the tone of your choice. Press 14 followed by the “#” key if you wish to clear all your custom tones.

You can continue to add, listen to, or delete tones, or you can hang up the receiver when you are done.

## 25.10.1 Quality of Service (QoS)

Quality of Service (QoS) refers to both a network's ability to deliver data with minimum delay, and the networking methods used to provide bandwidth for real-time multimedia applications.

### Type of Service (ToS)

Network traffic can be classified by setting the ToS (Type of Service) values at the data source (for example, at the Zyxel Device) so a server can decide the best method of delivery, that is the least cost, fastest route and so on.

### DiffServ

DiffServ is a class of service (CoS) model that marks packets so that they receive specific per-hop treatment at DiffServ-compliant network devices along the route based on the application types and traffic flow. Packets are marked with DiffServ Code Points (DSCP) indicating the level of service desired.

This allows the intermediary DiffServ-compliant network devices to handle the packets differently depending on the code points without the need to negotiate paths or remember state information for every flow. In addition, applications do not have to request a particular service or give advanced notice of where the traffic is going.<sup>3</sup>

## DSCP and Per-Hop Behavior

DiffServ defines a new DS (Differentiated Services) field to replace the Type of Service (TOS) field in the IP header. The DS field contains a 2-bit unused field and a 6-bit DSCP field which can define up to 64 service levels. The following figure illustrates the DS field.

DSCP is backward compatible with the three precedence bits in the ToS octet so that non-DiffServ compliant, ToS-enabled network device will not conflict with the DSCP mapping.

**Figure 245** DiffServ: Differentiated Service Field

DSCP (6-bit)	Unused (2-bit)
-----------------	-------------------

The DSCP value determines the forwarding behavior, the PHB (Per-Hop Behavior), that each packet gets across the DiffServ network. Based on the marking rule, different kinds of traffic can be marked for different priorities of forwarding. Resources can then be allocated according to the DSCP values and the configured policies.

## 25.10.2 Phone Services Overview

Supplementary services such as call hold, call waiting, and call transfer, are generally available from your VoIP service provider. The Zyxel Device supports the following services:

- Call Return
- Call Hold
- Call Waiting
- Making a Second Call
- Call Transfer
- Call Forwarding
- Three-Way Conference
- Internal Calls
- Call Park and Pickup
- Do not Disturb
- IVR
- Call Completion
- CCBS
- Outgoing SIP

---

3. The Zyxel Device does not support DiffServ at the time of writing.

Note: To take full advantage of the supplementary phone services available through the Zyxel Device's phone ports, you may need to subscribe to the services from your VoIP service provider.

### 25.10.2.1 The Flash Key

Flashing means to press the hook for a short period of time (a few hundred milliseconds) before releasing it. On newer telephones, there should be a "flash" key (button) that generates the signal electronically. If the flash key is not available, you can tap (press and immediately release) the hook by hand to achieve the same effect. However, using the flash key is preferred since the timing is much more precise. With manual tapping, if the duration is too long, it may be interpreted as hanging up by the Zyxel Device.

You can invoke all the supplementary services by using the flash key.

### 25.10.2.2 Europe Type Supplementary Phone Services

This section describes how to use supplementary phone services with the **Europe Type Call Service Mode**. Commands for supplementary services are listed in the table below.

After pressing the flash key, if you do not issue the sub-command before the default sub-command timeout (2 seconds) expires or issue an invalid sub-command, the current operation will be aborted.

Table 162 European Flash Key Commands

COMMAND	SUB-COMMAND	DESCRIPTION
Flash		Put a current call on hold to place a second call. Switch back to the call (if there is no second call).
Flash	0	Drop the call presently on hold or reject an incoming call which is waiting for answer.
Flash	1	Disconnect the current phone connection and answer the incoming call or resume with caller presently on hold.
Flash	2	1. Switch back and forth between two calls. 2. Put a current call on hold to answer an incoming call. 3. Separate the current three-way conference call into two individual calls (one is on-line, the other is on hold).
Flash	3	Create three-way conference connection.
Flash	*98#	Transfer the call to another phone.

### European Call Hold

Call hold allows you to put a call (**A**) on hold by pressing the flash key.

If you have another call, press the flash key and then "2" to switch back and forth between caller **A** and **B** by putting either one on hold.

Press the flash key and then "0" to disconnect the call presently on hold and keep the current call on line.

Press the flash key and then "1" to disconnect the current call and resume the call on hold.

If you hang up the phone but a caller is still on hold, there will be a remind ring.

## European Call Waiting

This allows you to place a call on hold while you answer another incoming call on the same telephone (directory) number.

If there is a second call to a telephone number, you will hear a call waiting tone. Take one of the following actions.

- Reject the second call.  
Press the flash key and then press "0".
- Disconnect the first call and answer the second call.  
Either press the flash key and press "1", or just hang up the phone and then answer the phone after it rings.
- Put the first call on hold and answer the second call.  
Press the flash key and then "2".

## European Call Transfer

Do the following to transfer an incoming call (that you have answered) to another phone.

- 1 Press the flash key to put the caller on hold.
- 2 When you hear the dial tone, dial "\*\*98#" followed by the number to which you want to transfer the call.
- 3 After you hear the ring signal or the second party answers it, hang up the phone.

## European Three-Way Conference

Use the following steps to make three-way conference calls.

- 1 When you are on the phone talking to someone, press the flash key to put the caller on hold and get a dial tone.
- 2 Dial a phone number directly to make another call.
- 3 When the second call is answered, press the flash key and press "3" to create a three-way conversation.
- 4 Hang up the phone to drop the connection.
- 5 If you want to separate the activated three-way conference into two individual connections (one is on-line, the other is on hold), press the flash key and press "2".

### 25.10.2.3 USA Type Supplementary Services

This section describes how to use supplementary phone services with the **USA Type Call Service Mode**. Commands for supplementary services are listed in the table below.



After pressing the flash key, if you do not issue the sub-command before the default sub-command timeout (2 seconds) expires or issue an invalid sub-command, the current operation will be aborted.

Table 163 USA Flash Key Commands

COMMAND	SUB-COMMAND	DESCRIPTION
Flash		Put a current call on hold to place a second call. After the second call is successful, press the flash key again to have a three-way conference call. Put a current call on hold to answer an incoming call.
Flash	*98#	Transfer the call to another phone.

## USA Call Hold

Call hold allows you to put a call (**A**) on hold by pressing the flash key.

If you have another call, press the flash key to switch back and forth between caller **A** and **B** by putting either one on hold.

If you hang up the phone but a caller is still on hold, there will be a remind ring.

## USA Call Waiting

This allows you to place a call on hold while you answer another incoming call on the same telephone (directory) number.

If there is a second call to your telephone number, you will hear a call waiting tone.

Press the flash key to put the first call on hold and answer the second call.

## USA Call Transfer

Do the following to transfer an incoming call (that you have answered) to another phone.

- 1 Press the flash key to put the caller on hold.
- 2 When you hear the dial tone, dial **\*\*98#** followed by the number to which you want to transfer the call.
- 3 After you hear the ring signal or the second party answers it, hang up the phone.

## USA Three-Way Conference

Use the following steps to make three-way conference calls.

- 1 When you are on the phone talking to someone (party A), press the flash key to put the caller on hold and get a dial tone.
- 2 Dial a phone number directly to make another call (to party B).
- 3 When party B answers the second call, press the flash key to create a three-way conversation.
- 4 Hang up the phone to drop the connection.

- 5 If you want to separate the activated three-way conference into two individual connections (with party A on-line and party B on hold), press the flash key.
- 6 If you want to go back to the three-way conversation, press the flash key again.
- 7 If you want to separate the activated three-way conference into two individual connections again, press the flash key. This time the party B is on-line and party A is on hold.

#### 25.10.2.4 Phone Functions Summary

The following table shows the key combinations you can enter on your phone's keypad to use certain features.

Table 164 Phone Functions Summary

ACTION	FUNCTION	DESCRIPTION
*98#	Call transfer	Transfer a call to another phone. See <a href="#">Section 25.10.2.2 on page 439</a> (Europe type) and <a href="#">Section 25.10.2.3 on page 440</a> (USA type).
*66#	Call return	Place a call to the last person who called you.
*95#	Enable Do Not Disturb	Use these to set your phone not to ring when someone calls you, or to turn this function off.
#95#	Disable Do Not Disturb	
*41#	Enable Call Waiting	Use these to allow you to put a call on hold when you are answering another, or to turn this function off.
#41#	Disable Call Waiting	
****	IVR	Use these to set up Interactive Voice Response (IVR). IVR allows you to record custom caller ringing tones (the sound a caller hears before you pick up the phone) and on hold tones (the sound someone hears when you put their call on hold).
####	Internal Call	Call the phone(s) connected to the Zyxel Device.
*82	One Shot Caller Display Call	Activate or deactivate caller ID for the next call only.
*67	One Shot Caller Hidden Call	

# CHAPTER 26

# Log

## 26.1 Log Overview

These screens allow you to determine the categories of events and/or alerts that the Zyxel Device logs and then display these logs or have the Zyxel Device send them to an administrator (through email) or to a syslog server.

### 26.1.1 What You Can Do in this Chapter

- Use the **System Log** screen to see the system logs ([Section 26.2 on page 444](#)).
- Use the **Security Log** screen to see the security-related logs for the categories that you select ([Section 26.3 on page 445](#)).

### 26.1.2 What You Need To Know

The following terms and concepts may help as you read this chapter.

#### Alerts and Logs

An alert is a type of log that warrants more serious attention. They include system errors, attacks (access control) and attempted access to blocked web sites. Some categories such as **System Errors** consist of both logs and alerts. You may differentiate them by their color in the **View Log** screen. Alerts display in red and logs display in black.

#### Syslog Overview

The syslog protocol allows devices to send event notification messages across an IP network to syslog servers that collect the event messages. A syslog-enabled device can generate a syslog message and send it to a syslog server.

Syslog is defined in RFC 3164. The RFC defines the packet format, content and system log related information of syslog messages. Each syslog message has a facility and severity level. The syslog facility identifies a file in the syslog server. Refer to the documentation of your syslog program for details. The following table describes the syslog severity levels.

Table 165 Syslog Severity Levels

CODE	SEVERITY
0	Emergency: The system is unusable.
1	Alert: Action must be taken immediately.
2	Critical: The system condition is critical.
3	Error: There is an error condition on the system.
4	Warning: There is a warning condition on the system.

Table 165 Syslog Severity Levels (continued)

CODE	SEVERITY
5	Notice: There is a normal but significant condition on the system.
6	Informational: The syslog contains an informational message.
7	Debugging: The message is intended for debug-level purposes.

## 26.2 System Log

Use the **System Log** screen to see the system logs. You can filter the entries by selecting a severity level and/or category. Click **System Monitor > Log** to open the **System Log** screen.

Figure 246 System Monitor &gt; Log &gt; System Log

The following table describes the fields in this screen.

Table 166 System Monitor &gt; Log &gt; System Log

LABEL	DESCRIPTION
Level	Select a severity level from the drop-down list box. This filters search results according to the severity level you have selected. When you select a severity, the Zyxel Device searches through all logs of that severity or higher.
Category	Select the type of logs to display.
Clear Log	Click this to delete all the logs.
Refresh	Click this to renew the log screen.
Export Log	Click this to export the selected logs.
E-mail Log Now	Click this to send the log files to the email address you specify in the <b>Maintenance &gt; Log Setting</b> screen.
#	This field is a sequential value and is not associated with a specific entry.
Time	This field displays the time the log was recorded.
Facility	The log facility allows you to send logs to different files in the syslog server. Refer to the documentation of your syslog program for more details.
Level	This field displays the severity level of the log that the Zyxel Device is to send to this syslog server.
Category	This field displays the type of the log.
Messages	This field states the reason for the log.

## 26.3 Security Log

Use the **Security Log** screen to see the security-related logs for the categories that you select. You can filter the entries by selecting a severity level and/or category. Click **System Monitor > Log > Security Log** to open the following screen.

**Figure 247** System Monitor > Log > Security Log

The screenshot shows the 'Security Log' interface. At the top, there is a breadcrumb 'System Log > Security Log'. Below it is a text box with instructions: 'Use the Security Log screen to see the security-related logs for the categories that you select. You can filter the entries by selecting a severity level and/or category.' Below the text box are two dropdown menus: 'Level' set to 'All' and 'Category' set to 'All'. To the right of these are four buttons: 'Clear Log', 'Refresh', 'Export Log', and 'E-mail Log Now'. Below the filters is a table header with columns: '#', 'Time', 'Facility', 'Level', 'Category', and 'Messages'.

The following table describes the fields in this screen.

**Table 167** System Monitor > Log > Security Log

LABEL	DESCRIPTION
Level	Select a severity level from the drop-down list box. This filters search results according to the severity level you have selected. When you select a severity, the Zyxel Device searches through all logs of that severity or higher.
Category	Select the type of logs to display.
Clear Log	Click this to delete all the logs.
Refresh	Click this to renew the log screen.
Export Log	Click this to export the selected logs.
E-mail Log Now	Click this to send the log files to the email address you specify in the <b>Maintenance &gt; Log Setting</b> screen.
#	This field is a sequential value and is not associated with a specific entry.
Time	This field displays the time the log was recorded.
Facility	The log facility allows you to send logs to different files in the syslog server. Refer to the documentation of your syslog program for more details.
Level	This field displays the severity level of the log that the Zyxel Device is to send to this syslog server.
Category	This field displays the type of the log.
Messages	This field states the reason for the log.

# CHAPTER 27

## Traffic Status

### 27.1 Traffic Status Overview

Use the **Traffic Status** screens to look at the network traffic status and statistics of the WAN/LAN interfaces and NAT.

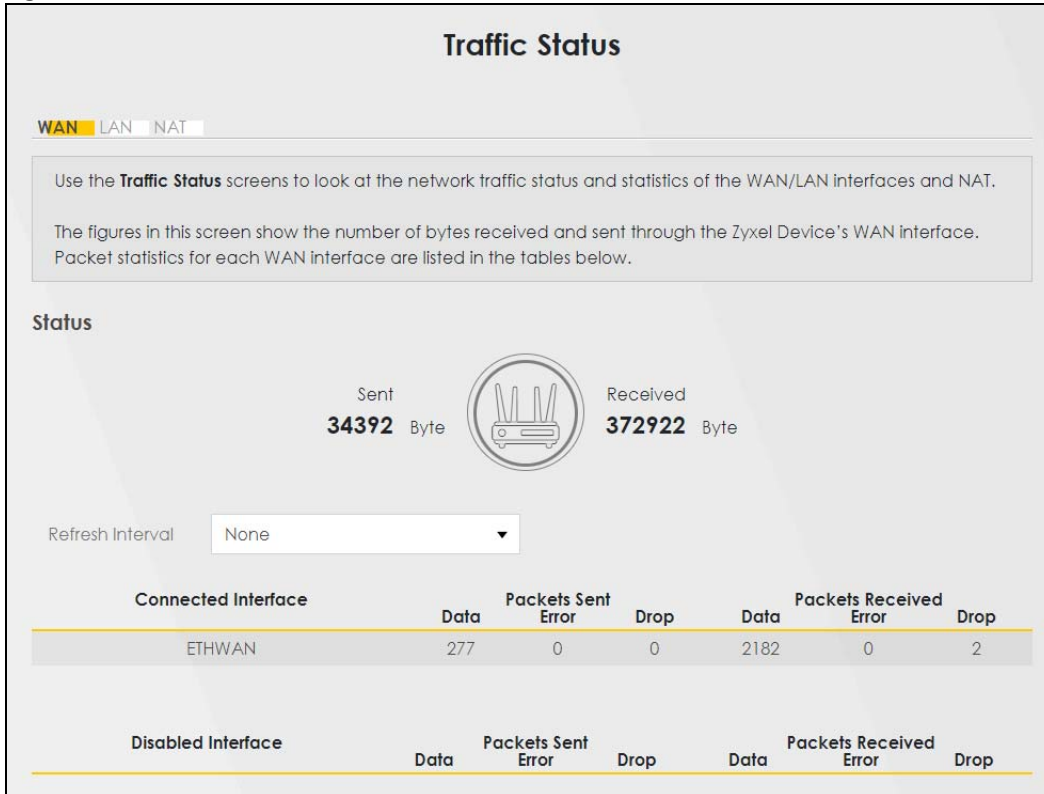
#### 27.1.1 What You Can Do in this Chapter

- Use the **WAN** screen to view the WAN traffic statistics ([Section 27.2 on page 446](#)).
- Use the **LAN** screen to view the LAN traffic statistics ([Section 27.3 on page 448](#)).
- Use the **NAT** screen to view the NAT status of the Zyxel Device's clients ([Section 27.4 on page 449](#)).

### 27.2 WAN Status

Click **System Monitor > Traffic Status** to open the **WAN** screen. The figures in this screen show the number of bytes received and sent through the Zyxel Device's WAN interface. The table below shows packet statistics for each WAN interface.

Figure 248 System Monitor &gt; Traffic Status &gt; WAN



The following table describes the fields in this screen.

Table 168 System Monitor &gt; Traffic Status &gt; WAN

LABEL	DESCRIPTION
Refresh Interval	Select how often you want the Zyxel Device to update this screen.
Connected Interface	This shows the name of the WAN interface that is currently connected.
Packets Sent	
Data	This indicates the number of transmitted packets on this interface.
Error	This indicates the number of frames with errors transmitted on this interface.
Drop	This indicates the number of outgoing packets dropped on this interface.
Packets Received	
Data	This indicates the number of received packets on this interface.
Error	This indicates the number of frames with errors received on this interface.
Drop	This indicates the number of received packets dropped on this interface.
Disabled Interface	This shows the name of the WAN interface that is currently disabled.
Packets Sent	
Data	This indicates the number of transmitted packets on this interface.
Error	This indicates the number of frames with errors transmitted on this interface.
Drop	This indicates the number of outgoing packets dropped on this interface.
Packets Received	
Data	This indicates the number of received packets on this interface.

Table 168 System Monitor &gt; Traffic Status &gt; WAN (continued)

LABEL	DESCRIPTION
Error	This indicates the number of frames with errors received on this interface.
Drop	This indicates the number of received packets dropped on this interface.

## 27.3 LAN Status

Click **System Monitor > Traffic Status > LAN** to open the following screen. This screen allows you to view packet statistics for each LAN or WLAN interface on the Zyxel Device.

Figure 249 System Monitor &gt; Traffic Status &gt; LAN

The screenshot shows the 'Traffic Status' page with the 'LAN' tab selected. It includes a refresh interval dropdown set to 'None' and two tables of statistics for interfaces LAN1, LAN2, LAN3, LAN4, 10G LAN, 2.4G WLAN, and 5G WLAN.

Interface	LAN1	LAN2	LAN3	LAN4	10G LAN	2.4G WLAN	5G WLAN
Bytes Sent	14373042	0	0	0	0	7718440	32324333
Bytes Received	3094454	0	0	0	0	540127	3624349

Interface	LAN1	LAN2	LAN3	LAN4	10G LAN	2.4G WLAN	5G WLAN
Sent (Packet)	Data	39246	0	0	0	39300	85541
	Error	0	0	0	0	20	12
	Drop	0	0	0	0	0	4
Received (Packet)	Data	23658	0	0	0	2668	15754
	Error	0	0	0	0	8	43
	Drop	0	0	0	0	0	0

The following table describes the fields in this screen.

Table 169 System Monitor &gt; Traffic Status &gt; LAN

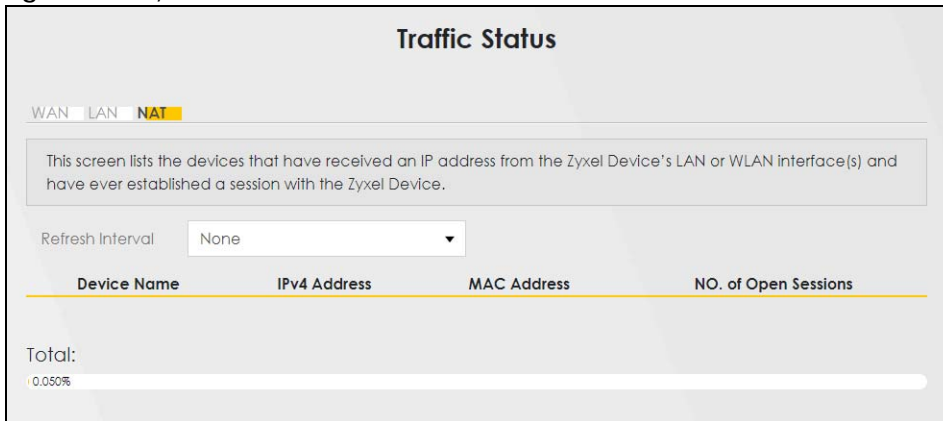
LABEL	DESCRIPTION
Refresh Interval	Select how often you want the Zyxel Device to update this screen.
Interface	This shows the LAN or WLAN interface.
Bytes Sent	This indicates the number of bytes transmitted on this interface.
Bytes Received	This indicates the number of bytes received on this interface.
Interface	This shows the LAN or WLAN interfaces.
Sent (Packets)	
Data	This indicates the number of transmitted packets on this interface.
Error	This indicates the number of frames with errors transmitted on this interface.
Drop	This indicates the number of outgoing packets dropped on this interface.
Received (Packets)	
Data	This indicates the number of received packets on this interface.
Error	This indicates the number of frames with errors received on this interface.
Drop	This indicates the number of received packets dropped on this interface.



## 27.4 NAT Status

Click **System Monitor > Traffic Status > NAT** to open the following screen. This screen lists the devices that have received an IP address from the Zyxel Device LAN or WLAN interfaces and have ever established a session with the Zyxel Device.

**Figure 250** System Monitor > Traffic Status > NAT



The following table describes the fields in this screen.

**Table 170** System Monitor > Traffic Status > NAT

LABEL	DESCRIPTION
Refresh Interval	Select how often you want the Zyxel Device to update this screen.
Device Name	This displays the name of the connected host.
IPv4 Address	This displays the IP address of the connected host.
MAC Address	This displays the MAC address of the connected host.
No. of Open Sessions	This displays the number of NAT sessions currently opened for the connected host.
Total	This displays what percentage of NAT sessions the Zyxel Device can support is currently being used by all connected hosts. You can also see the number of active NAT sessions and the maximum number of NAT sessions the Zyxel Device can support

# CHAPTER 28

## VoIP Status

### 28.1 VoIP Status Screen

Click **System Monitor > VoIP Status** to open the following screen. You can view the Voice over IP (VoIP) registration, current call status and phone numbers in this screen.

**Figure 251** System Monitor > VoIP Status

Information, such as whether a SIP account is registered and the total call volume made by a SIP account, can be viewed in the page.

Poll Interval  sec [Set Interval](#) [Stop](#)

(s)

#### SIP Status

Account	Register Action	Registration	Registration Time	URI	Message Waiting	Last Incoming Number	Last Outgoing Number
1	<input type="checkbox"/>	Disabled		ChangeMe@ChangeMe	No		

#### Call Status

Account	Duration	Status	Call Type	Codec	From Phone Port Type	To Phone Port Type	Peer Number

#### Phone Status

Phone	Outgoing Number	Incoming Number	Hook Status
Phone 1	ChangeMe	ChangeMe	On-hook

The following table describes the labels in this screen.

**Table 171** System Monitor > VoIP Status

LABEL	DESCRIPTION
Poll Interval	Enter the number of seconds the Device needs to wait before updating this screen and then click <b>Set Interval</b> . Click <b>Stop</b> to have the Device stop updating this screen.
SIP Status	
Account	This column displays each SIP account in the Device.
Register Action	Click on this switch to register/unregister the SIP account. This switch will turn blue if a registration attempt is successful; otherwise, it will revert to its unregistered setting. Unregistering an account does not delete the SIP account itself, but removes the mapping between your SIP identity and your IP address or domain name.

Table 171 System Monitor &gt; VoIP Status (continued)

LABEL	DESCRIPTION
Registration	<p>This field displays the current registration status of the SIP account.</p> <p><b>Registered</b> - The SIP account is activated and has been registered with a SIP server. You can use it to make a VoIP call.</p> <p><b>Unregistered</b> - The SIP account is activated, but the last time the Zyxel Device tried to register the SIP account with the SIP server, the attempt failed. Use the <b>Register Action</b> switch to register the account again. The Zyxel Device will also automatically try to register the SIP account again after a period of time that you configured in <b>VoIP &gt; SIP &gt; SIP Service Provider &gt; Add/Edit &gt; SIP Register Fail Re-Try Timer</b>.</p> <p><b>Disabled</b> - The SIP account is not active. Make sure the corresponding SIP Service Provider and SIP Account are both enabled in <b>VoIP &gt; SIP &gt; SIP Service Provider &gt; Add/Edit</b> and <b>VoIP &gt; SIP &gt; SIP Account &gt; Add/Edit</b>.</p>
Registration Time	This field displays the last time the Device successfully registered the SIP account. The field is blank if the Device has never successfully registered this account.
URI	This field displays the account number and service domain of the SIP account. You can change these in the <b>VoIP &gt; SIP</b> screen.
Message Waiting	This field indicates whether or not there are any messages waiting for the SIP account.
Last Incoming Number	This field displays the last number that called the SIP account. The field is blank if no number has ever dialed the SIP account.
Last Outgoing Number	This field displays the last number the SIP account called. The field is blank if the SIP account has never dialed a number.
Call Status	
Account	This column displays each SIP account in the Device.
Duration	This field displays how long the current call has lasted.
Status	<p>This field displays the current state of the phone call.</p> <p><b>Idle</b> – There are no current VoIP calls, incoming calls or outgoing calls being made.</p> <p><b>Dial</b> – The callee's phone is ringing.</p> <p><b>Ring</b> – The phone is ringing for an incoming VoIP call.</p> <p><b>Process</b> – There is a VoIP call in progress.</p> <p><b>DISC</b> – The callee's line is busy, the callee hung up or your phone was left off the hook.</p>

Table 171 System Monitor &gt; VoIP Status (continued)

LABEL	DESCRIPTION
Call Type	<p>This field displays the call direction type of the current VoIP call. <b>Outgoing Call</b> – It is a SIP VoIP call made by local phone ports, and this SIP account is able to issue a (SIP-based) call setup to the SIP account of remote peers for a VoIP call establishment. This (SIP-based) call setup signal is sent to the SIP server first, and then the SIP server would relay it to the target peer after correctly resolving and locating the target peer. During the call setup (signaling) phase, Calling state is displayed in the Status field, and it turns to InCall state once the call is successfully established.</p> <p><b>Incoming Call</b> – It is a SIP VoIP call made or originated by remote SIP accounts to connect to this local SIP account. One or more local phone ports can be configured to receive this type of call, see the Incoming Number below, and all of them should begin to ring during the call setup (signaling phase), see the Status above. Once some remote SIP accounts start to ring one local phone, answer by off-hook to the call, and the call is successfully established. The other ringing local phone ports will stop ringing and turning to InCall state in the Status field.</p> <p><b>Internal Call</b> – It is a local VoIP call between two different local phone ports. No SIP signaling is needed and thus no SIP server is involved to establish this type of call. This type of call is established through the Internal and Non-SIP local setup signaling procedure between the call- originating and call-terminating local phone ports. In general, one or more local phone ports can be designed to receive this type of call, and once any of the ringing phones answer the call, the other ringing ones will stop ringing. During the call setup phase (signaling phase), Calling state is displayed in Status field, and turns to InCall state once the call is successfully established.</p>
Codec	This field displays what voice codec is being used for a current VoIP call through a phone port.
From Phone Port Type	This field displays the phone ports type used to originate, start, or create the current VoIP call. Two possible type values will be displayed here: SIP – For the current call which is categorized as Incoming Call in the Call Type field, this field will show the type SIP. FXS – As for the other cases: Outgoing Call and Internal Call, this field will show the corresponding local phone port type: FXS, the legacy analog phone port on the device.
To Phone Port Type	This field displays the phone ports type used to receive the current VoIP call. Three possible type values will be displayed here: SIP – For the current call which is categorized as Outgoing Call in the Call Type field, this field will show the type SIP. FXS and Unknown – As for the other cases: Incoming Call and Internal Call, this field will show the corresponding local phone port type: FXS, the legacy analog phone port on the device. While the call is established, this field shows Unknown during the call setup phase (signaling phase). This is because one or more local phone ports can be configured or designed to receive these two types of calls, see the Call Type above, and the local phone port will answer the call that hasn't been determined yet at that time.
Peer Number	This field displays the SIP number of the party that is currently engaged in a VoIP call through a phone port.
Phone Status	
Phone	This field displays the name of a phone port on the Device.
Outgoing Number	This field displays the SIP number that you use to make calls on this phone port.
Incoming Number	This field displays the SIP number that you use to receive calls on this phone port.
Hook Status	<p>This field displays whether the phone is in the on or off hook status.</p> <p><b>Off-Hook</b> means a telephone connected to one of the phone port has its receiver off the hook.</p> <p><b>On-Hook</b> means a telephone connected to one of the phone port has its receiver on the hook.</p>

# CHAPTER 29

## ARP Table

### 29.1 ARP Table Overview

Address Resolution Protocol (ARP) is a protocol for mapping an Internet Protocol (IP) address to a physical machine address, known as a Media Access Control (MAC) address, on the local area network.

An IP version 4 address is 32 bits long. MAC addresses are 48 bits long. The ARP table maintains an association between each MAC address and its corresponding IP address.

#### 29.1.1 How ARP Works

When an incoming packet destined for a host device on a local area network arrives at the device, the device's ARP program looks in the ARP table and, if it finds the address, sends it to the device.

If no entry is found for the IP address, ARP broadcasts the request to all the devices on the LAN. The device fills in its own MAC and IP address in the sender address fields, and puts the known IP address of the target in the target IP address field. In addition, the device puts all ones in the target MAC field (FF.FF.FF.FF.FF.FF is the Ethernet broadcast address). The replying device (which is either the IP address of the device being sought or the router that knows the way) replaces the broadcast address with the target's MAC address, swaps the sender and target pairs, and unicasts the answer directly back to the requesting machine. ARP updates the ARP table for future reference and then sends the packet to the MAC address that replied.

### 29.2 ARP Table

Use the ARP table to view the IPv4-to-MAC address mappings for each device connected to the Zyxel Device. The neighbor table shows the IPv6-to-MAC address mappings of each IPv6 neighbor. To open this screen, click **System Monitor > ARP Table**.

Figure 252 System Monitor &gt; ARP Table

### ARP Table

Address Resolution Protocol (ARP) is a protocol for mapping an Internet Protocol address (IP address) to a physical machine address, also known as a Media Access Control or MAC address, on the local area network.

The ARP table maintains an association between each MAC address and its corresponding IP address.

Use the ARP table to view the IPv4-to-MAC address mapping(s) for the LAN. The neighbor table shows the IPv6-to-MAC address mapping(s) of each neighbor.

IPv4 ARP Table

#	IPv4 Address	MAC Address	Device
1	192.168.1.100	08:00:27:00:00:01	br0
2	192.168.1.101	08:00:27:00:00:02	br0

IPv6 Neighbour Table

#	IPv6 Address	MAC Address	Device
1	fe80::200:0:0:0:0:0:0:0	08:00:27:00:00:01	br0
2	fe80::200:0:0:0:0:0:0:0	08:00:27:00:00:02	br0

The following table describes the labels in this screen.

Table 172 System Monitor &gt; ARP Table

LABEL	DESCRIPTION
#	This is the ARP table entry number.
IPv4 / IPv6 Address	This is the learned IPv4 or IPv6 IP address of a device connected to the Zyxel Device.
MAC Address	This is the MAC address of the connected device with the listed IP address.
Device	This is the type of interface used by the connected device. You can click the device type to go to its configuration screen.

# CHAPTER 30

## Routing Table

### 30.1 Routing Table Overview

Routing is based on the destination address only and the Zyxel Device takes the shortest path to forward a packet.

### 30.2 Routing Table

The table below shows IPv4 and IPv6 routing information. The IPv4 subnet mask is '255.255.255.255' for a host destination and '0.0.0.0' for the default route. The gateway address is written as '\*'(IPv4)('/: '(IPv6) if none is set.

Click **System Monitor > Routing Table** to open the following screen.

Figure 253 System Monitor &gt; Routing Table

Routing Table					
Routing is based on the destination address only and the Zyxel Device takes the shortest path to forward a packet.					
The table below shows IPv4 and IPv6 routing information. The IPv4 subnet mask is '255.255.255.255' for a host destination and '0.0.0.0' for the default route. The gateway address is written as '*' (IPv4) / ':' (IPv6) if none is set.					
<b>Destination:</b> This indicates the destination IPv4 address or IPv6 address and prefix of this route.					
<b>Gateway:</b> This indicates the IPv4 address or IPv6 address of the gateway that helps forward this route's traffic.					
<b>Subnet Mask:</b> This indicates the destination subnet mask of the IPv4 route.					
<b>Flag:</b> This indicates the route status.					
U-Up: The route is up.					
I-Reject: The route is blocked and will force a route lookup to fail.					
G-Gateway: The route uses a gateway to forward traffic.					
H-Host: The target of the route is a host.					
R-Reinstate: The route is reinstated for dynamic routing.					
D-Dynamic (redirect): The route is dynamically installed by a routing daemon or redirect.					
M-Modified (redirect): The route is modified from a routing daemon or redirect.					
<b>Metric:</b> The metric represents the "cost of transmission". A router determines the best route for transmission by choosing a path with the lowest "cost". The smaller the number, the lower the "cost".					
<b>Interface:</b> This indicates the name of the interface through which the route is forwarded.					
IPv4 Routing Table					
Destination	Gateway	Subnet Mask	Flag	Metric	Interface
0.0.0.0	0.0.0.0	255.255.0.0	U	0	lo
192.168.1.0/24	0.0.0.0	255.255.255.0	U	0	br0
192.168.1.1	0.0.0.0	255.0.0.0	U	0	br0
IPv6 Routing Table					
Destination	Gateway	Flag	Metric	Interface	
fe80::/64	::	U	256	eth0	
fe80::/64	::	U	256	eth0.1	
fe80::/64	::	U	256	eth0.2	
fe80::/64	::	U	256	eth0.3	
fe80::/64	::	U	256	eth0.4	
fe80::/64	::	U	256	nas10	
fe80::/64	::	U	256	br0	
fe80::/64	::	U	256	ra0	
fe80::/64	::	U	256	ra1	
fe80::/64	::	U	256	ra2	
fe80::/64	::	U	256	ra3	
fe80::/64	::	U	256	rai0	
fe80::/64	::	U	256	rai1	
fe80::/64	::	U	256	rai2	
fe80::/64	::	U	256	rai3	
fe80::/64	::	U	256	rai5	
::1/128	::	U	0	lo	

The following table describes the labels in this screen.

Table 173 System Monitor &gt; Routing Table

LABEL	DESCRIPTION
IPv4 / IPv6 Routing Table	
Destination	This indicates the destination IPv4 address or IPv6 address and prefix of this route.
Gateway	This indicates the IPv4 address or IPv6 address of the gateway that helps forward this route's traffic.
Subnet Mask	This indicates the destination subnet mask of the IPv4 route.



Table 173 System Monitor &gt; Routing Table (continued)

LABEL	DESCRIPTION
Flag	<p>This indicates the route status.</p> <p><b>U-Up:</b> The route is up.</p> <p><b>!-Reject:</b> The route is blocked and will force a route lookup to fail.</p> <p><b>G-Gateway:</b> The route uses a gateway to forward traffic.</p> <p><b>H-Host:</b> The target of the route is a host.</p> <p><b>R-Reinstate:</b> The route is reinstated for dynamic routing.</p> <p><b>D-Dynamic (redirect):</b> The route is dynamically installed by a routing daemon or redirect.</p> <p><b>M-Modified (redirect):</b> The route is modified from a routing daemon or redirect.</p>
Metric	<p>The metric represents the "cost of transmission." A router determines the best route for transmission by choosing a path with the lowest "cost." The smaller the number, the lower the "cost."</p>
Interface	<p>This indicates the name of the interface through which the route is forwarded.</p> <ul style="list-style-type: none"> <li>• <b>brx</b> indicates a LAN interface where x can be 0 – 3 to represent LAN1 to LAN4 respectively.</li> <li>• <b>ptm0</b> indicates a VDSL (including G.fast) WAN interface using IPoE or in bridge mode.</li> <li>• <b>ethx</b> indicates an Ethernet WAN interface using IPoE or in bridge mode.</li> <li>• <b>ppp0</b> indicates a WAN interface using PPPoE.</li> <li>• <b>wlx</b> indicates a wireless interface where x can be 0 – 1.</li> </ul>

# CHAPTER 31

## Multicast Status

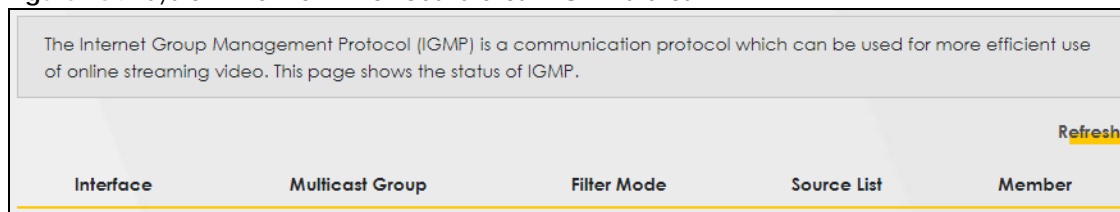
### 31.1 Multicast Status Overview

Use the **Multicast Status** screens to look at IGMP/MLD group status and traffic statistics.

### 31.2 The IGMP Status Screen

Use this screen to look at the current list of multicast groups the Zyxel Device manages through IGMP. Configure IGMP in **Network Setting > IGMP/MLD**. To open this screen, click **System Monitor > Multicast Status > IGMP Status**.

**Figure 254** System Monitor > Multicast Status > IGMP Status



The following table describes the labels in this screen.

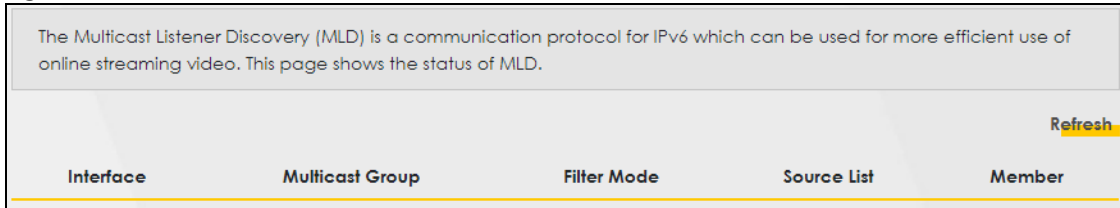
Table 174 System Monitor > Multicast Status > IGMP Status

LABEL	DESCRIPTION
Refresh	Click this button to update the information on this screen.
Interface	This field displays the name of an interface on the Zyxel Device that belongs to an IGMP multicast group.
Multicast Group	This field displays the name of the IGMP multicast group to which the interface belongs.
Filter Mode	<b>INCLUDE</b> means that only the IP addresses in the <b>Source List</b> get to receive the multicast group's traffic. <b>EXCLUDE</b> means that the IP addresses in the <b>Source List</b> are not allowed to receive the multicast group's traffic but other IP addresses can.
Source List	This is the list of IP addresses that are allowed or not allowed to receive the multicast group's traffic depending on the filter mode.
Member	This is the list of the members of the multicast group.

## 31.3 The MLD Status Screen

Use this screen to look at the current list of multicast groups the Zyxel Device manages through MLD. Configure MLD in **Network Setting > IGMP/MLD**. To open this screen, click **System Monitor > Multicast Status > MLD Status**.

**Figure 255** System Monitor > Multicast Status > MLD Status



The following table describes the labels in this screen.

Table 175 System Monitor > Multicast Status > MLD Status

LABEL	DESCRIPTION
Refresh	Click this button to update the status on this screen.
Interface	This field displays the name of an interface on the Zyxel Device that belongs to an MLD multicast group.
Multicast Group	This field displays the name of the MLD multicast group to which the interface belongs.
Filter Mode	<b>INCLUDE</b> means that only the IP addresses in the <b>Source List</b> get to receive the multicast group's traffic. <b>EXCLUDE</b> means that the IP addresses in the <b>Source List</b> are not allowed to receive the multicast group's traffic but other IP addresses can.
Source List	This is the list of IP addresses that are allowed or not allowed to receive the multicast group's traffic depending on the filter mode.
Member	This is the list of members in the multicast group.

# CHAPTER 32

## xDSL Statistics

### 32.1 xDSL Statistics Overview

You can view information about DSL statistics, such as port details, in this screen.

### 32.2 xDSL Statistics

Use this screen to view detailed DSL statistics. Click **System Monitor > xDSL Statistics** to open the following screen.

Note: This screen is only available if your Zyxel Device is a DSL router.

**Figure 256** System Monitor > xDSL Statistics

**xDSL Statistics**

Use this screen to view detailed DSL information. It allows you to see the DSL status, check port details, and see DSL counters.

**Monitor**

Type: Stats

Refresh Interval: No Refresh

Line: Line 0

**Status**

```
=====
=====
xDSL Training Status: Idle
Mode: G.DMT
Traffic Type: Inactive
Link Uptime: N/A
=====
=====
xDSL Port Details  Upstream  Downstream
Line Rate: 0.000 Mbps 0.000 Mbps
Actual Net Data Rate: 0.000 Mbps 0.000 Mbps
Trellis Coding: N/A N/A
SNR Margin: 0.0 dB 0.0 dB
=====
```

The following table describes the labels in this screen.

Table 176 System Monitor &gt; xDSL Statistics

LABEL	DESCRIPTION
Monitor	
Type	Select the type of DSL line for refreshing statistics.
Refresh Interval	Select the time interval for refreshing statistics.
Line	Select which DSL line's statistics you want to display.
Status	
xDSL Training Status	This displays the current state of setting up the DSL connection.
Mode	This displays the ITU standard used for this connection.
Traffic Type	This displays the type of traffic the DSL port is sending and receiving. <b>Inactive</b> displays if the DSL port is not currently sending or receiving traffic.
Link Uptime	This displays how long the port has been running (or connected) since the last time it was started.
xDSL Port Details	
Upstream	These are the statistics for the traffic direction going out from the port to the service provider.
Downstream	These are the statistics for the traffic direction coming into the port from the service provider.
Line Rate	These are the data transfer rates at which the port is sending and receiving data.
Actual Net Data Rate	These are the rates at which the port is sending and receiving the payload data without transport layer protocol headers and traffic.
Trellis Coding	This displays whether or not the port is using Trellis coding for traffic it is sending and receiving. Trellis coding helps to reduce the noise in ADSL transmissions. Trellis may reduce throughput but it makes the connection more stable.
SNR Margin	This is the upstream and downstream Signal-to-Noise Ratio margin (in dB). A DMT sub-carrier's SNR is the ratio between the received signal power and the received noise power. The signal-to-noise ratio margin is the maximum that the received noise power could increase with the system still being able to meet its transmission targets.
Actual Delay	This is the upstream and downstream interleave delay. It is the wait (in milliseconds) that determines the size of a single block of data to be interleaved (assembled) and then transmitted. Interleave delay is used when transmission error correction (Reed- Solomon) is necessary due to a less than ideal telephone line. The bigger the delay, the bigger the data block size, allowing better error correction to be performed.
Transmit Power	This is the upstream and downstream far end actual aggregate transmit power (in dBm). Upstream is how much power the port is using to transmit to the service provider. Downstream is how much power the service provider is using to transmit to the port.
Receive Power	Upstream is how much power the service provider is receiving from the port. Downstream is how much power the port is receiving from the service provider.
Actual INP	Sudden spikes in the line's level of external noise (impulse noise) can cause errors and result in lost packets. This could especially impact the quality of multimedia traffic such as voice or video. Impulse noise protection (INP) provides a buffer to allow for correction of errors caused by error correction to deal with this. The number of DMT (Discrete Multi-Tone) symbols shows the level of impulse noise protection for the upstream and downstream traffic. A higher symbol value provides higher error correction capability, but it causes overhead and higher delay which may increase error rates in received multimedia data.
Attainable Net Data Rate	These are the highest theoretically possible transfer rates at which the port could send and receive payload data without transport layer protocol headers and traffic.
xDSL Counters	
Downstream	These are the statistics for the traffic direction coming into the port from the service provider.
Upstream	These are the statistics for the traffic direction going out from the port to the service provider.

Table 176 System Monitor &gt; xDSL Statistics (continued)

<b>LABEL</b>	<b>DESCRIPTION</b>
FEC	This is the number of Far End Corrected blocks.
CRC	This is the number of Cyclic Redundancy Checks.
ES	This is the number of Errored Seconds meaning the number of seconds containing at least one error block or at least one defect.
SES	This is the number of Severely Errored Seconds meaning the number of seconds containing 30% or more error blocks or at least one defect. This is a subset of ES.
UAS	This is the number of UnAvailable Seconds.
LOS	This is the number of Loss Of Signal seconds.
LOF	This is the number of Loss Of Frame seconds.
LOM	This is the number of Loss Of Margin seconds.
Retr	This is the number of DSL retraining count in BCM DSL driver.
HostInitRetr	This is the number of the retraining counts the host initiated.
FailedRetr	This is the number of failed retraining attempts.

# CHAPTER 33

## WLAN Station Status

### 33.1 WLAN Station Status Overview

Click **System Monitor > WLAN Station Status** to open the following screen. Use this screen to view information and status of the wireless stations (WiFi clients) that are currently associated with the Zyxel Device. Being associated means that a WiFi client (for example, your computer with a WiFi network card installed) has connected successfully to an AP (or WiFi router) using the same SSID, channel, and WiFi security settings.

**Figure 257** System Monitor > WLAN Station Status

**WLAN Station Status**

Use this screen to view information and status of the wireless stations (wireless clients) that are currently associated with the Zyxel Device. Being associated means that a wireless client (for example, your computer with a wireless network card installed) has connected successfully to an AP (or wireless router) using the same SSID, channel, and WiFi security settings.

Refresh Interval:

WLAN 2.4G Station Status

#	MAC Address	Rate (Mbps)	RSSI (dBm)	SNR	Level

WLAN 5G Station Status

#	MAC Address	Rate (Mbps)	RSSI (dBm)	SNR	Level

WLAN 6G Station Status

#	MAC Address	Rate (Mbps)	RSSI (dBm)	SNR	Level

The following table describes the labels in this screen.

**Table 177** System Monitor > WLAN Station Status

LABEL	DESCRIPTION
Refresh Interval	Select how often you want the Zyxel Device to update this screen.
#	This is the index number of an associated wireless station.
MAC Address	This field displays the MAC address of an associated wireless station.
Rate (Mbps)	This field displays the transmission rate of WiFi traffic between an associated wireless station and the Zyxel Device.
RSSI (dBm)	The RSSI (Received Signal Strength Indicator) field shows the WiFi signal strength of the station's wireless connection.  The normal range is -30dBm to -79dBm. If the value drops below -80dBm, try moving the associated wireless station closer to the Zyxel Device to get better signal strength.

Table 177 System Monitor &gt; WLAN Station Status (continued)

LABEL	DESCRIPTION
SNR	<p>The Signal-to-Noise Ratio (SNR) is the ratio between the received signal power and the received noise power. The greater the number, the better the quality of WiFi.</p> <p>The normal range is 15 to 40. If the value drops below 15, try moving the associated wireless station closer to the Zyxel Device to get better quality WiFi.</p>
Level	<p>This field displays a number which represents the strength of the WiFi signal between an associated wireless station and the Zyxel Device. The Zyxel Device uses the RSSI and SNR values to determine the strength of the WiFi signal.</p> <p>5 means the Zyxel Device is receiving an excellent WiFi signal.</p> <p>4 means the Zyxel Device is receiving a very good WiFi signal.</p> <p>3 means the Zyxel Device is receiving a weak WiFi signal,</p> <p>2 means the Zyxel Device is receiving a very weak WiFi signal.</p> <p>1 means the Zyxel Device is not receiving a WiFi signal.</p>



# CHAPTER 34

## Cellular Statistics

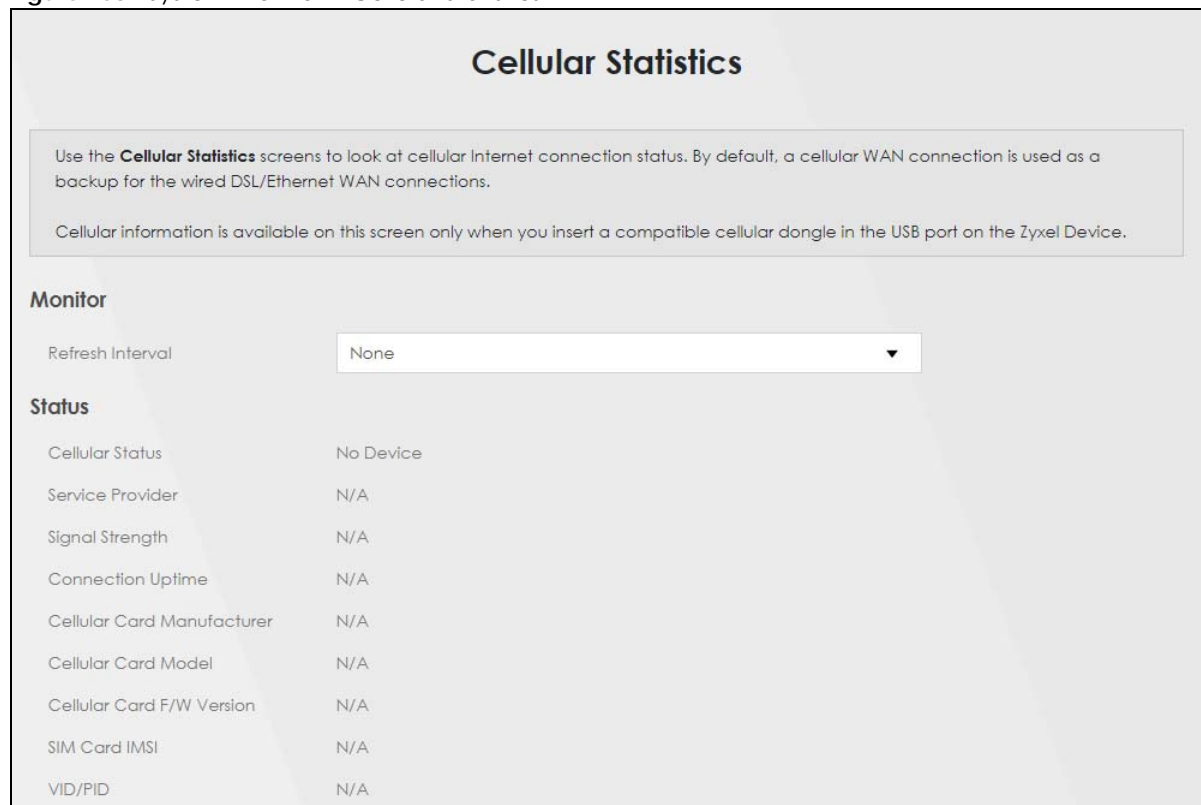
### 34.1 Cellular Statistics Overview

Use the **Cellular Statistics** screens to look at cellular Internet connection status. By default, a cellular WAN connection is used as a backup for the wired DSL or Ethernet WAN connections.

### 34.2 Cellular Statistics Settings

To open this screen, click **System Monitor > Cellular Statistics**. Cellular information is available on this screen only when you insert a compatible cellular dongle in the USB port on the Zyxel Device.

**Figure 258** System Monitor > Cellular Statistics



**Cellular Statistics**

Use the **Cellular Statistics** screens to look at cellular Internet connection status. By default, a cellular WAN connection is used as a backup for the wired DSL/Ethernet WAN connections.

Cellular information is available on this screen only when you insert a compatible cellular dongle in the USB port on the Zyxel Device.

**Monitor**

Refresh Interval:

**Status**

Cellular Status	No Device
Service Provider	N/A
Signal Strength	N/A
Connection Uptime	N/A
Cellular Card Manufacturer	N/A
Cellular Card Model	N/A
Cellular Card F/W Version	N/A
SIM Card IMSI	N/A
VID/PID	N/A

The following table describes the labels in this screen.

Table 178 System Monitor &gt; Cellular Statistics

LABEL	DESCRIPTION
Monitor	
Refresh Interval	Select how often you want the Zyxel Device to update this screen. Select <b>None</b> to stop refreshing.
Status	
Cellular Status	This field displays the status of the cellular Internet connection. This field can display: <b>GSM</b> – Global System for Mobile Communications, 2G <b>GPRS</b> – General Packet Radio Service, 2.5G <b>EDGE</b> – Enhanced Data rates for GSM Evolution, 2.75G <b>WCDMA</b> – Wideband Code Division Multiple Access, 3G <b>HSDPA</b> – High-Speed Downlink Packet Access, 3.5G <b>HSUPA</b> – High-Speed Uplink Packet Access, 3.75G <b>HSPA</b> – HSDPA+HSUPA, 3.75G
Service Provider	This field displays the name of the service provider.
Signal Strength	This field displays the strength of the signal in dBm.
Connection Uptime	This field displays the time the connection has been up.
Cellular Card Manufacturer	This field displays the manufacturer of the cellular card.
Cellular Card Model	This field displays the model name of the cellular card.
Cellular Card F/W Version	This field displays the firmware version of the cellular card.
SIM Card IMSI	The International Mobile Subscriber Identity or IMSI is a unique identification number associated with all cellular networks. This number is provisioned in the SIM card.
VID/PID	This field displays the USB Vendor ID and Product ID of the cellular card.

# CHAPTER 35

## System

### 35.1 System Overview

Use this screen to name your Zyxel Device (Host) and give it an associated domain name for identification purposes.

### 35.2 System

Click **Maintenance > System** to open the following screen. Assign a unique name to the Zyxel Device so it can be easily recognized on your network. You can use up to 30 printable characters except [ " ], [ ` ], [ ' ], [ < ], [ > ], [ ^ ], [ \$ ], [ | ], [ & ], or [ ; ]. Spaces are allowed.

**Figure 259** Maintenance > System

**System**

Use this screen to name your Zyxel Device (Host) and give it an associated domain name for identification purposes.

Assign a unique name to the Zyxel Device so it can be easily recognized on your network. You can use up to 30 characters, including spaces.

Host Name

Domain Name

**Cancel** **Apply**

The following table describes the labels in this screen.

**Table 179** Maintenance > System

LABEL	DESCRIPTION
Host Name	Enter a descriptive host name for your Zyxel Device. You can use up to 30 printable characters except [ " ], [ ` ], [ ' ], [ < ], [ > ], [ ^ ], [ \$ ], [   ], [ & ], or [ ; ]. Spaces are allowed. For some models, the supported maximum input length is 16 alphanumeric characters.
Domain Name	Enter a domain name for your host Zyxel Device. You can use up to 30 printable characters except [ " ], [ ` ], [ ' ], [ < ], [ > ], [ ^ ], [ \$ ], [   ], [ & ], or [ ; ]. Spaces are allowed.
Cancel	Click <b>Cancel</b> to abandon this screen without saving.
Apply	Click <b>Apply</b> to save your changes.

# CHAPTER 36

## User Account

### 36.1 User Account Overview

In the **User Account** screen, you can view the settings of the “admin” and other user accounts that you use to log into the Zyxel Device to manage it.

### 36.2 User Account

Click **Maintenance > User Account** to open the following screen. Use this screen to create or manage user accounts and their privileges on the Zyxel Device.

**Figure 260** Maintenance > User Account

#	Active	User Name	Retry Times	Idle Timeout	Lock Period	Group	Remote Privilege	Modify
1	<input checked="" type="checkbox"/>	admin	3	5	5	Administrator	LAN,WAN	

The following table describes the labels in this screen.

**Table 180** Maintenance > User Account

LABEL	DESCRIPTION
Add New Account	Click this button to add a new user account (up to four <b>Administrator</b> accounts and four <b>User</b> accounts).
#	This is the index number.
Active	This indicates whether the user account is active or not. The check box is selected when the user account is enabled. It is cleared when it is disabled.
User Name	This displays the name of the account used to log into the Zyxel Device Web Configurator.
Retry Times	This displays the number of times consecutive wrong passwords can be entered for this account. 0 means there is no limit.
Idle Timeout	This displays the length of inactive time before the Zyxel Device will automatically log the user out of the Web Configurator.
Lock Period	This field displays the length of time a user must wait before attempting to log in again after a number of consecutive wrong passwords have been entered as defined in <b>Retry Times</b> .

Table 180 Maintenance &gt; User Account (continued)

LABEL	DESCRIPTION
Group	This field displays whether this user has <b>Administrator</b> or <b>User</b> privileges.
Remote Privilege	This field displays whether this user can access the Zyxel Device with HTTP, Telnet or SSH through the <b>WAN</b> , <b>LAN</b> or <b>LAN/WAN</b> .
Modify	Click the <b>Edit</b> icon to configure the entry. Click the <b>Delete</b> icon to remove the entry.
Cancel	Click <b>Cancel</b> to restore your previously saved settings.
Apply	Click <b>Apply</b> to save your changes.

### 36.2.1 User Account Add or Edit

Add or change the name of the user account, set the security password and the retry times, and whether this user will have **Administrator** or **User** privileges. Click **Add New Account** or the **Edit** icon of an existing account in the **Maintenance > User Account** to open the following screen.

Figure 261 Maintenance &gt; User Account: Add

The screenshot shows the 'User Account Add' configuration screen. It includes the following fields and options:

- Active:** A toggle switch that is currently turned on (blue).
- User Name:** A text input field.
- Password:** A password input field with an eye icon to toggle visibility.
- Verify Password:** A password input field with an eye icon to toggle visibility.
- Retry Times:** A text input field containing the value '3', with a range of '(0-5), 0: Not limit'.
- Idle Timeout:** A text input field containing the value '5', with a range of 'Minute(s)(1~60)'. The unit 'Minute(s)' is shown in smaller text.
- Lock Period:** A text input field containing the value '5', with a range of 'Minute(s)(5~90)'. The unit 'Minute(s)' is shown in smaller text.
- Group:** A dropdown menu currently set to 'Administrator'.
- Remote Privilege:** Radio buttons for 'LAN', 'WAN', and 'LAN/WAN'. The 'LAN/WAN' option is selected.

At the bottom of the screen, there are two buttons: 'Cancel' and 'OK'.

Figure 262 Maintenance &gt; User Account: Edit

The following table describes the labels in this screen.

Table 181 Maintenance &gt; User Account &gt; User Account Add/Edit

LABEL	DESCRIPTION
Active	Click to enable (switch turns blue) or disable (switch turns gray) to activate or deactivate the user account.
User Name	Enter a name for this account. You can use up to 31 printable characters except [ " ], [ ` ], [ ' ], [ < ], [ > ], [ ^ ], [ \$ ], [   ], [ & ], or [ ; ]. Spaces are allowed.
Password	Enter your new system password. The password must contain at least one numeric and one alphabetic character. You can use 6 – 64 alphanumeric (0-9, a-z, A-Z) and special characters except [ " ], [ ` ], [ ' ], [ < ], [ > ], [ ^ ], [ \$ ], [   ], [ & ], or [ ; ]. Spaces are allowed.  Note that as you type a password, the screen displays a (*) for each character you type. After you change the password, use the new password to access the Zyxel Device.  If you are changing your existing password, you have to first enter your <b>Old Password</b> then enter your <b>New Password</b> .
Verify Password	Enter the new password again for confirmation.
Retry Times	Enter the number of times consecutive wrong passwords can be entered for this account. 0 means there is no limit.
Idle Timeout	Enter the length of inactive time before the Zyxel Device will automatically log the user out of the Web Configurator.
Lock Period	Enter the length of time a user must wait before attempting to log in again after a number of consecutive wrong passwords have been entered as defined in <b>Retry Times</b> .

Table 181 Maintenance &gt; User Account &gt; User Account Add/Edit (continued)

LABEL	DESCRIPTION
Group	<p>Specify whether this user will have <b>Administrator</b> or <b>User</b> privileges. An <b>Administrator</b> account can access all Web Configurator menus. A <b>User</b> account can only access <b>Monitor</b> and <b>Maintenance</b> menus.</p> <p>The maximum account number of <b>Administrator</b> and <b>User</b> are both four. The total number of the users allowed to log in the Zyxel Device at the same time is eight.</p> <p><b>The Administrator</b> privileges are the following:</p> <ul style="list-style-type: none"> <li>• <b>Quick Start</b> setup.</li> <li>• The following screens are visible for setup: <b>Broadband, Wireless, Home Networking, Routing, NAT, DNS, Firewall, MAC Filter, Voice, Log, Traffic Status, ARP Table, Routing Table, Cellular WAN Status, System, User Account, Remote Management, Time, Email Notification, Log Setting, Firmware Upgrade, Backup/Restore, Reboot, Diagnostic.</b></li> </ul> <p><b>The User</b> privileges are the following:</p> <ul style="list-style-type: none"> <li>• The following screens are visible for setup: <b>Log, Traffic Status, ARP Table, Routing Table, Cellular WAN Status, User Account, Remote Management, Time, Email Notification, Log Setting, Firmware Upgrade, Backup/Restore, Reboot, Diagnostic.</b></li> </ul>
Remote Privilege	<p>Select whether this user can access the Zyxel Device with HTTP, Telnet or SSH through the <b>WAN, LAN</b> or <b>LAN/WAN</b>. Only the <b>Administrator</b> is allowed to use Telnet and SSH for remote management.</p>
Cancel	<p>Click <b>Cancel</b> to restore your previously saved settings.</p>
OK	<p>Click <b>OK</b> to save your changes.</p>

# CHAPTER 37

## Remote Management

### 37.1 Remote Management Overview

Remote management controls through which interfaces, which web services (such as HTTP, HTTPS, FTP, Telnet, SSH and Ping) can access the Zyxel Device.

Note: The Zyxel Device is managed using the Web Configurator.

#### 37.1.1 What You Can Do in this Chapter

- Use the **MGMT Services** screen to allow various approaches to access the Zyxel Device remotely from a WAN and/or LAN connection ([Section 37.2 on page 472](#)).
- Use the **Trust Domain** screen to enable users to permit access from local management services by entering specific IP addresses ([Section 37.3 on page 473](#)).

### 37.2 MGMT Services

Use this screen to configure the interfaces through which services can access the Zyxel Device. You can also specify service port numbers computers must use to connect to the Zyxel Device. Click **Maintenance > Remote Management > MGMT Services** to open the following screen.

**Figure 263** Maintenance > Remote Management > MGMT Services

**MGMT Services** Trust Domain

Use this screen to configure the interfaces through which services can access the Zyxel Device. You can also specify service port numbers computers must use to connect to the Zyxel Device.

**Service Control**

WAN Interface used for services  Any\_WAN  Multi\_WAN

ADSL  VDSL  ETHWAN

Service	LAN	WAN	Trust Domain	Port	Redirect ⓘ
HTTP	<input checked="" type="checkbox"/> Enable	<input checked="" type="checkbox"/> Enable	<input type="checkbox"/> Enable	80	<input checked="" type="checkbox"/> Enable
HTTPS	<input checked="" type="checkbox"/> Enable	<input checked="" type="checkbox"/> Enable	<input type="checkbox"/> Enable	443	
SSH	<input checked="" type="checkbox"/> Enable	<input checked="" type="checkbox"/> Enable	<input type="checkbox"/> Enable	22	
SNMP	<input checked="" type="checkbox"/> Enable	<input checked="" type="checkbox"/> Enable	<input type="checkbox"/> Enable	161	
PING	<input checked="" type="checkbox"/> Enable	<input checked="" type="checkbox"/> Enable	<input type="checkbox"/> Enable		

Cancel Apply



The following table describes the fields in this screen.

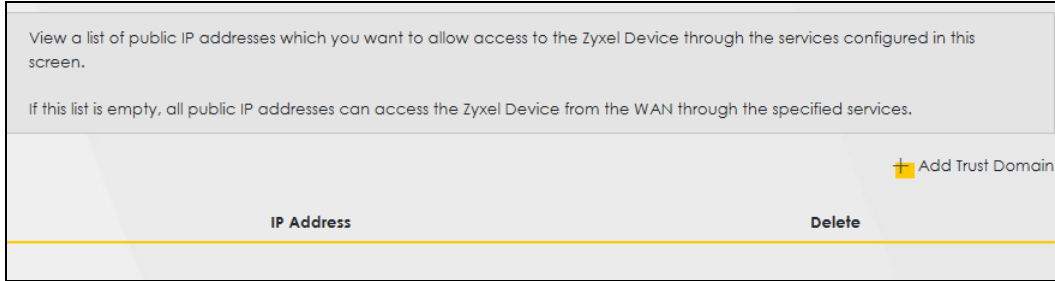
Table 182 Maintenance > Remote Management > MGMT Services

LABEL	DESCRIPTION
Service Control	
WAN Interface used for services	Select <b>Any_WAN</b> to have the Zyxel Device automatically activate the remote management service when any WAN connection is up.  Select <b>Multi_WAN</b> and then select one or more WAN connections to have the Zyxel Device activate the remote management service when the selected WAN connections are up.
WWAN	Enable the WWAN (cellular) connection configured in <b>Network Setting &gt; Broadband &gt; Cellular Backup</b> to access the service on the Zyxel Device.
ETHWAN	Enable the Ethernet WAN connection configured in <b>Network Setting &gt; Broadband &gt; Ethernet WAN</b> to access the service on the Zyxel Device.
ADSL	Enable the ADSL connection configured in <b>Network Setting &gt; Broadband &gt; Add New WAN Interface</b> or <b>Modify</b> to access the service on the Zyxel Device.
VDSL	Enable the VDSL WAN connection configured in <b>Network Setting &gt; Broadband &gt; Add New WAN Interface</b> or <b>Modify</b> to access the service on the Zyxel Device.
Service	This is the service you may use to access the Zyxel Device.
LAN	Select the <b>Enable</b> check box for the corresponding services that you want to allow access to the Zyxel Device from the LAN.
WLAN	Select the <b>Enable</b> check box for the corresponding services that you want to allow access to the Zyxel Device from the WLAN.
WAN	Select the <b>Enable</b> check box for the corresponding services that you want to allow access to the Zyxel Device from all WAN connections.
Trust Domain	Select the <b>Enable</b> check box for the corresponding services that you want to allow access to the Zyxel Device from the trusted host IP address.
Port	You may change the server port number for a service if needed, however you must use the same port number in order to use that service for remote management.
Redirect HTTP to HTTPS	To allow only secure Web Configurator access, select this to redirect all HTTP connection requests to the HTTPS server. For example, if you enter http://192.168.1.1 in your browser to access the web configurator, then the Zyxel Device will automatically change this to the more secure https://192.168.1.1 for access.
Apply	Click <b>Apply</b> to save your changes back to the Zyxel Device.
Cancel	Click <b>Cancel</b> to restore your previously saved settings.

## 37.3 Trust Domain

Use this screen to view a list of public IP addresses which are allowed to access the Zyxel Device through the services configured in the **Maintenance > Remote Management > MGMT Services** screen. Click **Maintenance > Remote Management > Trust Domain** to open the following screen.

Note: Enter the IP address of the management station permitted to access the local management services. If specific services from the trusted hosts are allowed access but the trust domain list is empty, all public IP addresses can access the Zyxel Device from the WAN using the specified services.

**Figure 264** Maintenance > Remote Management > Trust Domain

The following table describes the fields in this screen.

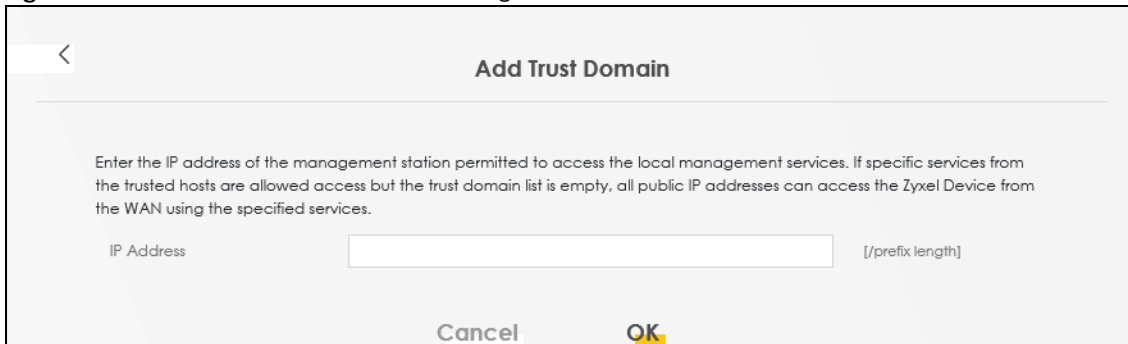
**Table 183** Maintenance > Remote Management > Trust Domain

LABEL	DESCRIPTION
Add Trust Domain	Click this to add a trusted host IP address.
IP Address	This field shows a trusted host IP address.
Delete	Click the <b>Delete</b> icon to remove the trusted host IP address.

### 37.3.1 Add Trust Domain

Use this screen to add a public IP addresses or a complete domain name of a device which is allowed to access the Zyxel Device. Enter the IP address of the management station permitted to access the local management services. If specific services from the trusted-hosts are allowed access but the trust domain list is empty, all public IP addresses can access the Zyxel Device from the WAN using the specified services.

Click the **Add Trust Domain** button in the **Maintenance > Remote Management > Trust Domain** screen to open the following screen.

**Figure 265** Maintenance > Remote Management > Trust Domain > Add Trust Domain

The following table describes the fields in this screen.

**Table 184** Maintenance > Remote Management > Trust Domain > Add Trust Domain

LABEL	DESCRIPTION
IP Address	Enter a public IPv4/IPv6 IP address which is allowed to access the service on the Zyxel Device from the WAN.
OK	Click <b>OK</b> to save your changes back to the Zyxel Device.
Cancel	Click <b>Cancel</b> to restore your previously saved settings.



# CHAPTER 38

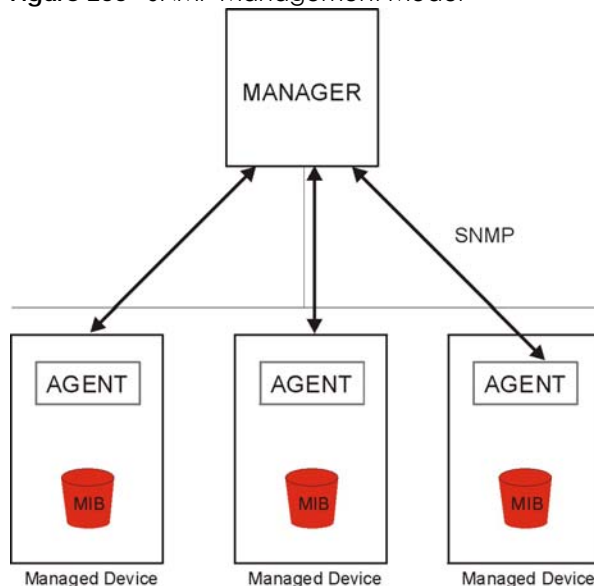
# SNMP

## 38.1 SNMP Overview

This chapter explains how to configure the SNMP settings on the Zyxel Device.

Simple Network Management Protocol is a protocol used for exchanging management information between network devices. Your Zyxel Device supports SNMP agent functionality, which allows a manager station to manage and monitor the Zyxel Device through the network. The Zyxel Device supports SNMP version one (SNMPv1) and version two (SNMPv2c). The next figure illustrates an SNMP management operation.

**Figure 266** SNMP Management Model



An SNMP managed network consists of two main types of component: agents and a manager.

An agent is a management software module that resides in a managed device (the Zyxel Device). An agent translates the local management information from the managed device into a form compatible with SNMP. The manager is the console through which network administrators perform network management functions. It executes applications that control and monitor managed devices.

The managed devices contain object variables or managed objects that define each piece of information to be collected about a device. Examples of variables include such as number of packets received, node port status, and so on. A Management Information Base (MIB) is a collection of managed objects. SNMP allows a manager and agents to communicate for the purpose of accessing these objects.

SNMP itself is a simple request/response protocol based on the manager or agent model. The manager issues a request and the agent returns responses using the following protocol operations:

- Get – Allows the manager to retrieve an object variable from the agent.
- GetNext – Allows the manager to retrieve the next object variable from a table or list within an agent. In SNMPv1, when a manager wants to retrieve all elements of a table from an agent, it initiates a Get operation, followed by a series of GetNext operations.
- Set – Allows the manager to set values for object variables within an agent.
- Trap – Used by the agent to inform the manager of some events.

## 38.2 SNMP Settings

Click **Maintenance > SNMP** to open the following screen. Use this screen to configure the Zyxel Device SNMP settings.

**Figure 267** Maintenance > SNMP

**SNMP**

This screen allows you to configure the SNMP settings on the Zyxel Device.

The Simple Network Management Protocol is a protocol used for exchanging management information between network devices. Your Zyxel Device supports SNMP agent functionality, which allows a manager station to manage and monitor the Zyxel Device through the network.

Configure how the Zyxel Device reports to the Network Management System (NMS) via SNMP using the screen below.

SNMP Agent

Get Community

Set Community

Trap Community

System Name

System Location

System Contact

Trap Destination

The following table describes the fields in this screen.

**Table 185** Maintenance > SNMP

LABEL	DESCRIPTION
SNMP Agent	Click the switch (turns blue) to let the Zyxel Device act as an SNMP agent, which allows a manager station to manage and monitor the Zyxel Device through the network. Otherwise, click the switch (turns gray) to turn this feature off.
Get Community	Enter the <b>Get Community</b> , which is the password for the incoming Get and GetNext requests from the management station.
Set Community	Enter the <b>Set community</b> , which is the password for incoming Set requests from the management station.
Trap Community	Enter the <b>Trap Community</b> , which is the password sent with each trap to the SNMP manager. The default is public and allows all requests.
System Name	Enter the SNMP system name.
System Location	Enter the SNMP system location.

Table 185 Maintenance &gt; SNMP (continued)

LABEL	DESCRIPTION
System Contact	Enter the SNMP system contact.
Trap Destination	Type the IP address of the station to send your SNMP traps to.
Apply	Click this to save your changes back to the Zyxel Device.
Cancel	Click this to restore your previously saved settings.

# CHAPTER 39

## Time Settings

### 39.1 Time Settings Overview

This chapter shows you how to configure system related settings, such as system date and time.

### 39.2 Time

For effective scheduling and logging, the Zyxel Device system time must be accurate. Use this screen to configure the Zyxel Device's time based on your local time zone. You can enter a time server address, select the time zone where the Zyxel Device is physically located, and configure Daylight Savings settings if needed.

To change your Zyxel Device's time and date, click **Maintenance** > **Time**. The screen appears as shown.

Figure 268 Maintenance &gt; Time

Configure the Zyxel Device's time based on your local time zone. You can add a time server address, select your time zone, and configure Daylight Savings if your location uses it.

**Current Date/Time**

Current Time 14:21:53  
Current Date 2019-02-27

**Time and Date Setup**

Time Protocol SNTP (RFC-1769)

First Time Server Address pool.ntp.org  
Second Time Server Address clock.nyc.he.net  
Third Time Server Address clock.sjc.he.net  
Fourth Time Server Address None  
Fifth Time Server Address None

**Time Zone**

Time Zone (GMT+08:00) Taipei

**Daylight Savings**

Active

**Start Rule**

Day  1 in  
 Last Sunday in

Month March  
Hour 2 0

**End Rule**

Day  1 in  
 Last Sunday in

Month October  
Hour 3 0

Cancel Apply

The following table describes the fields in this screen.

Table 186 Maintenance &gt; Time

LABEL	DESCRIPTION
Current Date/Time	
Current Time	This displays the time of your Zyxel Device. Each time you reload this screen, the Zyxel Device synchronizes the time with the time server.
Current Date	This displays the date of your Zyxel Device. Each time you reload this screen, the Zyxel Device synchronizes the date with the time server.
Time and Date Setup	
Time Protocol	This displays the time protocol used by your Zyxel Device.



Table 186 Maintenance &gt; Time (continued)

LABEL	DESCRIPTION
First – Fifth Time Server Address	<p>Select an NTP time server from the drop-down list box.</p> <p>Otherwise, select <b>Other</b> and enter the IP address or URL (up to 29 printable characters in length) of your time server.</p> <p>Select <b>None</b> if you do not want to configure the time server.</p> <p>Check with your ISP/network administrator if you are unsure of this information.</p>
Time Zone	
Time zone	Choose the time zone of your location. This will set the time difference between your time zone and Greenwich Mean Time (GMT).
<p>Daylight Savings</p> <p>Daylight Saving Time is a period from late spring to early fall when many countries set their clocks ahead of normal local time by one hour to give more daytime light in the evening.</p>	
Active	Click this switch to enable or disable Daylight Saving Time. When the switch turns blue, the function is enabled. Otherwise, it is not.
Start Rule	<p>Configure the day and time when Daylight Saving Time starts if you enabled Daylight Saving. You can select a specific date in a particular month or a specific day of a specific week in a particular month. The <b>Time</b> field uses the 24 hour format. Here are a couple of examples:</p> <p>Daylight Saving Time starts in most parts of the United States on the second Sunday of March. Each time zone in the United States starts using Daylight Saving Time at 2 A.M. local time. So in the United States, set the day to <b>Second, Sunday</b>, the month to <b>March</b> and the time to <b>2</b> in the <b>Hour</b> field.</p> <p>Daylight Saving Time starts in the European Union on the last Sunday of March. All of the time zones in the European Union start using Daylight Saving Time at the same moment (1 A.M. GMT or UTC). So in the European Union you would set the day to <b>Last, Sunday</b> and the month to <b>March</b>. The time you select in the <b>o'clock</b> field depends on your time zone. In Germany for instance, you would select <b>2</b> in the <b>Hour</b> field because Germany's time zone is one hour ahead of GMT or UTC (GMT+1).</p>
End Rule	<p>Configure the day and time when Daylight Saving Time ends if you enabled Daylight Saving. You can select a specific date in a particular month or a specific day of a specific week in a particular month. The <b>Time</b> field uses the 24 hour format. Here are a couple of examples:</p> <p>Daylight Saving Time ends in the United States on the first Sunday of November. Each time zone in the United States stops using Daylight Saving Time at 2 A.M. local time. So in the United States you would set the day to <b>First, Sunday</b>, the month to <b>November</b> and the time to <b>2</b> in the <b>Hour</b> field.</p> <p>Daylight Saving Time ends in the European Union on the last Sunday of October. All of the time zones in the European Union stop using Daylight Saving Time at the same moment (1 A.M. GMT or UTC). So in the European Union you would set the day to <b>Last, Sunday</b>, and the month to <b>October</b>. The time you select in the <b>o'clock</b> field depends on your time zone. In Germany for instance, you would select <b>2</b> in the <b>Hour</b> field because Germany's time zone is one hour ahead of GMT or UTC (GMT+1).</p>
Cancel	Click <b>Cancel</b> to exit this screen without saving.
Apply	Click <b>Apply</b> to save your changes.

# CHAPTER 40

## Email Notification

### 40.1 Email Notification Overview

A mail server is an application or a computer that can receive, forward and deliver email messages.

To have the Zyxel Device send reports, logs or notifications through email, you must specify an email server and the email addresses of the sender and receiver.

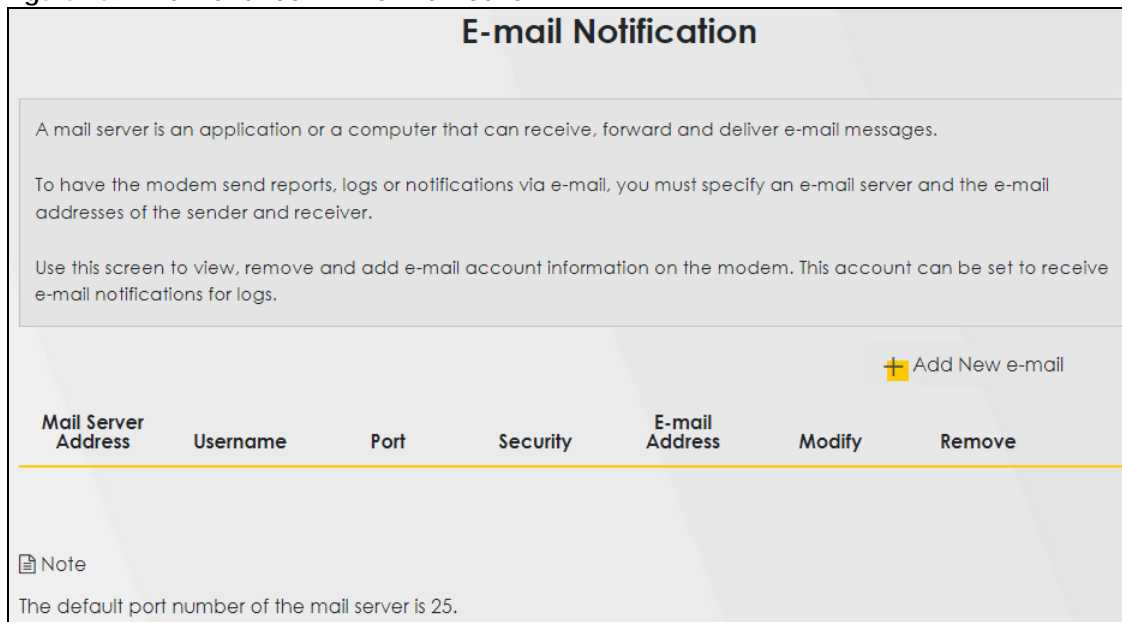
### 40.2 Email Notification

Use this screen to view, remove and add email account information on the Zyxel Device. This account can be set to send email notifications for logs.

Click **Maintenance > E-mail Notification** to open the **E-mail Notification** screen.

Note: The default port number of the mail server is 25.

**Figure 269** Maintenance > E-mail Notification




**E-mail Notification**


A mail server is an application or a computer that can receive, forward and deliver e-mail messages.

To have the modem send reports, logs or notifications via e-mail, you must specify an e-mail server and the e-mail addresses of the sender and receiver.

Use this screen to view, remove and add e-mail account information on the modem. This account can be set to receive e-mail notifications for logs.

 Add New e-mail

Mail Server Address	Username	Port	Security	E-mail Address	Modify	Remove
---------------------	----------	------	----------	----------------	--------	--------

 Note  
The default port number of the mail server is 25.

The following table describes the labels in this screen.

Table 187 Maintenance &gt; E-mail Notification

LABEL	DESCRIPTION
Add New e-mail	Click this button to create a new entry (up to 32 can be created).
Mail Server Address	This displays the server name or the IP address of the mail server.
Username	This displays the user name of the sender's mail account.
Port	This field displays the port number of the mail server.
Security	This field displays the protocol used for encryption.
E-mail Address	This field displays the email address that you want to be in the from or sender line of the email that the Zyxel Device sends.
Modify	Click the <b>Edit</b> icon to configure the entry. Click the <b>Delete</b> icon to remove the entry.
Remove	Click this button to delete the selected entries.

## 40.2.1 E-mail Notification Edit

Click the **Add** button in the **E-mail Notification** screen. Use this screen to configure the required information for sending email through a mail server.

Figure 270 Maintenance &gt; E-mail Notification &gt; Add

The following table describes the labels in this screen.

Table 188 Maintenance &gt; E-mail Notification &gt; Add

LABEL	DESCRIPTION
Mail Server Address	Enter the server name or the IP address of the mail server for the email address specified in the <b>Account e-mail Address</b> field.  If this field is left blank, reports, logs or notifications will not be sent through email.
Port	Enter the same port number here as is on the mail server for mail traffic.
Authentication Username	Enter the user name. You can use up to 32 printable characters except [ " ], [ ` ], [ ' ], [ < ], [ > ], [ ^ ], [ \$ ], [   ], [ & ], or [ ; ]. Spaces are allowed. This is usually the user name of a mail account you specified in the <b>Account email Address</b> field.

Table 188 Maintenance &gt; E-mail Notification &gt; Add (continued)

LABEL	DESCRIPTION
Authentication Password	Enter the password associated with the user name above.
Account e-mail Address	Enter the email address that you want to be in the from or sender line of the email notification that the Zyxel Device sends.  If you activate SSL/TLS authentication, the email address must be able to be authenticated by the mail server as well.
Connection Security	Select <b>SSL</b> to use Secure Sockets Layer (SSL) or Transport Layer Security (TLS) if you want encrypted communications between the mail server and the Zyxel Device.  Select <b>STARTTLS</b> to upgrade a plain text connection to a secure connection using SSL/TLS.
Cancel	Click this button to begin configuring this screen afresh.
OK	Click this button to save your changes and return to the previous screen.

# CHAPTER 41

## Log Setting

### 41.1 Log Setting Overview

You can configure where the Zyxel Device sends logs and which type of logs the Zyxel Device records in the **Logs Setting** screen.

### 41.2 Log Setting

Use this screen to configure where the Zyxel Device sends logs, and which type of logs the Zyxel Device records.

If you have a server that is running a syslog service, you can also save log files to it by enabling **Syslog Logging**, and then entering the IP address of the server in the **Syslog Server** field. Select **Remote** to store logs on the syslog server, or select **Local File** to store logs on the Zyxel Device. Select **Local File and Remote** to store logs on both the Zyxel Device and the syslog server. To change your Zyxel Device's log settings, click **Maintenance > Log Setting**. The screen appears as shown.

Figure 271 Maintenance > Log Setting

### Log Setting

Use this screen to configure where the Zyxel Device sends logs, and which type of logs the Zyxel Device records.

If you have a server that is running a syslog service, you can also save log files to it by enabling **Syslog Logging** and then entering the IP address of the server in the **Syslog Server** field. Select **Remote** to store logs on the syslog server, or select **Local File** to store logs on the Zyxel Device. Select **Local File and Remote** to store logs on both the Zyxel Device and on the syslog server.

---

#### Syslog Setting

Syslog Logging

Mode: Local File and Remote

Syslog Server: 0.0.0.0 (Server NAME or IPv4/IPv6 Address)

UDP Port: 514 (Server Port)

#### E-mail Log Settings

E-mail Log Settings

Mail Account: Select one account

System Log Mail Subject:

Security Log Mail Subject:

Send Log to:  (E-Mail Address)

Send Alarm to:  (E-Mail Address)

Alarm Interval: 60 (seconds)

#### Active Log

##### System Log

- WAN-DHCP
- DHCP Server
- PPPoE
- TR-069
- HTTP
- UPNP
- System
- xDSL
- ACL
- Wireless
- MESH
- IGMP
- Voice

##### Security Log

- Account
- Attack
- Firewall
- MAC Filter

Cancel Apply

The following table describes the fields in this screen.

Table 189 Maintenance &gt; Log Setting

LABEL	DESCRIPTION
Syslog Settings	
Syslog Logging	Slide the switch to the right to enable syslog logging.
Mode	<p>Select <b>Remote</b> to have the Zyxel Device send it to an external syslog server.</p> <p>Select <b>Local File</b> to have the Zyxel Device save the log file on the Zyxel Device itself.</p> <p>Select <b>Local File and Remote</b> to have the Zyxel Device save the log file on the Zyxel Device itself and send it to an external syslog server.</p> <p>Note: A warning appears upon selecting <b>Remote</b> or <b>Local File and Remote</b>. Just click <b>OK</b> to continue.</p>
Syslog Server	Enter the server name or IP address of the syslog server that will log the selected categories of logs.
UDP Port	Enter the port number used by the syslog server.
Enable Syslog over TLS	<p>Use <b>Syslog over TLS</b> to securely send logs from the Zyxel Device to the syslog server using TLS encryption.</p> <p>On the Zyxel Device, first generate a certificate for syslog authentication of the Zyxel Device. The CN (Certificate Name) must match the IP address of the Zyxel Device's interface to the syslog server. Go to <b>Certificates &gt; Local CA</b> and import a certificate for syslog authentication. This is required.</p>
Local Certificate Used by Syslog Client	Optionally, the Syslog server may also request a certificate from the Zyxel Device for mutual authentication. Go to <b>Certificates &gt; Local Certificate</b> and import a Zyxel Device certificate that the syslog server can use to verify the Zyxel Device.
E-mail Log Settings	
E-mail Log Settings	<p>Slide the switch to the right to allow the sending through email the system and security logs to the email address specified in <b>Send Log to</b>.</p> <p>Note: Make sure that the <b>Mail Server Address</b> field is not left blank in the <b>Maintenance &gt; E-mail Notifications</b> screen.</p>
Mail Account	Select a server specified in <b>Maintenance &gt; E-mail Notifications</b> to send the logs to.
System Log Mail Subject	This field allows you to enter a descriptive name for the system log email (for example Zyxel System Log). Up to 127 printable characters are allowed for the <b>System Log Mail Subject</b> including special characters inside the square brackets [!#%()*+,-./:;=?@[\{}~].
Security Log Mail Subject	This field allows you to enter a descriptive name for the security log email (for example Zyxel Security Log). Up to 127 printable characters are allowed for the <b>Security Log Mail Subject</b> including special characters inside the square brackets [!#%()*+,-./:;=?@[\{}~].
Send Log to	This field allows you to enter the log's designated email recipient. The log's format is plain text file sent as an email attachment.
Send Alarm to	This field allows you to enter the alarm's designated e-mail recipient. The alarm's format is plain text file sent as an email attachment.
Alarm Interval	Select the frequency of showing of the alarm.
Active Log	
System Log	Select the categories of <b>System Logs</b> that you want to record.
Security Log	Select the categories of <b>Security Logs</b> that you want to record.
Apply	Click <b>Apply</b> to save your changes.
Cancel	Click <b>Cancel</b> to restore your previously saved settings.

## 41.2.1 Example Email Log

An 'End of Log' message displays for each mail in which a complete log has been sent. The following is an example of a log sent by email.

- You may edit the subject title.
- The date format here is Day-Month-Year.
- The date format here is Month-Day-Year. The time format is Hour-Minute-Second.
- 'End of Log' message shows that a complete log has been sent.

**Figure 272** Email Log Example

```

Subject:
    Firewall Alert From
Date:
    Fri, 07 Apr 2000 10:05:42
From:
    user@zyxel.com
To:
    user@zyxel.com
1|Apr 7 00 |From:192.168.1.1      To:192.168.1.255  |default policy  |forward
  |09:54:03 |UDP      src port:00520 dest port:00520  |<1,00>         |
2|Apr 7 00  |From:192.168.1.131   To:192.168.1.255  |default policy  |forward
  |09:54:17  |UDP      src port:00520 dest port:00520  |<1,00>         |
3|Apr 7 00  |From:192.168.1.6     To:10.10.10.10    |match           |forward
  |09:54:19  |UDP      src port:03516 dest port:00053  |<1,01>         |
.....{snip}.....
.....{snip}.....
126|Apr 7 00  |From:192.168.1.1     To:192.168.1.255  |match           |forward
   |10:05:00  |UDP      src port:00520 dest port:00520  |<1,02>         |
127|Apr 7 00  |From:192.168.1.131   To:192.168.1.255  |match           |forward
   |10:05:17  |UDP      src port:00520 dest port:00520  |<1,02>         |
128|Apr 7 00  |From:192.168.1.1     To:192.168.1.255  |match           |forward
   |10:05:30  |UDP      src port:00520 dest port:00520  |<1,02>         |

End of Firewall Log

```



# CHAPTER 42

## Firmware Upgrade

### 42.1 Firmware Upgrade Overview

This chapter explains how to upload new firmware to your Zyxel Device **if you get** new firmware releases from **your service provider**.

### 42.2 Firmware Upgrade

This screen lets you upload new firmware to your Zyxel Device.

Get the latest firmware from your service provider. Then upload the firmware file to your Zyxel Device. The upload process uses HTTP (Hypertext Transfer Protocol). The upload may take up to 3 minutes. After a successful upload, the Zyxel Device will reboot.

Click **Maintenance > Firmware Upgrade** to open the **following** screen.

**Do NOT turn off the Zyxel Device while firmware upload is in progress!**

**Figure 273** Maintenance > Firmware Upgrade

The screenshot shows the 'Firmware Upgrade' web interface. At the top, the title 'Firmware Upgrade' is centered. Below the title, there is a text box containing instructions: 'This screen lets you upload new firmware to your Zyxel Device.' followed by 'Download the latest firmware file from the Zyxel website and upload it to your Zyxel Device using this screen. The upload process uses HTTP (Hypertext Transfer Protocol) and may take up to two minutes. After a successful upload, the Zyxel Device will reboot.' Below this, there are two sections for settings: 'Restore Partial Default Settings After Firmware Upgrade' and 'Reset All Settings Except Mesh After Firmware Upgrade', both with checkboxes. The 'Current Firmware Version' is displayed as 'V5.18(ACHN.0)b2'. There are two 'File Path' input fields, each with a 'Choose File' button and 'No file chosen' text. To the right of each 'File Path' field is a yellow 'Upload' button. Below the 'File Path' fields, there is a section for 'Upgrade WWAN Package' with 'Current WWAN Package Version: 1.24' and another 'File Path' field with 'Choose File' and 'No file chosen' text, and a yellow 'Upload' button.

The following table describes the labels in this screen.

Table 190 Maintenance &gt; Firmware Upgrade

LABEL	DESCRIPTION
Upgrade Firmware	
Restore Default Settings After Firmware Upgrade	<p>Select this to reset all your configurations, including Mesh WiFi settings, to the factory defaults after firmware upgrade. Otherwise, make sure this is cleared if you do not want the Zyxel Device to lose all its current configurations and return to the factory defaults.</p> <p>Note: Make sure to back up the Zyxel Device's configuration settings first in case the reset all settings process is not successful. Refer to <a href="#">Section 43.2 on page 492</a>.</p>
Reset All Settings Except Mesh After Firmware Upgrade	<p>Select this to reset all your configurations, except for Mesh WiFi settings, to the factory defaults after firmware upgrade. This minimizes interruption to your Mesh WiFi network after upgrading firmware.</p> <p>Mesh WiFi settings include:</p> <ul style="list-style-type: none"> <li>• Controller/Agent Mode</li> <li>• Mesh Internet Access</li> <li>• Main and Guest SSIDs including Guest WiFi isolation</li> <li>• 2.4GHz &amp; 5GHz Radios</li> <li>• 802.11 Mode</li> <li>• Protected Management Frames</li> <li>• Encryption and WPA keys</li> </ul>
Current Firmware Version	This is the current firmware version.
File Path	Enter the location of the file you want to upload in this field or click <b>Choose File/Browse</b> to find it.
Choose File/Browse	Click this to find the .bin file you want to upload. Remember that you must decompress compressed (.zip) files before you can upload them.
Upload	<p>Click this to begin the upload process. This process may take up to 3 minutes.</p> <p>Note: Only use firmware for your Zyxel Device's specific model. Refer to the label on the bottom of your Zyxel Device. For example, if the Zyxel Device's current firmware version is V5.70(ACDZ.0)B4, you must upload the firmware file containing "ACDZ".</p>
Upgrade WWAN Package	
Current WWAN Package Version	This is the current version or the WWAN (Wireless Wide Area Network) package installed in the Zyxel Device. A WWAN package adds support for more 4G USB dongles without you having to upgrade the Zyxel Device's firmware.
File Path	Enter the location of the file you want to upload in this field or click <b>Choose File/Browse</b> to find it.
Choose File/Browse	Click this to find the .bin file you want to upload. Remember that you must decompress compressed (.zip) files before you can upload them.
Upload	Click this to begin the upload process. This process may take up to 3 minutes.

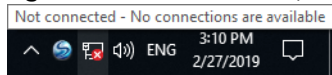
After you see the firmware updating screen, wait a few minutes before logging into the Zyxel Device again.

Figure 274 Firmware Uploading



The Zyxel Device automatically restarts in this time causing a temporary network disconnect. In some operating systems, you may see the following icon on your desktop.

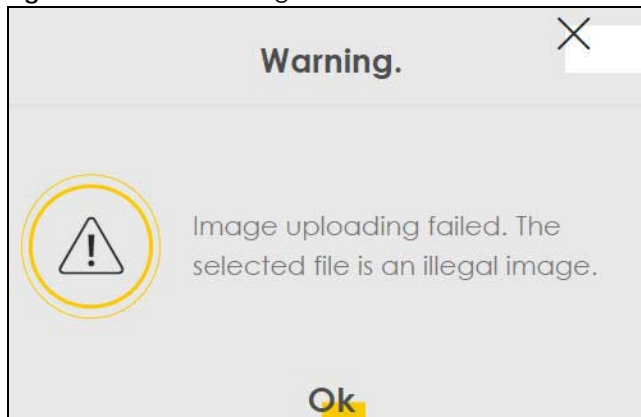
Figure 275 Network Temporarily Disconnected



After 2 minutes, log in again and check your new firmware version in the **Connection Status** screen.

If the upload was not successful, an error screen will appear. Click **OK** to go back to the **Firmware Upgrade** screen.

Figure 276 Error Message



# CHAPTER 43

## Backup/Restore

### 43.1 Backup/Restore Overview

Information related to factory default settings and backup configuration are shown in this screen. You can also use this to restore Zyxel Device's previous configurations.

### 43.2 Backup/Restore

Click **Maintenance > Backup/Restore**. Information related to factory defaults, backup configuration, and restoring configuration appears in this screen, as shown next.

Figure 277 Maintenance &gt; Backup/Restore

Information related to factory default settings and backup configuration are shown in this screen. You can also use this to restore previous device configurations.

Backup Configuration allows you to back up (save) the Zyxel Device's current configuration to a file on your computer. Once your Zyxel Device is configured and functioning properly, it is highly recommended that you back up your configuration file before making configuration changes.

Restore Configuration allows you to upload a new or previously saved configuration file from your computer to your Zyxel Device.

### Backup Configuration

Click Backup to save the current configuration of your system to your computer.

**Backup**

### Restore Configuration

To restore a previously saved configuration file to your system, browse to the location of the configuration file and click Upload.

File Path  Choose File No file chosen **Upload**

### Reset All Settings

Click Reset to clear all user-entered configuration information and return to factory default settings. After resetting, the

- Password is printed on a label on the bottom of the device, written after the text "Password".
- LAN IP address will be 192.168.1.1
- DHCP will be reset to default setting

**Reset**

### Reset All Settings Except Mesh

You can keep certain user configurables while bringing the reset of the device to factory default setting.

- System will keep Wi-fi settings, include these user settings (Mesh Enable/Disable, Mesh Controller Mode, Mesh Backhaul information, Single SSID Enable/Disable, SSIDs, WPA keys, Encryption modes, 2.4GHz Enable/Disable, 5GHz Enable/Disable, Guest Wi-Fi Enable/Disable, Guest Wi-Fi isolation setting, 802.11 Mode, Protected MGMT Frames setting)

**Reset All Except Mesh**

## Backup Configuration

**Backup Configuration** allows you to back up (save) the Zyxel Device's current configuration to a file on your computer. Once your Zyxel Device is configured and functioning properly, it is highly recommended that you back up your configuration file before making configuration changes. The backup configuration file will be useful in case you need to return to your previous settings.

Click **Backup** to save the Zyxel Device's current configuration to your computer.

## Restore Configuration

**Restore Configuration** allows you to upload a new or previously saved configuration file from your computer to your Zyxel Device.

Table 191 Maintenance > Backup/Restore: Restore Configuration

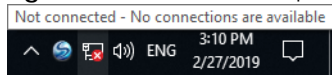
LABEL	DESCRIPTION
File Path	Enter in the location of the file you want to upload in this field or click <b>Choose File / Browse</b> to find it.
Choose File / Browse	Click this to find the file you want to upload. Remember that you must decompress compressed (.ZIP) files before you can upload them.
Upload	Click this to begin the upload process.
Reset	Click this to reset your Zyxel Device settings back to the factory default.

**Do not turn off the Zyxel Device while configuration file upload is in progress.**

After the Zyxel Device configuration has been restored successfully, the login screen appears. Login again to restart the Zyxel Device.

The Zyxel Device automatically restarts in this time causing a temporary network disconnect. In some operating systems, you may see the following icon on your desktop.

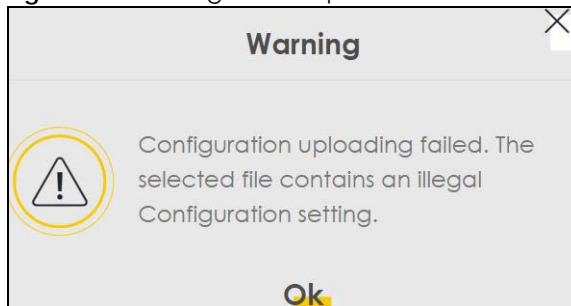
**Figure 278** Network Temporarily Disconnected



If you restore the default configuration, you may need to change the IP address of your computer to be in the same subnet as that of the default Zyxel Device IP address (192.168.1.1-192.168.225.225).

If the upload was not successful, an error screen will appear. Click **OK** to go back to the **Configuration** screen.

**Figure 279** Configuration Upload Error



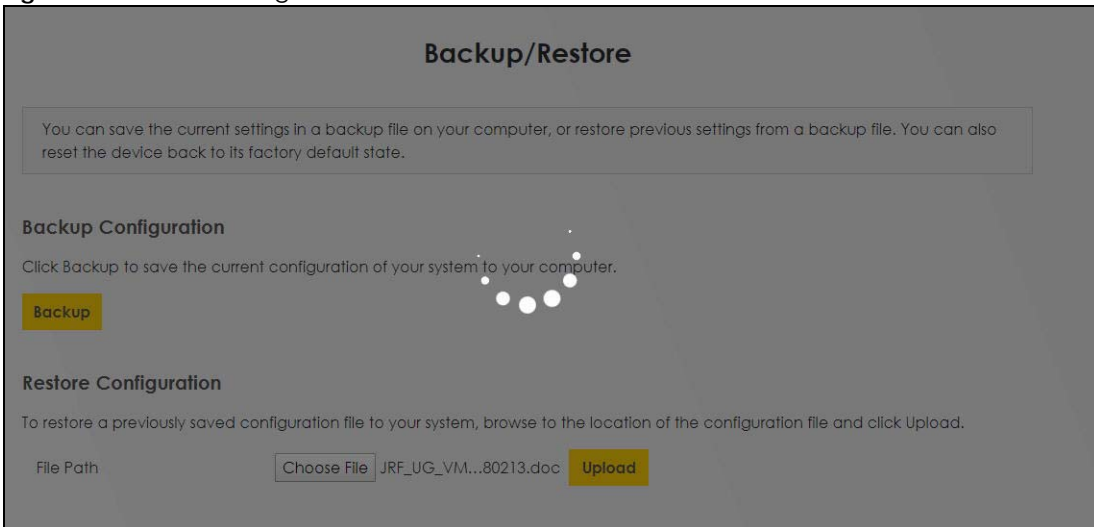
## Reset All Settings

Click the **Reset** button to clear all user-entered configuration information and return the Zyxel Device to its factory defaults. The following warning screen appears.

Figure 280 Reset Warning Message



Figure 281 Reset In Progress



You can also press the **RESET** button on the panel to reset the factory defaults of your Zyxel Device.

## Reset All Settings Except Mesh

Click the **Reset All Except Mesh** button to clear all user-entered configuration information and return the Zyxel Device to its factory defaults except for Mesh WiFi settings. The following warning screen appears.

Figure 282 Reset Warning Message

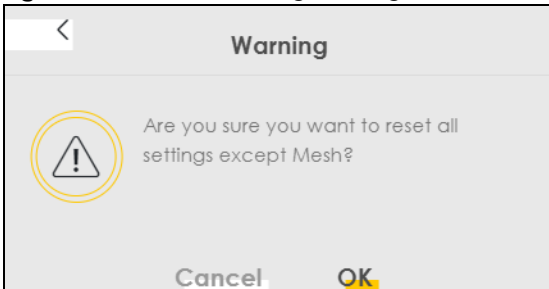
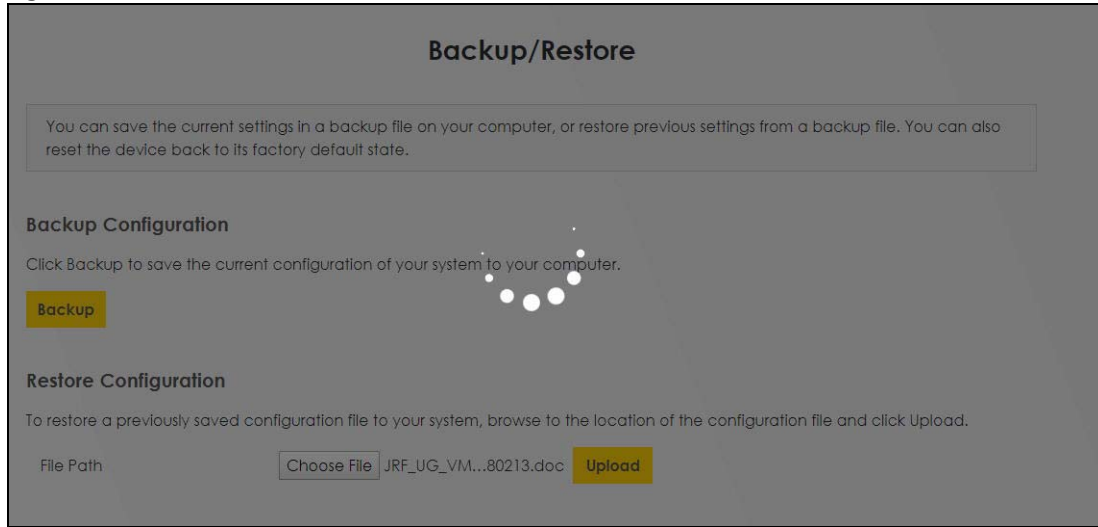


Figure 283 Reset In Process

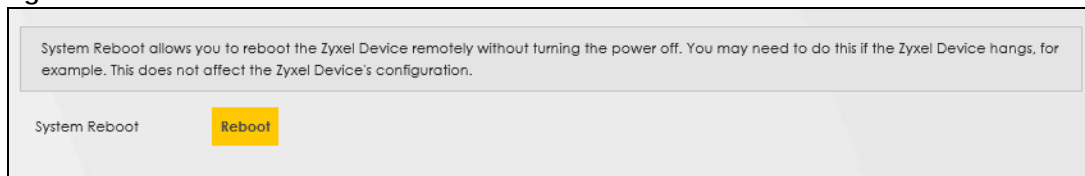


## 43.3 Reboot

System **Reboot** allows you to reboot the Zyxel Device remotely without turning the power off. You may need to do this if the Zyxel Device hangs, for example. This does not affect the Zyxel Device's configuration.

Click **Maintenance > Reboot**. Click **Reboot** to have the Zyxel Device reboot.

Figure 284 Maintenance &gt; Reboot





# CHAPTER 44

## Diagnostic

### 44.1 Diagnostic Overview

The **Diagnostic** screen displays information to help you identify problems with the Zyxel Device.

The route between an Ethernet switch and one of its Customer-Premises Equipment (CPE) may go through switches owned by independent organizations. A connectivity fault point generally takes time to discover and impacts subscriber's network access. In order to eliminate the management and maintenance efforts, IEEE 802.1ag is a Connectivity Fault Management (CFM) specification which allows network administrators to identify and manage connection faults. Through discovery and verification of the path, CFM can detect, analyze and isolate connectivity faults in bridged LANs.

#### 44.1.1 What You Can Do in this Chapter

- The **Ping&Traceroute&Nslookup** screen lets you ping an IP address or trace the route packets take to a host ([Section 44.3 on page 498](#)).
- The **802.1ag** screen lets you perform CFM actions ([Section 44.4 on page 499](#)).
- The **802.3ah** screen lets you configure link OAM port parameters ([Section 44.5 on page 500](#)).
- The **OAM Ping** screen lets you send an ATM OAM (Operation, Administration and Maintenance) packet to verify the connectivity of a specific PVC ([Section 44.6 on page 501](#)).

### 44.2 What You Need to Know

The following terms and concepts may help as you read through this chapter.

#### How CFM Works

A Maintenance Association (MA) defines a VLAN and associated Maintenance End Point (MEP) ports on the device under a Maintenance Domain (MD) level. An MEP port has the ability to send Connectivity Check Messages (CCMs) and get other MEP ports information from neighbor devices' CCMs within an MA.

CFM provides two tests to discover connectivity faults.

- Loopback test – checks if the MEP port receives its Loop Back Response (LBR) from its target after it sends the Loop Back Message (LBM). If no response is received, there might be a connectivity fault between them.
- Link trace test – provides additional connectivity fault analysis to get more information on where the fault is. If an MEP port does not respond to the source MEP, this may indicate a fault. Administrators can take further action to check and resume services from the fault according to the line connectivity status report.

## 44.3 Diagnostic

Use this screen to ping, traceroute, nslookup, or speed test for troubleshooting. Ping and traceroute are used to test whether a particular host is reachable. After entering an IP address and clicking one of the buttons to start a test, the results will be shown in the **Ping/Traceroute Test** area. Use nslookup to find the IP address for a host name and vice versa. Use speed test to determine the download and upload speed.

Click **Maintenance > Diagnostic** to open the following screen.

**Figure 285** Maintenance > Diagnostic

The **Diagnostic** screens display information to help you identify problems with the Zyxel Device.

Use this screen to ping, traceroute, or nslookup for troubleshooting. Ping and traceroute are used to test whether a particular host is reachable. After entering an IP address and clicking on one of the buttons to start a test, the results will be shown in the Ping/Traceroute Test area. Use nslookup to find the IP address for a host name and vice versa.

**Diagnostic Test**

TCP/IP

Address

Ping Ping 6 Trace Route Trace Route 6 Nslookup

The following table describes the fields in this screen.

Table 192 Maintenance > Diagnostic

LABEL	DESCRIPTION
Ping/TraceRoute Test (Diagnostic Test)	The result of tests is shown here in the info area.
TCP/IP	
Address	Enter the IP address of a computer that you want to perform ping, traceroute, or nslookup in order to test a connection.
Ping	Click this button to perform a ping test on the IPv4 address or host name in order to test a connection. The ping statistics will show in the info area.
Ping 6	Click this button to perform a ping test on the IPv6 address or host name in order to test a connection. The ping statistics will show in the info area.
Trace Route	Click this button to perform the IPv4 trace route function. This determines the path a packet takes to the specified host.
Trace Route 6	Click this button to perform the IPv6 trace route function. This determines the path a packet takes to the specified host.
Nslookup	Click this button to perform a DNS lookup on the IP address or host name.

## 44.4 802.1ag (CFM)

Click **Maintenance > Diagnostic > 802.1ag** to open the following screen. Use this screen to configure and perform Connectivity Fault Management (CFM) actions as defined by the IEEE 802.1ag standard. CFM protocols include Continuity Check Protocol (CCP), Link Trace (LT), and Loopback (LB).

**Figure 286** Maintenance > Diagnostic > 802.1ag

The following table describes the fields in this screen.

Table 193 Maintenance > Diagnostic > 802.1ag



LABEL	DESCRIPTION
802.1ag Connectivity Fault Management	
IEEE 802.1ag CFM	Click this switch to enable or disable the IEEE802.1ag CFM specification, which allows network administrators to identify and manage connection faults. When the switch goes to the right  , the function is enabled. Otherwise, it is not.
Y.1731	Click this switch to enable or disable Y.1731, which monitors Ethernet performance. When the switch goes to the right  , the function is enabled. Otherwise, it is not.
Interface	Select the interface on which you want to enable the IEE 802.1ag CFM.

Table 193 Maintenance &gt; Diagnostic &gt; 802.1ag (continued)

LABEL	DESCRIPTION
Maintenance Domain (MD) Level	Select a level (0 – 7) under which you want to create an MA.
MD Name	Enter a descriptive name for the MD (Maintenance Domain). This field only appears if the <b>Y.1731</b> field is disabled.
MA ID	Enter a descriptive name to identify the Maintenance Association. This field only appears if the <b>Y.1731</b> field is disabled.
MEG ID	Enter a descriptive name to identify the Maintenance Entity Group. This field only appears if the <b>Y.1731</b> field is enabled.
802.1Q VLAN ID	Enter a VLAN ID (1 – 4094) for this MA.
Local MEP ID	Enter the local Maintenance Endpoint Identifier (1 – 8191).
CCM	Click the switch to the right <input checked="" type="checkbox"/> to continue sending MEP information by CCM (Connectivity Check Messages).  When CCMs are received the Zyxel Device will always process it, whether <b>CCM</b> is enabled or not.
Remote MEP ID	Enter the remote Maintenance Endpoint Identifier (1 – 8191).
Test the connection to another Maintenance End Point (MEP)	
Destination MAC Address	Enter the target device's MAC address to which the Zyxel Device performs a CFM loopback and linktrace test.
Test Result	
Loopback Message (LBM)	This shows <b>Pass</b> if a Loop Back Messages (LBMs) responses are received. If LBMs do not get a response it shows <b>Fail</b> .
Linktrace Message (LTM)	This shows the MAC address of MEPs that respond to the LTMs.
Apply	Click this button to save your changes.
Send Loopback	Click this button to have the selected MEP send the LBM (Loop Back Message) to a specified remote end point.
Send Linktrace	Click this button to have the selected MEP send the LTMs (Link Trace Messages) to a specified remote end point.



## 44.5 802.3ah (OAM)

Click **Maintenance > Diagnostic > 803.ah** to open the following screen. Link layer Ethernet OAM (Operations, Administration and Maintenance) as described in IEEE 802.3ah is a link monitoring protocol. It utilizes OAM Protocol Data Units (OAM PDU's) to transmit link status information between directly connected Ethernet devices. Both devices must support IEEE 802.3ah.

Figure 287 Maintenance &gt; Diagnostic &gt; 802.3ah

The following table describes the labels in this screen.

Table 194 Maintenance &gt; Diagnostics &gt; 802.3ah

LABEL	DESCRIPTION
IEEE 802.3ah Ethernet OAM	Click this switch to enable or disable the Ethernet OAM on the specified interface. When the switch goes to the right  , the function is enabled. Otherwise, it is not.
Interface	Select the interface on which you want to enable the IEEE802.3ah.
OAM ID	Enter a positive integer to identify this node.
Auto Event	Click this switch to detect link status and send a notification when an error (such as errors in symbol, frames, or seconds) is detected. Otherwise, disable this and you will not be notified. When the switch goes to the right  , the function is enabled. Otherwise, it is not.
Features	<p>Select <b>Variable Retrieval</b> so the Zyxel Device can respond to requests for information, such as requests for Ethernet counters and statistics, about link events.</p> <p>Select <b>Link Events</b> so the Zyxel Device can interpret link events, such as link fault and dying asp.Link events are set in event notification PDUs (Protocol Data Units), and indicate when the number of errors in a certain given interval (time, number of frames, number of symbols, or number of error frame seconds) exceeds a specified threshold. Organizations may create organization-specific link event TLVs as well.</p> <p>Select <b>Remote Loopback</b> so the Zyxel Device can accept loopback control PDUs to convert Zyxel Device into loopback mode.</p> <p>Select <b>Active Mode</b> so the Zyxel Device initiates OAM discovery, send information PDUs; and may send event notification PDUs, variable request/response PDUs, or loopback control PDUs.</p>
Apply	Click this button to save your changes.

## 44.6 OAM Ping

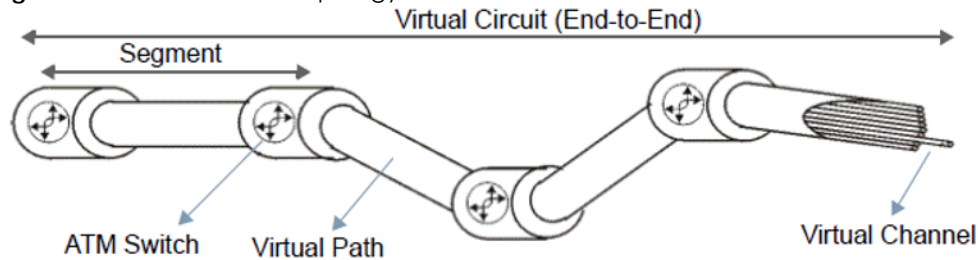
Click **Maintenance > Diagnostic > OAM Ping** to open the screen shown next. Use this screen to perform an OAM (Operation, Administration and Maintenance) F4 or F5 loopback test on a PVC. The DX5301-B2/

B3 sends an OAM F4 or F5 packet to the DSLAM or ATM switch and then returns it to the DX5301-B2/B3. The test result then displays in the text box.

ATM sets up virtual circuits over which end systems communicate. The terminology for virtual circuits is as follows:

- Virtual Channel (VC) Logical connections between ATM devices
- Virtual Path (VP) A bundle of virtual channels
- Virtual Circuits A series of virtual paths between circuit end points

**Figure 288** Virtual Circuit Topology



Think of a virtual path as a cable that contains a bundle of wires. The cable connects two points and wires within the cable provide individual circuits between the two points. In an ATM cell header, a VPI (Virtual Path Identifier) identifies a link formed by a virtual path; a VCI (Virtual Channel Identifier) identifies a channel within a virtual path. A series of virtual paths make up a virtual circuit.

F4 cells operate at the virtual path (VP) level, while F5 cells operate at the virtual channel (VC) level. F4 cells use the same VPI as the user data cells on VP connections, but use different predefined VCI values. F5 cells use the same VPI and VCI as the user data cells on the VC connections, and are distinguished from data cells by a predefined Payload Type Identifier (PTI) in the cell header. Both F4 flows and F5 flows are bidirectional and have two types.

- segment F4 flows (VCI=3)
- end-to-end F4 flows (VCI=4)
- segment F5 flows (PTI=100)
- end-to-end F5 flows (PTI=101)

OAM F4 or F5 tests are used to check virtual path or virtual channel availability between two DSL devices. Segment flows are terminated at the connecting point which terminates a VP or VC segment. End-to-end flows are terminated at the end point of a VP or VC connection, where an ATM link is terminated. Segment loopback tests allow you to verify integrity of a PVC to the nearest neighboring ATM device. End-to-end loopback tests allow you to verify integrity of an end-to-end PVC.

Note: The DSLAM to which the DX5301-B2/B3 is connected must also support ATM F4 and/or F5 to use this test.

Note: This screen is available only when you configure an ATM layer-2 interface using DX5301-B2/B3.

Figure 289 Maintenance &gt; Diagnostic &gt; OAM Ping

The following table describes the labels in this screen.

Table 195 Maintenance &gt; Diagnostics &gt; OAM Ping

LABEL	DESCRIPTION
Select a PVC on which you want to perform the loopback test.	
F4 segment	Press this to perform an OAM F4 segment loopback test.
F4 end-end	Press this to perform an OAM F4 end-to-end loopback test.
F5 segment	Press this to perform an OAM F5 segment loopback test.
F5 end-end	Press this to perform an OAM F5 end-to-end loopback test.

---

# PART III

# Troubleshooting and Appendices

---

Appendices contain general information. Some information may not apply to your Zyxel Device.



# CHAPTER 45

# Troubleshooting

## 45.1 Troubleshooting Overview

This chapter offers some suggestions to solve problems you might encounter. The potential problems are divided into the following categories.

- [Power and Hardware Problems](#)
- [Device Access Problems](#)
- [Internet Problems](#)
- [WiFi Problems](#)
- [USB Problems](#)
- [VoIP Problems](#)
- [UPnP Problems](#)

## 45.2 Power and Hardware Problems

---

[The Zyxel Device does not turn on.](#)

---

- 1 Make sure you are using the power adapter included with the Zyxel Device.
- 2 Make sure the power adapter is connected to the Zyxel Device and plugged in to an appropriate power source. Make sure the power source is turned on.
- 3 Disconnect and re-connect the power adapter to the Zyxel Device.
- 4 Make sure you have pressed the **POWER** button to turn on the Zyxel Device.
- 5 If the problem continues, contact the vendor.

---

[The LED does not behave as expected.](#)

---

- 1 Make sure you understand the normal behavior of the LED.
- 2 Check the hardware connections.

- 3 Inspect your cables for damage. Contact the vendor to replace any damaged cables.
- 4 Turn the Zyxel Device off and on.
- 5 If the problem continues, contact the vendor.

## 45.3 Device Access Problems

---

### I do not know the IP address of the Zyxel Device.

---

- 1 The default IP address is 192.168.1.1
- 2 If you changed the IP address, you might be able to find the IP address of the Zyxel Device by looking up the IP address of your computer's default gateway. To do this in Microsoft Windows, click **Start > Run**, enter **cmd**, and then enter **ipconfig**. The IP address of the **Default Gateway** might be the IP address of the Zyxel Device, depending on your network environment.
- 3 If this does not work, reset the Zyxel Device to its factory defaults.

---

### I forgot the admin password.

---

- 1 See the Zyxel Device label or this document's cover page for the default admin password.
- 2 If you changed the password from default and cannot remember the new one, you have to reset the Zyxel Device to its factory default settings.

---

### I cannot access the Web Configurator login screen.

---

- 1 Make sure you are using the correct IP address.
  - The default IP address is 192.168.1.1.
  - If you changed the IP address ([Section 10.2 on page 361](#)), use the new IP address.
  - If you changed the IP address and have forgotten the new address, see the troubleshooting suggestions for [I do not know the IP address of the Zyxel Device](#).
- 2 Check the hardware connections, and make sure the LEDs are behaving as expected.
- 3 Make sure your Internet browser does not block pop-up windows and has JavaScript and Java enabled.
- 4 If it is possible to log in from another interface, check the service control settings for HTTP and HTTPS (**Maintenance > Remote Management**).

- 5 Reset the Zyxel Device to its factory default, and try to access the Zyxel Device with the default IP address.
- 6 If the problem continues, contact the network administrator or vendor, or try one of the advanced suggestions.

#### Advanced Suggestions

- Make sure you have logged out of any earlier management sessions using the same user account even if they were through a different interface or using a different browser.
- Try to access the Zyxel Device using another service, such as Telnet. If you can access the Zyxel Device, check the remote management settings and firewall rules to find out why the Zyxel Device does not respond to HTTP.

---

#### I cannot log into the Zyxel Device.

---

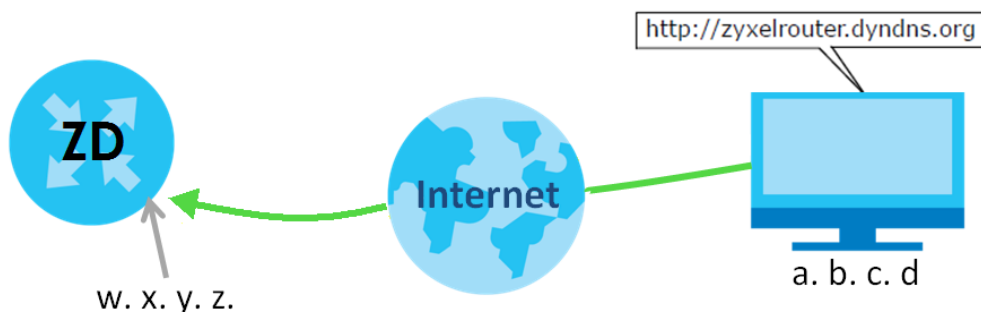
- 1 Make sure you have entered the user name and password correctly. The default user name is **admin**. These both user name and password are case-sensitive, so make sure [Caps Lock] is not on.
- 2 You cannot log in to the Web Configurator while someone is using Telnet to access the Zyxel Device. Log out of the Zyxel Device in the other session, or ask the person who is logged in to log out.
- 3 Turn the Zyxel Device off and on.
- 4 If this does not work, you have to reset the Zyxel Device to its factory default.

---

#### I cannot log into the Zyxel Device using DDNS.

---

If you connect your Zyxel Device to the Internet and it uses a dynamic WAN IP address, it is inconvenient for you to manage the Zyxel Device from the Internet. The Zyxel Device's WAN IP address changes dynamically. Dynamic DNS (DDNS) allows you to access the Zyxel Device using a domain name.



To use this feature, you have to apply for DDNS service at [www.dyndns.org](http://www.dyndns.org).

Note: If you have a private WAN IP address, then you cannot use DDNS.

Here are the three steps to use a domain name to log in the Web Configurator:

### Step 1 Register for a DDNS Account on [www.dyndns.org](http://www.dyndns.org)

- 1 Open a browser and enter <http://www.dyndns.org>.
- 2 Apply for a user account. This tutorial uses **UserName1** and **12345** as the username and password.
- 3 Log into [www.dyndns.org](http://www.dyndns.org) using your account.
- 4 Add a new DDNS host name. This tutorial uses the following settings as an example.
  - Hostname: **zyxelrouter.dyndns.org**
  - Service Type: **Host with IP address**
  - IP Address: Enter the WAN IP address that your Zyxel Device is currently using. You can find the IP address on the Zyxel Device's Web Configurator **Status** page.

Then you will need to configure the same account and host name on the Zyxel Device later.

### Step 2 Configure DDNS on Your Zyxel Device

Configure the following settings in the **Network Setting > DNS > Dynamic DNS** screen.

- Select **Enable Dynamic DNS**.
- Select **www.DynDNS.com** as the service provider.
- Enter **zyxelrouter.dyndns.org** in the **Host Name** field.
- Enter the user name (**UserName1**) and password (**12345**). Click **Apply**.

### Step 3 Test the DDNS Setting

Now you should be able to access the Zyxel Device from the Internet. To test this:

- 1 Open a web browser on the computer (using the IP address **a.b.c.d**) that is connected to the Internet.
- 2 Enter <http://zyxelrouter.dyndns.org> and press [Enter].
- 3 The Zyxel Device's login page should appear. You can then log into the Zyxel Device and manage it.

---

[I cannot connect to the Zyxel Device using FTP, Telnet, SSH, or Ping.](#)

---

- 1 See the Remote Management section for details on allowing web services (such as HTTP, HTTPS, FTP, Telnet, SSH and Ping) to access the Zyxel Device.
- 2 Check the server **Port** number field for the web service in the **Maintenance > Remote Management** screen. You must use the same port number in order to use that web service for remote management.
- 3 Try the troubleshooting suggestions for [I cannot access the Web Configurator login screen](#). Ignore the suggestions about your browser.

---

The SIM card cannot be detected.

---

- 1 Disconnect the Zyxel Device from the power supply.
- 2 Remove the SIM card from its slot.
- 3 Clean the SIM card slot of any loose debris using compressed air.
- 4 Clean the gold connectors on the SIM card with a clean lint-free cloth.
- 5 Insert the SIM card into its slot and connect the Zyxel Device to the power supply to restart it.

---

I get an **Invalid SIM card alert**.

---

- 1 Make sure you have an active plan with your ISP.
- 2 Make sure that the Zyxel Device is in the coverage area of a cellular network.

## 45.4 Internet Problems

---

I cannot access the Internet.

---

- 1 Check the hardware connections and make sure the LEDs are behaving as expected. See the **Quick Start Guide**.
- 2 Make sure you entered your ISP account information correctly on the **Network Setting > Broadband** screen. Fields on this screen are case-sensitive, so check if [Caps Lock] is on or off.
- 3 If you are trying to access the Internet wirelessly, make sure that you enabled the WiFi in the Zyxel Device and your WiFi client and that the WiFi settings in the WiFi client are the same as the settings in the Zyxel Device.
- 4 Disconnect all the cables from your Zyxel Device and reconnect them.
- 5 If the problem continues, contact your ISP.

---

I cannot connect to the Internet using an Ethernet connection.

---

- 1 Make sure you have the Ethernet WAN port connected to a Modem or Router.

- 2 Make sure you configured a proper Ethernet WAN interface (**Network Setting > Broadband** screen) with the Internet account information provided by your ISP and that it is enabled.
- 3 Check that the WAN interface you are connected to is in the same interface group as the Ethernet connection (**Network Setting > Interface Group**).
- 4 If you set up a WAN connection using bridging service, make sure you turn off the DHCP feature in the **Network Setting > Home Networking > LAN Setup** screen to have the clients get WAN IP addresses directly from your ISP's DHCP server.

---

### I cannot connect to the Internet using a Fiber connection.

---

- 1 Make sure the Fiber/SFP port has a compatible SFP/SFP+ transceiver installed with a fiber/Ethernet cable connected to it.
- 2 Check the hardware connections, and make sure the LEDs are behaving as expected. See the **Quick Start Guide**.

The **PON** LED is off if the optical transceiver has malfunctioned or the fiber cable is not connected or is broken or damaged enough to break the PON connection.

The **LOS** LED is red if the GPON Device is not receiving an optical signal.

The **LOS** LED blinks red if the GPON Device is receiving a weak optical signal.

- 3 Disconnect all the cables from your device and reconnect them. Make sure the fiber cable is not curved too much.
- 4 If that does not work, restart your Zyxel Device.
- 5 If the problems continues, contact your ISP.

---

### I cannot connect to the Internet using a cellular connection.

---

- 1 The DSL and Ethernet connections have priority in that order. If the DSL or Ethernet connection is up, then the cellular connection will be down.
- 2 Make sure you have connected a compatible cellular dongle to the USB port, if required.
- 3 Make sure you have configured **Network Setting > Broadband > Cellular Backup** correctly.
- 4 Check that the Zyxel Device is within range of a cellular base station.

---

### The Internet connection is slow or intermittent.

---

- 1 There might be a lot of traffic on the network. If the Zyxel Device is sending or receiving a lot of information, try closing some programs that use the Internet, especially peer-to-peer applications.
- 2 Check the signal strength. Look at the LEDs, and check the LED section for more information. If the signal strength is low, try moving the Zyxel Device closer to the ISP's base station if possible, and look around to see if there are any devices that might be interfering with the wireless network (such as microwaves, other wireless networks).
- 3 Turn the Zyxel Device off and on.
- 4 If the problem continues, contact the network administrator or vendor, or try the advanced suggestions in [I cannot access the Web Configurator login screen](#).

Note: If your Zyxel Device is an outdoor-type, inclement weather like rain and hot weather may affect cellular signals.

## 45.5 WiFi Problems

---

### [I cannot connect to the Zyxel Device WiFi.](#)

---

- 1 Check the WiFi LED status to make sure the Zyxel Device WiFi is on.
- 2 Make sure your WiFi client is within transmission range of the Zyxel Device.
- 3 Make sure you entered the correct SSID and password. See the Zyxel Device back label for the default SSID and password.
- 4 Make sure your WiFi client is using the same WiFi security type (WPA2-PSK, WPA3-SAE, or none) as the Zyxel Device.
- 5 Make sure the WiFi adapter on your WiFi client is working properly. Right-click your computer's network adapter then select **Properties** to check your network adapter status.
- 6 Make sure the WiFi adapter on your WiFi client is IEEE 802.11-compatible and supports the same WiFi standard as the Zyxel Device radio.

---

### [The WiFi connection is slow and intermittent.](#)

---

The following factors may cause interference:

- Obstacles: walls, ceilings, furniture, and so on.
- Building Materials: metal doors, aluminum studs.
- Electrical devices: microwaves, monitors, electric motors, cordless phones, and other wireless devices.

To optimize the speed and quality of your WiFi connection, you can:

- Move your wireless device closer to the AP if the signal strength is low.
- Reduce wireless interference that may be caused by other WiFi networks or surrounding wireless electronics such as cordless phones.
- Place the AP where there are minimum obstacles (such as walls and ceilings) between the AP and the WiFi client.
- Reduce the number of WiFi clients connecting to the same AP simultaneously, or add additional APs if necessary.
- Try closing some programs that use the Internet, especially peer-to-peer applications. If the WiFi client is sending or receiving a lot of information, it may have too many programs open that use the Internet.
- Place the Zyxel Device where there are minimum obstacles (such as walls and ceilings) between the Zyxel Device and the WiFi client. Avoid placing the Zyxel Device inside any type of box that might block WiFi signals.

## 45.6 USB Problems

---

The Zyxel Device fails to detect my USB device.

---

- 1 Disconnect the USB device.
- 2 Reboot the Zyxel Device.
- 3 If you are connecting a USB hard drive that comes with an external power supply, make sure it is connected to an appropriate power source that is on.
- 4 Reconnect your USB device to the Zyxel Device.

## 45.7 VoIP Problems

---

I cannot make phone calls through the phone connected to the Zyxel Device.

---

- 1 Pick up the phone and check the phone tone. You should hear the dial tone if your configuration on the Zyxel Device is correct, and your phone is successfully connected to the SIP server.
- 2 Make sure your phone is connected to the Zyxel Device phone port through an RJ-11 cable. Check the Zyxel Device phone LED for the corresponding phone status.
- 3 Make sure the Zyxel Device has an Internet connection. See [Section 45.4 on page 509](#) for more information.



- 4 Make sure your SIP account is registered and your SIP service plan is valid. Use the **System Monitor > VoIP Status** screen to check the account **Registration** status.
- 5 Make sure your SIP server settings (in the **VoIP > SIP > SIP Service Provider** and the **VoIP > SIP > SIP Account** screens) use the correct information from your SIP service provider. For example, your SIP service provider name, SIP account and password.
- 6 Make sure your phone settings (in the **VoIP > Phone > Phone Device** screen) are correct.
- 7 Contacting the SIP server administrator and make sure your SIP server isn't down.

## 45.8 UPnP Problems

---

[My computer cannot detect UPnP settings from the Zyxel Device.](#)

---

- 1 Make sure that UPnP is enabled in your computer. For Windows 10, see [Section 10.12 on page 386](#).
- 2 On the Zyxel Device, make sure that UPnP is enabled on the **Network Settings > Home Networking > UPnP** screen. See [Section 10.4 on page 374](#) for details.
- 3 Disconnect the Ethernet cable from the Zyxel Device's Ethernet port or from your computer.
- 4 Reconnect the Ethernet cable.
- 5 Restart your computer.

## 45.9 Getting More Troubleshooting Help

Search for support information for your model at <https://service-provider.zyxel.com/global/en/tech-support> and [community.zyxel.com](https://community.zyxel.com) for more troubleshooting suggestions.

# APPENDIX A

## Customer Support

In the event of problems that cannot be solved by using this manual, you should contact your vendor. If you cannot contact your vendor, then contact a Zyxel office for the region in which you bought the device.

For Zyxel Communication offices, see <https://service-provider.zyxel.com/global/en/contact-us> for the latest information.

For Zyxel Network offices, see <https://www.zyxel.com/index.shtml> for the latest information.

Please have the following information ready when you contact an office.

### Required Information

- Product model and serial number.
- Warranty Information.
- Date that you received your device.
- Brief description of the problem and the steps you took to solve it.

### Corporate Headquarters (Worldwide)

#### Taiwan

- Zyxel Communications (Taiwan) Co., Ltd.
- <https://www.zyxel.com>

### Asia

#### China

- Zyxel Communications Corporation–China Office
- <https://www.zyxel.com/cn/sc>

#### India

- Zyxel Communications Corporation–India Office
- <https://www.zyxel.com/in/en-in>

#### Kazakhstan

- Zyxel Kazakhstan
- <https://www.zyxel.com/ru/ru>

## **Korea**

- Zyxel Korea Co., Ltd.
- <http://www.zyxel.kr/>

## **Malaysia**

- Zyxel Communications Corp.
- <https://www.zyxel.com/global/en>

## **Philippines**

- Zyxel Communications Corp.
- <https://www.zyxel.com/global/en>

## **Singapore**

- Zyxel Communications Corp.
- <https://www.zyxel.com/global/en>

## **Taiwan**

- Zyxel Communications (Taiwan) Co., Ltd.
- <https://www.zyxel.com/tw/zh>

## **Thailand**

- Zyxel Thailand Co., Ltd.
- <https://www.zyxel.com/th/th>

## **Vietnam**

- Zyxel Communications Corporation–Vietnam Office
- <https://www.zyxel.com/vn/vi>

## **Europe**

### **Belarus**

- Zyxel Communications Corp.
- <https://www.zyxel.com/ru/ru>

### **Belgium (Netherlands)**

- Zyxel Benelux
- <https://www.zyxel.com/nl/nl>
- <https://www.zyxel.com/fr/fr>

### **Bulgaria**

- Zyxel Bulgaria

- <https://www.zyxel.com/bg/bg>

## **Czech Republic**

- Zyxel Communications Czech s.r.o.
- <https://www.zyxel.com/cz/cs>

## **Denmark**

- Zyxel Communications A/S
- <https://www.zyxel.com/dk/da>

## **Finland**

- Zyxel Communications
- <https://www.zyxel.com/fi/fi>

## **France**

- Zyxel France
- <https://www.zyxel.com/fr/fr>

## **Germany**

- Zyxel Deutschland GmbH.
- <https://www.zyxel.com/de/de>

## **Hungary**

- Zyxel Hungary & SEE
- <https://www.zyxel.com/hu/hu>

## **Italy**

- Zyxel Communications Italy S.r.l.
- <https://www.zyxel.com/it/it>

## **Norway**

- Zyxel Communications A/S
- <https://www.zyxel.com/no/no>

## **Poland**

- Zyxel Communications Poland
- <https://www.zyxel.com/pl/pl>

## **Romania**

- Zyxel Romania
- <https://www.zyxel.com/ro/ro>

## Russian Federation

- Zyxel Communications Corp.
- <https://www.zyxel.com/ru/ru>

## Slovakia

- Zyxel Slovakia
- <https://www.zyxel.com/sk/sk>

## Spain

- Zyxel Iberia
- <https://www.zyxel.com/es/es>

## Sweden

- Zyxel Communications A/S
- <https://www.zyxel.com/se/sv>

## Switzerland

- Studerus AG
- <https://www.zyxel.com/ch/de-ch>
- <https://www.zyxel.com/fr/fr>

## Turkey

- Zyxel Turkey A.S.
- <https://www.zyxel.com/tr/tr>

## UK

- Zyxel Communications UK Ltd.
- <https://www.zyxel.com/uk/en-gb>

## Ukraine

- Zyxel Ukraine
- <https://www.zyxel.com/ua/uk-ua>

## South America

### Argentina

- Zyxel Communications Corp.
- <https://www.zyxel.com/co/es-co>

### Brazil

- Zyxel Communications Brasil Ltda.

- <https://www.zyxel.com/br/pt>

## **Colombia**

- Zyxel Communications Corp.
- <https://www.zyxel.com/co/es-co>

## **Ecuador**

- Zyxel Communications Corp.
- <https://www.zyxel.com/co/es-co>

## **South America**

- Zyxel Communications Corp.
- <https://www.zyxel.com/co/es-co>

## **Middle East**

### **Israel**

- Zyxel Communications Corp.
- <https://il.zyxel.com>

## **North America**

### **USA**

- Zyxel Communications, Inc. – North America Headquarters
- <https://www.zyxel.com/us/en-us>

# APPENDIX B

## Wireless LANs

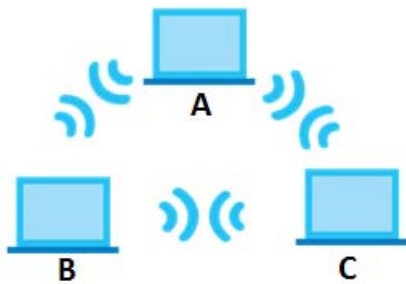
### Wireless LAN Topologies

This section discusses ad-hoc and infrastructure wireless LAN topologies.

### Ad-hoc Wireless LAN Configuration

The simplest WLAN configuration is an independent (Ad-hoc) WLAN that connects a set of computers with wireless adapters (A, B, C). Any time two or more wireless adapters are within range of each other, they can set up an independent network, which is commonly referred to as an ad-hoc network or Independent Basic Service Set (IBSS). The following diagram shows an example of notebook computers using wireless adapters to form an ad-hoc wireless LAN.

**Figure 290** Peer-to-Peer Communication in an Ad-hoc Network

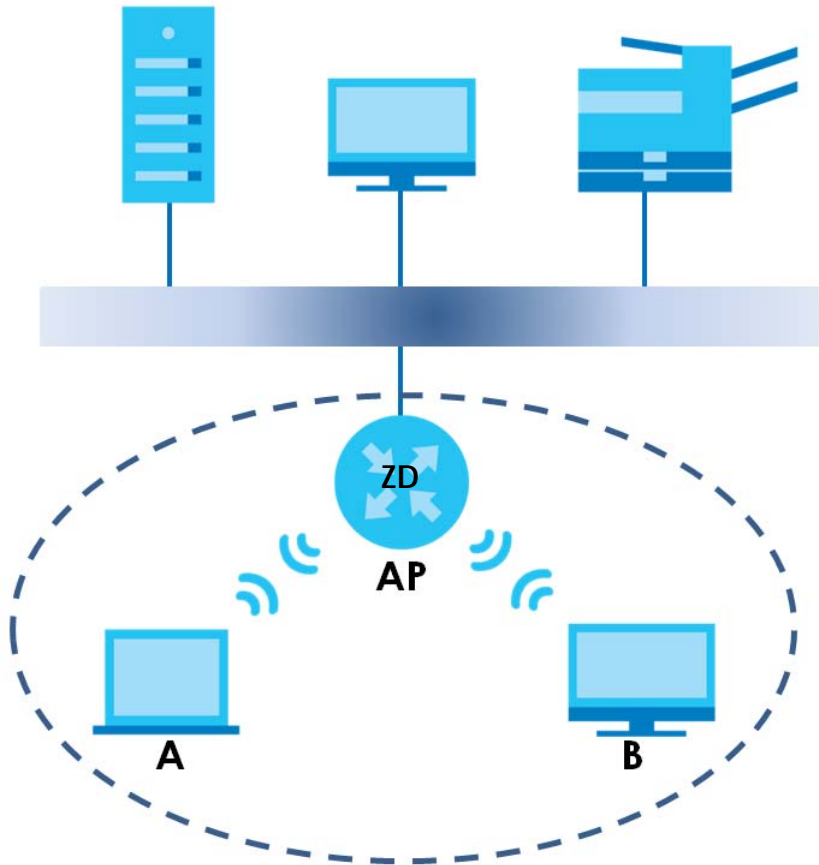


### BSS

A Basic Service Set (BSS) exists when all communications between WiFi clients or between a WiFi client and a wired network client go through one access point (AP).

Intra-BSS traffic is traffic between WiFi clients in the BSS. When Intra-BSS is enabled, WiFi client **A** and **B** can access the wired network and communicate with each other. When Intra-BSS is disabled, WiFi client **A** and **B** can still access the wired network but cannot communicate with each other.

Figure 291 Basic Service Set



## ESS

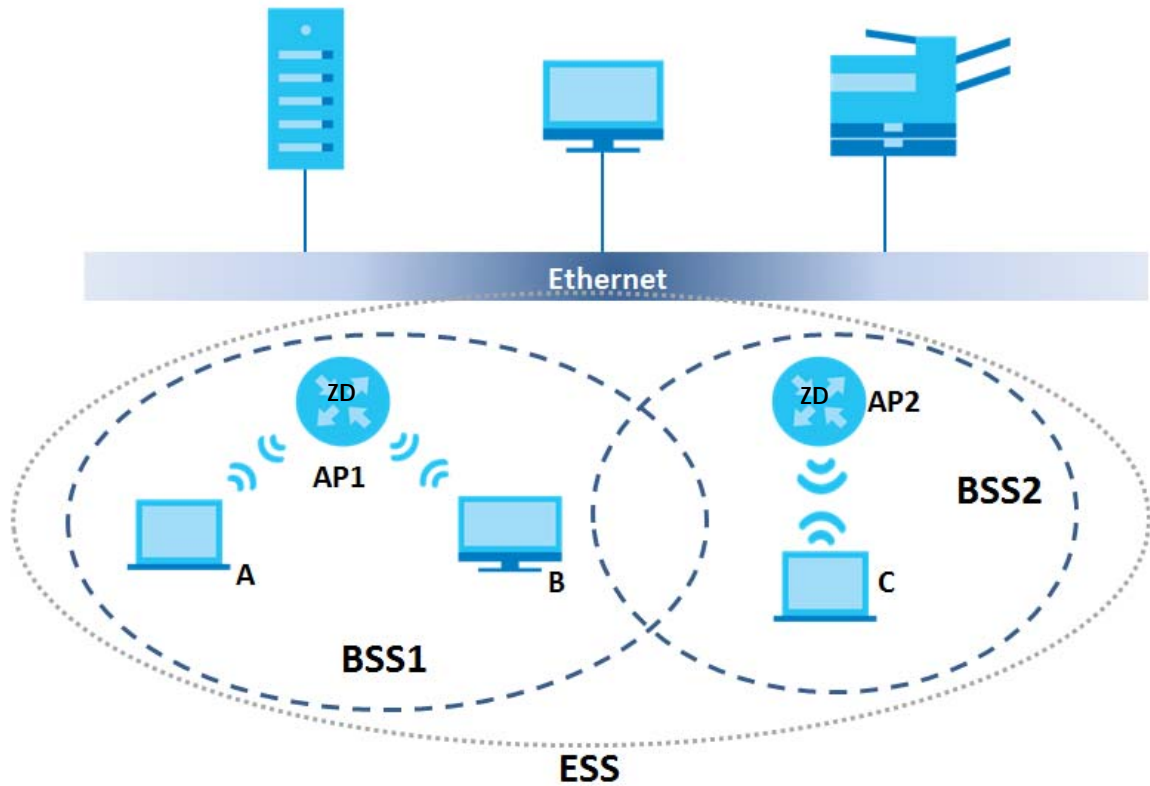
An Extended Service Set (ESS) consists of a series of overlapping BSSs, each containing an access point, with each access point connected together by a wired network. This wired connection between APs is called a Distribution System (DS).

This type of wireless LAN topology is called an Infrastructure WLAN. The Access Points not only provide communication with the wired network but also mediate wireless network traffic in the immediate neighborhood.

An ESSID (ESS IDentification) uniquely identifies each ESS. All access points and their associated WiFi clients within the same ESS must have the same ESSID in order to communicate.



Figure 292 Infrastructure WLAN



## Channel

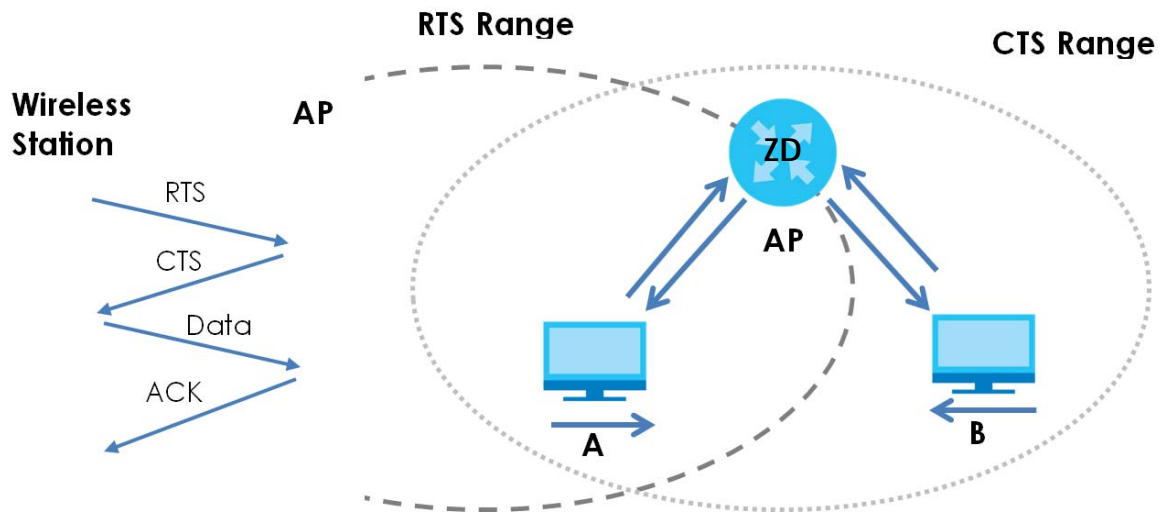
A channel is the radio frequency(ies) used by wireless devices to transmit and receive data. Channels available depend on your geographical area. You may have a choice of channels (for your region) so you should use a channel different from an adjacent AP (access point) to reduce interference. Interference occurs when radio signals from different access points overlap causing interference and degrading performance.

Adjacent channels partially overlap however. To avoid interference due to overlap, your AP should be on a channel at least five channels away from a channel that an adjacent AP is using. For example, if your region has 11 channels and an adjacent AP is using channel 1, then you need to select a channel between 6 or 11.

## RTS/CTS

A hidden node occurs when two stations are within range of the same access point, but are not within range of each other. The following figure illustrates a hidden node. Both stations (STA) are within range of the access point (AP) or wireless gateway, but out-of-range of each other, so they cannot "hear" each other, that is they do not know if the channel is currently being used. Therefore, they are considered hidden from each other.

Figure 293 RTS/CTS



When station **A** sends data to the AP, it might not know that the station **B** is already using the channel. If these two stations send data at the same time, collisions may occur when both sets of data arrive at the AP at the same time, resulting in a loss of messages for both stations.

**RTS/CTS** is designed to prevent collisions due to hidden nodes. An **RTS/CTS** defines the biggest size data frame you can send before an RTS (Request To Send)/CTS (Clear to Send) handshake is invoked.

When a data frame exceeds the **RTS/CTS** value you set (between 0 to 2432 bytes), the station that wants to transmit this frame must first send an RTS (Request To Send) message to the AP for permission to send it. The AP then responds with a CTS (Clear to Send) message to all other stations within its range to notify them to defer their transmission. It also reserves and confirms with the requesting station the time frame for the requested transmission.

Stations can send frames smaller than the specified **RTS/CTS** directly to the AP without the RTS (Request To Send)/CTS (Clear to Send) handshake.

You should only configure **RTS/CTS** if the possibility of hidden nodes exists on your network and the "cost" of resending large frames is more than the extra network overhead involved in the RTS (Request To Send)/CTS (Clear to Send) handshake.

If the **RTS/CTS** value is greater than the **Fragmentation Threshold** value (see next), then the RTS (Request To Send)/CTS (Clear to Send) handshake will never occur as data frames will be fragmented before they reach **RTS/CTS** size.

Note: Enabling the RTS Threshold causes redundant network overhead that could negatively affect the throughput performance instead of providing a remedy.

## Fragmentation Threshold

A **Fragmentation Threshold** is the maximum data fragment size (between 256 and 2432 bytes) that can be sent in the wireless network before the AP will fragment the packet into smaller data frames.

A large **Fragmentation Threshold** is recommended for networks not prone to interference while you should set a smaller threshold for busy networks or networks that are prone to interference.

If the **Fragmentation Threshold** value is smaller than the **RTS/CTS** value (see previously) you set then the RTS (Request To Send)/CTS (Clear to Send) handshake will never occur as data frames will be fragmented before they reach **RTS/CTS** size.

## IEEE 802.11g Wireless LAN

IEEE 802.11g is fully compatible with the IEEE 802.11b standard. This means an IEEE 802.11b adapter can interface directly with an IEEE 802.11g access point (and vice versa) at 11 Mbps or lower depending on range. IEEE 802.11g has several intermediate rate steps between the maximum and minimum data rates. The IEEE 802.11g data rate and modulation are as follows:

Table 196 IEEE 802.11g

DATA RATE (MBPS)	MODULATION
1	DBPSK (Differential Binary Phase Shift Keyed)
2	DQPSK (Differential Quadrature Phase Shift Keying)
5.5 / 11	CCK (Complementary Code Keying)
6/9/12/18/24/36/48/54	OFDM (Orthogonal Frequency Division Multiplexing)

## Wireless Security Overview

Wireless security is vital to your network to protect wireless communication between WiFi clients, access points and the wired network.

Wireless security methods available on the Zyxel Device are data encryption, WiFi client authentication, restricting access by device MAC address and hiding the Zyxel Device identity.

The following figure shows the relative effectiveness of these wireless security methods available on your Zyxel Device.

Table 197 Wireless Security Levels

SECURITY LEVEL	SECURITY TYPE
Least Secure	Unique SSID (Default)
	Unique SSID with Hide SSID Enabled
	MAC Address Filtering
	WEP Encryption
	IEEE802.1x EAP with RADIUS Server Authentication
Most Secure	WiFi Protected Access (WPA)
	WPA2

Note: You must enable the same wireless security settings on the Zyxel Device and on all WiFi clients that you want to associate with it.

## IEEE 802.1x

In June 2001, the IEEE 802.1x standard was designed to extend the features of IEEE 802.11 to support extended authentication as well as providing additional accounting and control features. It is supported by Windows XP and a number of network devices. Some advantages of IEEE 802.1x are:

- User based identification that allows for roaming.
- Support for RADIUS (Remote Authentication Dial In User Service, RFC 2138, 2139) for centralized user profile and accounting management on a network RADIUS server.
- Support for EAP (Extensible Authentication Protocol, RFC 2486) that allows additional authentication methods to be deployed with no changes to the access point or the WiFi clients.

## RADIUS

RADIUS is based on a client-server model that supports authentication, authorization and accounting. The access point is the client and the server is the RADIUS server. The RADIUS server handles the following tasks:

- Authentication  
Determines the identity of the users.
- Authorization  
Determines the network services available to authenticated users once they are connected to the network.
- Accounting  
Keeps track of the client's network activity.

RADIUS is a simple package exchange in which your AP acts as a message relay between the WiFi client and the network RADIUS server.

## Types of RADIUS Messages

The following types of RADIUS messages are exchanged between the access point and the RADIUS server for user authentication:

- Access-Request  
Sent by an access point requesting authentication.
- Access-Reject  
Sent by a RADIUS server rejecting access.
- Access-Accept  
Sent by a RADIUS server allowing access.
- Access-Challenge  
Sent by a RADIUS server requesting more information in order to allow access. The access point sends a proper response from the user and then sends another Access-Request message.

The following types of RADIUS messages are exchanged between the access point and the RADIUS server for user accounting:

- Accounting-Request  
Sent by the access point requesting accounting.
- Accounting-Response  
Sent by the RADIUS server to indicate that it has started or stopped accounting.

In order to ensure network security, the access point and the RADIUS server use a shared secret key, which is a password, they both know. The key is not sent over the network. In addition to the shared key, password information exchanged is also encrypted to protect the network from unauthorized access.

## Types of EAP Authentication

This section discusses some popular authentication types: EAP-MD5, EAP-TLS, EAP-TTLS, PEAP and LEAP. Your wireless LAN device may not support all authentication types.

EAP (Extensible Authentication Protocol) is an authentication protocol that runs on top of the IEEE 802.1x transport mechanism in order to support multiple types of user authentication. By using EAP to interact with an EAP-compatible RADIUS server, an access point helps a wireless station and a RADIUS server perform authentication.

The type of authentication you use depends on the RADIUS server and an intermediary AP(s) that supports IEEE 802.1x.

For EAP-TLS authentication type, you must first have a wired connection to the network and obtain the certificate(s) from a certificate authority (CA). A certificate (also called digital IDs) can be used to authenticate users and a CA issues certificates and guarantees the identity of each certificate owner.

## EAP-MD5 (Message-Digest Algorithm 5)

MD5 authentication is the simplest one-way authentication method. The authentication server sends a challenge to the WiFi client. The WiFi client 'proves' that it knows the password by encrypting the password with the challenge and sends back the information. Password is not sent in plain text.

However, MD5 authentication has some weaknesses. Since the authentication server needs to get the plaintext passwords, the passwords must be stored. Thus someone other than the authentication server may access the password file. In addition, it is possible to impersonate an authentication server as MD5 authentication method does not perform mutual authentication. Finally, MD5 authentication method does not support data encryption with dynamic session key. You must configure WEP encryption keys for data encryption.

## EAP-TLS (Transport Layer Security)

With EAP-TLS, digital certifications are needed by both the server and the WiFi clients for mutual authentication. The server presents a certificate to the client. After validating the identity of the server, the client sends a different certificate to the server. The exchange of certificates is done in the open before a secured tunnel is created. This makes user identity vulnerable to passive attacks. A digital certificate is an electronic ID card that authenticates the sender's identity. However, to implement EAP-TLS, you need a Certificate Authority (CA) to handle certificates, which imposes a management overhead.

## EAP-TTLS (Tunneled Transport Layer Service)

EAP-TTLS is an extension of the EAP-TLS authentication that uses certificates for only the server-side authentications to establish a secure connection. Client authentication is then done by sending username and password through the secure connection, thus client identity is protected. For client authentication, EAP-TTLS supports EAP methods and legacy authentication methods such as PAP, CHAP, MS-CHAP and MS-CHAP v2.

## PEAP (Protected EAP)

Like EAP-TLS, server-side certificate authentication is used to establish a secure connection, then use simple username and password methods through the secured connection to authenticate the clients, thus hiding client identity. However, PEAP only supports EAP methods, such as EAP-MD5, EAP-MSCHAPv2 and EAP-GTC (EAP-Generic Token Card), for client authentication. EAP-GTC is implemented only by Cisco.

## LEAP

LEAP (Lightweight Extensible Authentication Protocol) is a Cisco implementation of IEEE 802.1x.

## Dynamic WEP Key Exchange

The AP maps a unique key that is generated with the RADIUS server. This key expires when the wireless connection times out, disconnects or reauthentication times out. A new WEP key is generated each time reauthentication is performed.

If this feature is enabled, it is not necessary to configure a default encryption key in the wireless security configuration screen. You may still configure and store keys, but they will not be used while dynamic WEP is enabled.

Note: EAP-MD5 cannot be used with Dynamic WEP Key Exchange

For added security, certificate-based authentications (EAP-TLS, EAP-TTLS and PEAP) use dynamic keys for data encryption. They are often deployed in corporate environments, but for public deployment, a simple user name and password pair is more practical. The following table is a comparison of the features of authentication types.

Table 198 Comparison of EAP Authentication Types

	EAP-MD5	EAP-TLS	EAP-TTLS	PEAP	LEAP
Mutual Authentication	No	Yes	Yes	Yes	Yes
Certificate – Client	No	Yes	Optional	Optional	No
Certificate – Server	No	Yes	Yes	Yes	No
Dynamic Key Exchange	No	Yes	Yes	Yes	Yes
Credential Integrity	None	Strong	Strong	Strong	Moderate
Deployment Difficulty	Easy	Hard	Moderate	Moderate	Moderate
Client Identity Protection	No	No	Yes	Yes	No

## WPA and WPA2

WiFi Protected Access (WPA) is a subset of the IEEE 802.11i standard. WPA2 (IEEE 802.11i) is a wireless security standard that defines stronger encryption, authentication and key management than WPA.

Key differences between WPA or WPA2 and WEP are improved data encryption and user authentication.

If both an AP and the WiFi clients support WPA2 and you have an external RADIUS server, use WPA2 for stronger data encryption. If you don't have an external RADIUS server, you should use WPA2-PSK (WPA2-Pre-Shared Key) that only requires a single (identical) password entered into each access point, wireless

gateway and WiFi client. As long as the passwords match, a WiFi client will be granted access to a WLAN.

If the AP or the WiFi clients do not support WPA2, just use WPA or WPA-PSK depending on whether you have an external RADIUS server or not.

Select WEP only when the AP and/or WiFi clients do not support WPA or WPA2. WEP is less secure than WPA or WPA2.

## Encryption

WPA improves data encryption by using Temporal Key Integrity Protocol (TKIP), Message Integrity Check (MIC) and IEEE 802.1x. WPA2 also uses TKIP when required for compatibility reasons, but offers stronger encryption than TKIP with Advanced Encryption Standard (AES) in the Counter mode with Cipher block chaining Message authentication code Protocol (CCMP).

TKIP uses 128-bit keys that are dynamically generated and distributed by the authentication server. AES (Advanced Encryption Standard) is a block cipher that uses a 256-bit mathematical algorithm called Rijndael. They both include a per-packet key mixing function, a Message Integrity Check (MIC) named Michael, an extended initialization vector (IV) with sequencing rules, and a re-keying mechanism.

WPA and WPA2 regularly change and rotate the encryption keys so that the same encryption key is never used twice.

The RADIUS server distributes a Pairwise Master Key (PMK) key to the AP that then sets up a key hierarchy and management system, using the PMK to dynamically generate unique data encryption keys to encrypt every data packet that is wirelessly communicated between the AP and the WiFi clients. This all happens in the background automatically.

The Message Integrity Check (MIC) is designed to prevent an attacker from capturing data packets, altering them and resending them. The MIC provides a strong mathematical function in which the receiver and the transmitter each compute and then compare the MIC. If they do not match, it is assumed that the data has been tampered with and the packet is dropped.

By generating unique data encryption keys for every data packet and by creating an integrity checking mechanism (MIC), with TKIP and AES it is more difficult to decrypt data on a WiFi network than WEP and difficult for an intruder to break into the network.

The encryption mechanisms used for WPA(2) and WPA(2)-PSK are the same. The only difference between the two is that WPA(2)-PSK uses a simple common password, instead of user-specific credentials. The common-password approach makes WPA(2)-PSK susceptible to brute-force password-guessing attacks but it's still an improvement over WEP as it employs a consistent, single, alphanumeric password to derive a PMK which is used to generate unique temporal encryption keys. This prevent all wireless devices sharing the same encryption keys. (a weakness of WEP)

## User Authentication

WPA and WPA2 apply IEEE 802.1x and Extensible Authentication Protocol (EAP) to authenticate WiFi clients using an external RADIUS database. WPA2 reduces the number of key exchange messages from six to four (CCMP 4-way handshake) and shortens the time required to connect to a network. Other WPA2 authentication features that are different from WPA include key caching and pre-authentication. These two features are optional and may not be supported in all wireless devices.

Key caching allows a WiFi client to store the PMK it derived through a successful authentication with an AP. The WiFi client uses the PMK when it tries to connect to the same AP and does not need to go with the authentication process again.

Pre-authentication enables fast roaming by allowing the WiFi client (already connected to an AP) to perform IEEE 802.1x authentication with another AP before connecting to it.

## WiFi Client WPA Supplicants

A WiFi client supplicant is the software that runs on an operating system instructing the WiFi client how to use WPA. At the time of writing, the most widely available supplicant is the WPA patch for Windows XP, Funk Software's Odyssey client.

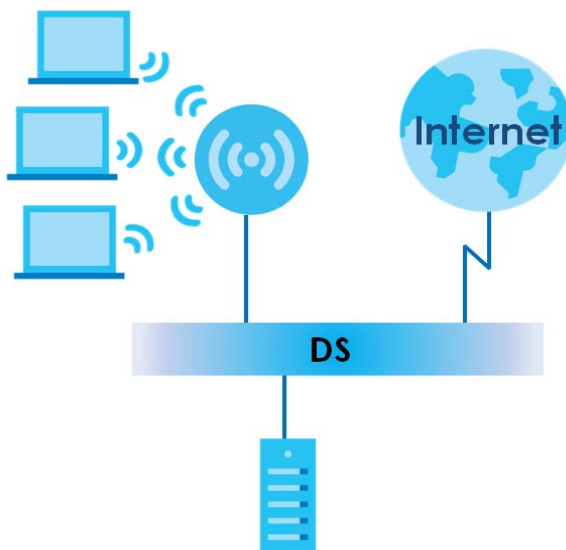
The Windows XP patch is a free download that adds WPA capability to Windows XP's built-in "Zero Configuration" WiFi client. However, you must run Windows XP to use it.

## WPA(2) with RADIUS Application Example

To set up WPA(2), you need the IP address of the RADIUS server, its port number (default is 1812), and the RADIUS shared secret. A WPA(2) application example with an external RADIUS server looks as follows. "A" is the RADIUS server. "DS" is the distribution system.

- 1 The AP passes the WiFi client's authentication request to the RADIUS server.
- 2 The RADIUS server then checks the user's identification against its database and grants or denies network access accordingly.
- 3 A 256-bit Pairwise Master Key (PMK) is derived from the authentication process by the RADIUS server and the client.
- 4 The RADIUS server distributes the PMK to the AP. The AP then sets up a key hierarchy and management system, using the PMK to dynamically generate unique data encryption keys. The keys are used to encrypt every data packet that is wirelessly communicated between the AP and the WiFi clients.

**Figure 294** WPA(2) with RADIUS Application Example



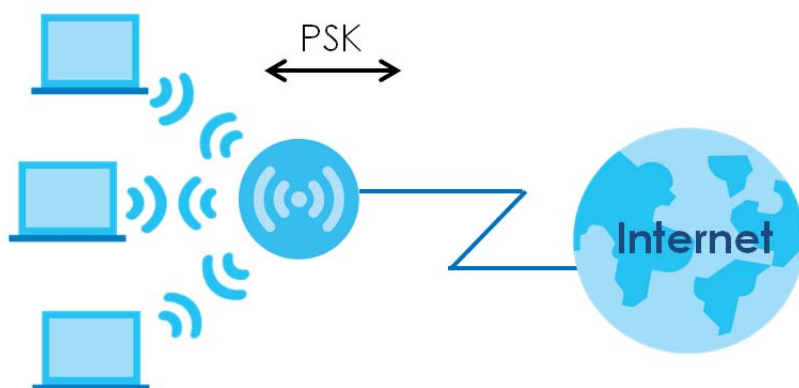


## WPA(2)-PSK Application Example

A WPA(2)-PSK application looks as follows.

- 1 First enter identical passwords into the AP and all WiFi clients. The Pre-Shared Key (PSK) must consist of between 8 to 63 alphanumeric (0-9, a-z, A-Z) and special characters, including spaces.
- 2 The AP checks each WiFi client's password and allows it to join the network only if the password matches.
- 3 The AP and WiFi clients generate a common PMK (Pairwise Master Key). The key itself is not sent over the network, but is derived from the PSK and the SSID.
- 4 The AP and WiFi clients use the TKIP or AES encryption process, the PMK and information exchanged in a handshake to create temporal encryption keys. They use these keys to encrypt data exchanged between them.

Figure 295 WPA(2)-PSK Authentication



## Security Parameters Summary

Refer to this table to see what other security parameters you should configure for each authentication method or key management protocol type. MAC address filters are not dependent on how you configure these security features.

Table 199 Wireless Security Relational Matrix

AUTHENTICATION METHOD/ KEY MANAGEMENT PROTOCOL	ENCRYPTION METHOD	ENTER MANUAL KEY	IEEE 802.1X
Open	None	No	Disable
			Enable without Dynamic WEP Key
Open	WEP	No	Enable with Dynamic WEP Key
		Yes	Enable without Dynamic WEP Key
		Yes	Disable
Shared	WEP	No	Enable with Dynamic WEP Key
		Yes	Enable without Dynamic WEP Key
		Yes	Disable

Table 199 Wireless Security Relational Matrix (continued)

AUTHENTICATION METHOD/ KEY MANAGEMENT PROTOCOL	ENCRYPTION METHOD	ENTER MANUAL KEY	IEEE 802.1X
WPA	TKIP/AES	No	Enable
WPA-PSK	TKIP/AES	Yes	Disable
WPA2	TKIP/AES	No	Enable
WPA2-PSK	TKIP/AES	Yes	Disable

## Antenna Overview

An antenna couples RF signals onto air. A transmitter within a wireless device sends an RF signal to the antenna, which propagates the signal through the air. The antenna also operates in reverse by capturing RF signals from the air.

Positioning the antennas properly increases the range and coverage area of a wireless LAN.

## Antenna Characteristics

### Frequency

An antenna in the frequency of 2.4 GHz (IEEE 802.11b and IEEE 802.11g) or 5 GHz (IEEE 802.11a) is needed to communicate efficiently in a wireless LAN

### Radiation Pattern

A radiation pattern is a diagram that allows you to visualize the shape of the antenna's coverage area.

### Antenna Gain

Antenna gain, measured in dB (decibel), is the increase in coverage within the RF beam width. Higher antenna gain improves the range of the signal for better communications.

For an indoor site, each 1 dB increase in antenna gain results in a range increase of approximately 2.5%. For an unobstructed outdoor site, each 1 dB increase in gain results in a range increase of approximately 5%. Actual results may vary depending on the network environment.

Antenna gain is sometimes specified in dBi, which is how much the antenna increases the signal power compared to using an isotropic antenna. An isotropic antenna is a theoretical perfect antenna that sends out radio signals equally well in all directions. dBi represents the true gain that the antenna provides.

## Types of Antennas for WiFi

There are two types of antennas used for WiFi applications.

- Omni-directional antennas send the RF signal out in all directions on a horizontal plane. The coverage area is torus-shaped (like a donut) which makes these antennas ideal for a room environment. With a wide coverage area, it is possible to make circular overlapping coverage areas with multiple access points.

- Directional antennas concentrate the RF signal in a beam, like a flashlight does with the light from its bulb. The angle of the beam determines the width of the coverage pattern. Angles typically range from 20 degrees (very directional) to 120 degrees (less directional). Directional antennas are ideal for hallways and outdoor point-to-point applications.

## Positioning Antennas

In general, antennas should be mounted as high as practically possible and free of obstructions. In point-to-point application, position both antennas at the same height and in a direct line of sight to each other to attain the best performance.

For omni-directional antennas mounted on a table, desk, and so on, point the antenna up. For omni-directional antennas mounted on a wall or ceiling, point the antenna down. For a single AP application, place omni-directional antennas as close to the center of the coverage area as possible.

For directional antennas, point the antenna in the direction of the desired coverage area.

# APPENDIX C

## IPv6

### Overview

IPv6 (Internet Protocol version 6), is designed to enhance IP address size and features. The increase in IPv6 address size to 128 bits (from the 32-bit IPv4 address) allows up to  $3.4 \times 10^{38}$  IP addresses.

### IPv6 Addressing

The 128-bit IPv6 address is written as eight 16-bit hexadecimal blocks separated by colons (:). This is an example IPv6 address `2001:0db8:1a2b:0015:0000:0000:1a2f:0000`.

IPv6 addresses can be abbreviated in two ways:

- Leading zeros in a block can be omitted. So `2001:0db8:1a2b:0015:0000:0000:1a2f:0000` can be written as `2001:db8:1a2b:15:0:0:1a2f:0`.
- Any number of consecutive blocks of zeros can be replaced by a double colon. A double colon can only appear once in an IPv6 address. So `2001:0db8:0000:0000:1a2f:0000:0000:0015` can be written as `2001:0db8::1a2f:0000:0000:0015`, `2001:0db8:0000:0000:1a2f::0015`, `2001:db8::1a2f:0:0:15` or `2001:db8:0:0:1a2f::15`.

### Prefix and Prefix Length

Similar to an IPv4 subnet mask, IPv6 uses an address prefix to represent the network address. An IPv6 prefix length specifies how many most significant bits (start from the left) in the address compose the network address. The prefix length is written as “/x” where x is a number. For example,

`2001:db8:1a2b:15::1a2f:0/32`

means that the first 32 bits (`2001:db8`) is the subnet prefix.

### Link-local Address

A link-local address uniquely identifies a device on the local network (the LAN). It is similar to a “private IP address” in IPv4. You can have the same link-local address on multiple interfaces on a device. A link-local unicast address has a predefined prefix of `fe80::/10`. The link-local unicast address format is as follows.

Table 200 Link-local Unicast Address Format

1111 1110 10	0	Interface ID
10 bits	54 bits	64 bits

### Global Address

A global address uniquely identifies a device on the Internet. It is similar to a “public IP address” in IPv4. A global unicast address starts with a 2 or 3.

## Unspecified Address

An unspecified address (0:0:0:0:0:0 or ::) is used as the source address when a device does not have its own address. It is similar to "0.0.0.0" in IPv4.

## Loopback Address

A loopback address (0:0:0:0:0:1 or ::1) allows a host to send packets to itself. It is similar to "127.0.0.1" in IPv4.

## Multicast Address

In IPv6, multicast addresses provide the same functionality as IPv4 broadcast addresses. Broadcasting is not supported in IPv6. A multicast address allows a host to send packets to all hosts in a multicast group.

Multicast scope allows you to determine the size of the multicast group. A multicast address has a predefined prefix of ff00::/8. The following table describes some of the predefined multicast addresses.

Table 201 Predefined Multicast Address

MULTICAST ADDRESS	DESCRIPTION
FF01:0:0:0:0:0:0:1	All hosts on a local node.
FF01:0:0:0:0:0:0:2	All routers on a local node.
FF02:0:0:0:0:0:0:1	All hosts on a local connected link.
FF02:0:0:0:0:0:0:2	All routers on a local connected link.
FF05:0:0:0:0:0:0:2	All routers on a local site.
FF05:0:0:0:0:0:1:3	All DHCP servers on a local site.

The following table describes the multicast addresses which are reserved and cannot be assigned to a multicast group.

Table 202 Reserved Multicast Address

MULTICAST ADDRESS
FF00:0:0:0:0:0:0:0
FF01:0:0:0:0:0:0:0
FF02:0:0:0:0:0:0:0
FF03:0:0:0:0:0:0:0
FF04:0:0:0:0:0:0:0
FF05:0:0:0:0:0:0:0
FF06:0:0:0:0:0:0:0
FF07:0:0:0:0:0:0:0
FF08:0:0:0:0:0:0:0
FF09:0:0:0:0:0:0:0
FF0A:0:0:0:0:0:0:0
FF0B:0:0:0:0:0:0:0
FF0C:0:0:0:0:0:0:0
FF0D:0:0:0:0:0:0:0
FF0E:0:0:0:0:0:0:0
FF0F:0:0:0:0:0:0:0

## Subnet Masking

Both an IPv6 address and IPv6 subnet mask compose of 128-bit binary digits, which are divided into eight 16-bit blocks and written in hexadecimal notation. Hexadecimal uses four bits for each character (1 – 10, A – F). Each block's 16 bits are then represented by four hexadecimal characters. For example, FFFF:FFFF:FFFF:FFFF:FC00:0000:0000:0000.

## Interface ID

In IPv6, an interface ID is a 64-bit identifier. It identifies a physical interface (for example, an Ethernet port) or a virtual interface (for example, the management IP address for a VLAN). One interface should have a unique interface ID.

## EUI-64

The EUI-64 (Extended Unique Identifier) defined by the IEEE (Institute of Electrical and Electronics Engineers) is an interface ID format designed to adapt with IPv6. It is derived from the 48-bit (6-byte) Ethernet MAC address as shown next. EUI-64 inserts the hex digits fffe between the third and fourth bytes of the MAC address and complements the seventh bit of the first byte of the MAC address. See the following example.

**Table 203**

MAC	00	: 13	: 49	: 12	: 34	: 56
-----	----	------	------	------	------	------

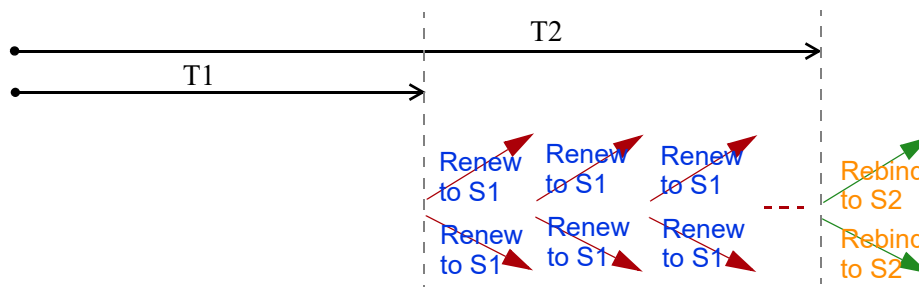
**Table 204**

EUI-64	02	: 13	: 49	: FF	: FE	: 12	: 34	: 56
--------	----	------	------	------	------	------	------	------

## Identity Association

An Identity Association (IA) is a collection of addresses assigned to a DHCP client, through which the server and client can manage a set of related IP addresses. Each IA must be associated with exactly one interface. The DHCP client uses the IA assigned to an interface to obtain configuration from a DHCP server for that interface. Each IA consists of a unique IAID and associated IP information.

The IA type is the type of address in the IA. Each IA holds one type of address. IA\_NA means an identity association for non-temporary addresses and IA\_TA is an identity association for temporary addresses. An IA\_NA option contains the T1 and T2 fields, but an IA\_TA option does not. The DHCPv6 server uses T1 and T2 to control the time at which the client contacts with the server to extend the lifetimes on any addresses in the IA\_NA before the lifetimes expire. After T1, the client sends the server (S1) (from which the addresses in the IA\_NA were obtained) a Renew message. If the time T2 is reached and the server does not respond, the client sends a Rebind message to any available server (S2). For an IA\_TA, the client may send a Renew or Rebind message at the client's discretion.



## DHCP Relay Agent

A DHCP relay agent is on the same network as the DHCP clients and helps forward messages between the DHCP server and clients. When a client cannot use its link-local address and a well-known multicast address to locate a DHCP server on its network, it then needs a DHCP relay agent to send a message to a DHCP server that is not attached to the same network.

The DHCP relay agent can add the remote identification (remote-ID) option and the interface-ID option to the Relay-Forward DHCPv6 messages. The remote-ID option carries a user-defined string, such as the system name. The interface-ID option provides slot number, port information and the VLAN ID to the DHCPv6 server. The remote-ID option (if any) is stripped from the Relay-Reply messages before the relay agent sends the packets to the clients. The DHCP server copies the interface-ID option from the Relay-Forward message into the Relay-Reply message and sends it to the relay agent. The interface-ID should not change even after the relay agent restarts.

## Prefix Delegation

Prefix delegation enables an IPv6 router to use the IPv6 prefix (network address) received from the ISP (or a connected uplink router) for its LAN. The Zyxel Device uses the received IPv6 prefix (for example, 2001:db2::/48) to generate its LAN IP address. Through sending Router Advertisements (RAs) regularly by multicast, the Zyxel Device passes the IPv6 prefix information to its LAN hosts. The hosts then can use the prefix to generate their IPv6 addresses.

## ICMPv6

Internet Control Message Protocol for IPv6 (ICMPv6 or ICMP for IPv6) is defined in RFC 4443. ICMPv6 has a preceding Next Header value of 58, which is different from the value used to identify ICMP for IPv4. ICMPv6 is an integral part of IPv6. IPv6 nodes use ICMPv6 to report errors encountered in packet processing and perform other diagnostic functions, such as "ping".

## Neighbor Discovery Protocol (NDP)

The Neighbor Discovery Protocol (NDP) is a protocol used to discover other IPv6 devices and track neighbor's reachability in a network. An IPv6 device uses the following ICMPv6 messages types:

- Neighbor solicitation: A request from a host to determine a neighbor's link-layer address (MAC address) and detect if the neighbor is still reachable. A neighbor being "reachable" means it responds to a neighbor solicitation message (from the host) with a neighbor advertisement message.
- Neighbor advertisement: A response from a node to announce its link-layer address.
- Router solicitation: A request from a host to locate a router that can act as the default router and forward packets.
- Router advertisement: A response to a router solicitation or a periodical multicast advertisement from a router to advertise its presence and other parameters.

## IPv6 Cache

An IPv6 host is required to have a neighbor cache, destination cache, prefix list and default router list. The Zyxel Device maintains and updates its IPv6 caches constantly using the information from response messages. In IPv6, the Zyxel Device configures a link-local address automatically, and then sends a neighbor solicitation message to check if the address is unique. If there is an address to be resolved or verified, the Zyxel Device also sends out a neighbor solicitation message. When the Zyxel Device

receives a neighbor advertisement in response, it stores the neighbor's link-layer address in the neighbor cache. When the Zyxel Device uses a router solicitation message to query for a router and receives a router advertisement message, it adds the router's information to the neighbor cache, prefix list and destination cache. The Zyxel Device creates an entry in the default router list cache if the router can be used as a default router.

When the Zyxel Device needs to send a packet, it first consults the destination cache to determine the next hop. If there is no matching entry in the destination cache, the Zyxel Device uses the prefix list to determine whether the destination address is on-link and can be reached directly without passing through a router. If the address is un-link, the address is considered as the next hop. Otherwise, the Zyxel Device determines the next-hop from the default router list or routing table. Once the next hop IP address is known, the Zyxel Device looks into the neighbor cache to get the link-layer address and sends the packet when the neighbor is reachable. If the Zyxel Device cannot find an entry in the neighbor cache or the state for the neighbor is not reachable, it starts the address resolution process. This helps reduce the number of IPv6 solicitation and advertisement messages.

## Multicast Listener Discovery

The Multicast Listener Discovery (MLD) protocol (defined in RFC 2710) is derived from IPv4's Internet Group Management Protocol version 2 (IGMPv2). MLD uses ICMPv6 message types, rather than IGMP message types. MLDv1 is equivalent to IGMPv2 and MLDv2 is equivalent to IGMPv3.

MLD allows an IPv6 switch or router to discover the presence of MLD listeners who wish to receive multicast packets and the IP addresses of multicast groups the hosts want to join on its network.

MLD snooping and MLD proxy are analogous to IGMP snooping and IGMP proxy in IPv4.

MLD filtering controls which multicast groups a port can join.

## MLD Messages

A multicast router or switch periodically sends general queries to MLD hosts to update the multicast forwarding table. When an MLD host wants to join a multicast group, it sends an MLD Report message for that address.

An MLD Done message is equivalent to an IGMP Leave message. When an MLD host wants to leave a multicast group, it can send a Done message to the router or switch. The router or switch then sends a group-specific query to the port on which the Done message is received to determine if other devices connected to this port should remain in the group.

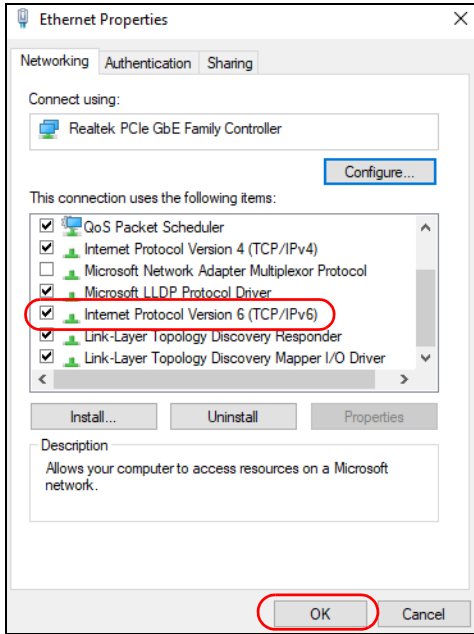
## Example – Enabling IPv6 on Windows 10


Windows 10 supports IPv6 by default. DHCPv6 is also enabled when you enable IPv6 on a Windows 10 computer.

To enable IPv6 in Windows 10:

- 1 Click the start icon, **Settings** and then **Network & Internet**.
- 2 Select the **Internet Protocol Version 6 (TCP/IPv6)** checkbox to enable it.
- 3 Click **OK** to save the change.





- 4 Click the Search icon (  ) and then enter "cmd" in the search box..
- 5 Use the `ipconfig` command to check your dynamic IPv6 address. This example shows a global address (2001:b021:2d::1000) obtained from a DHCP server.

```

C:\>ipconfig

Windows IP Configuration

Ethernet adapter Local Area Connection:

    Connection-specific DNS Suffix  . : 
    IPv6 Address. . . . . : 2001:b021:2d::1000
    Link-local IPv6 Address . . . . . : fe80::25d8:dcab:c80a:5189%11
    IPv4 Address. . . . . : 172.16.100.61
    Subnet Mask . . . . . : 255.255.255.0
    Default Gateway . . . . . : fe80::213:49ff:f
  
```

# APPENDIX D

## Services

The following table lists some commonly-used services and their associated protocols and port numbers.

- **Name:** This is a short, descriptive name for the service. You can use this one or create a different one, if you like.
- **Protocol:** This is the type of IP protocol used by the service. If this is **TCP/UDP**, then the service uses the same port number with TCP and UDP. If this is **USER-DEFINED**, the **Port(s)** is the IP protocol number, not the port number.
- **Port(s):** This value depends on the **Protocol**.
  - If the **Protocol** is **TCP**, **UDP**, or **TCP/UDP**, this is the IP port number.
  - If the **Protocol** is **USER**, this is the IP protocol number.
- **Description:** This is a brief explanation of the applications that use this service or the situations in which this service is used.

Table 205 Examples of Services

NAME	PROTOCOL	PORT(S)	DESCRIPTION
AH (IPSEC_TUNNEL)	User-Defined	51	The IPSEC AH (Authentication Header) tunneling protocol uses this service.
AIM	TCP	5190	AOL's Internet Messenger service.
AUTH	TCP	113	Authentication protocol used by some servers.
BGP	TCP	179	Border Gateway Protocol.
BOOTP_CLIENT	UDP	68	DHCP Client.
BOOTP_SERVER	UDP	67	DHCP Server.
CU-SEEME	TCP/UDP TCP/UDP	7648 24032	A popular videoconferencing solution from White Pines Software.
DNS	TCP/UDP	53	Domain Name Server, a service that matches web names (for instance <a href="http://www.zyxel.com">www.zyxel.com</a> ) to IP numbers.
ESP (IPSEC_TUNNEL)	User-Defined	50	The IPSEC ESP (Encapsulation Security Protocol) tunneling protocol uses this service.
FINGER	TCP	79	Finger is a UNIX or Internet related command that can be used to find out if a user is logged on.
FTP	TCP TCP	20 21	File Transfer Protocol, a program to enable fast transfer of files, including large files that may not be possible by email.
H.323	TCP	1720	NetMeeting uses this protocol.
HTTP	TCP	80	Hyper Text Transfer Protocol - a client/server protocol for the world wide web.
HTTPS	TCP	443	HTTPS is a secured http session often used in e-commerce.
ICMP	User-Defined	1	Internet Control Message Protocol is often used for diagnostic purposes.
ICQ	UDP	4000	This is a popular Internet chat program.
IGMP (MULTICAST)	User-Defined	2	Internet Group Multicast Protocol is used when sending packets to a specific group of hosts.
IKE	UDP	500	The Internet Key Exchange algorithm is used for key distribution and management.
IMAP4	TCP	143	The Internet Message Access Protocol is used for email.
IMAP4S	TCP	993	This is a more secure version of IMAP4 that runs over SSL.
IRC	TCP/UDP	6667	This is another popular Internet chat program.
MSN Messenger	TCP	1863	Microsoft Networks' messenger service uses this protocol.
NetBIOS	TCP/UDP TCP/UDP TCP/UDP TCP/UDP	137 138 139 445	The Network Basic Input/Output System is used for communication between computers in a LAN.
NEW-ICQ	TCP	5190	An Internet chat program.
NEWS	TCP	144	A protocol for news groups.

Table 205 Examples of Services (continued)

NAME	PROTOCOL	PORT(S)	DESCRIPTION
NFS	UDP	2049	Network File System - NFS is a client/server distributed file service that provides transparent file sharing for network environments.
NNTP	TCP	119	Network News Transport Protocol is the delivery mechanism for the USENET newsgroup service.
PING	User-Defined	1	Packet Internet Groper is a protocol that sends out ICMP echo requests to test whether or not a remote host is reachable.
POP3	TCP	110	Post Office Protocol version 3 lets a client computer get email from a POP3 server through a temporary connection (TCP/IP or other).
POP3S	TCP	995	This is a more secure version of POP3 that runs over SSL.
PPTP	TCP	1723	Point-to-Point Tunneling Protocol enables secure transfer of data over public networks. This is the control channel.
PPTP_TUNNEL (GRE)	User-Defined	47	PPTP (Point-to-Point Tunneling Protocol) enables secure transfer of data over public networks. This is the data channel.
RCMD	TCP	512	Remote Command Service.
REAL_AUDIO	TCP	7070	A streaming audio service that enables real time sound over the web.
REXEC	TCP	514	Remote Execution Daemon.
RLOGIN	TCP	513	Remote Login.
ROADRUNNER	TCP/UDP	1026	This is an ISP that provides services mainly for cable modems.
RTELNET	TCP	107	Remote Telnet.
RTSP	TCP/UDP	554	The Real Time Streaming (media control) Protocol (RTSP) is a remote control for multimedia on the Internet.
SFTP	TCP	115	The Simple File Transfer Protocol is an old way of transferring files between computers.
SMTP	TCP	25	Simple Mail Transfer Protocol is the message-exchange standard for the Internet. SMTP enables you to move messages from one email server to another.
SMTPS	TCP	465	This is a more secure version of SMTP that runs over SSL.
SNMP	TCP/UDP	161	Simple Network Management Program.
SNMP-TRAPS	TCP/UDP	162	Traps for use with the SNMP (RFC:1215).
SQL-NET	TCP	1521	Structured Query Language is an interface to access data on many different types of database systems, including mainframes, midrange systems, UNIX systems and network servers.
SSDP	UDP	1900	The Simple Service Discovery Protocol supports Universal Plug-and-Play (UPnP).
SSH	TCP/UDP	22	Secure Shell Remote Login Program.
STRM WORKS	UDP	1558	Stream Works Protocol.
SYSLOG	UDP	514	Syslog allows you to send system logs to a UNIX server.

Table 205 Examples of Services (continued)

<b>NAME</b>	<b>PROTOCOL</b>	<b>PORT(S)</b>	<b>DESCRIPTION</b>
TACACS	UDP	49	Login Host Protocol used for (Terminal Access Controller Access Control System).
TELNET	TCP	23	Telnet is the login and terminal emulation protocol common on the Internet and in UNIX environments. It operates over TCP/IP networks. Its primary function is to allow users to log into remote host systems.
VDOLIVE	TCP UDP	7000 user- defined	A videoconferencing solution. The UDP port number is specified in the application.

# APPENDIX E

## Legal Information

### Copyright

Copyright © 2023 by Zyxel and/or its affiliates.

The contents of this publication may not be reproduced in any part or as a whole, transcribed, stored in a retrieval system, translated into any language, or transmitted in any form or by any means, electronic, mechanical, magnetic, optical, chemical, photocopying, manual, or otherwise, without the prior written permission of Zyxel and/or its affiliates.

Published by Zyxel and/or its affiliates. All rights reserved.

### Disclaimer

Zyxel does not assume any liability arising out of the application or use of any products, or software described herein. Neither does it convey any license under its patent rights nor the patent rights of others. Zyxel further reserves the right to make changes in any products described herein without notice. This publication is subject to change without notice.

### EUROPEAN UNION and UNITED KINGDOM



The following information applies if you use the product within the European Union and United Kingdom.

#### Declaration of Conformity with Regard to EU Directive 2014/53/EU (Radio Equipment Directive, RED) and UK Radio Equipment Regulations 2017

Model List: AX7501-B0, AX7501-B1, DX3300-T0, DX3300-T1, DX3301-T0, DX5401-B0, DX5401-B1, EX3300-T0, EX3300-T1, EX3301-T0, EX3500-T0, EX3501-T0, EX5401-B0, EX5401-B1, EX5600-T1, EX5601-T0, EX5601-T1, EX7501-B0, PX3321-T1, PX5311-T0

- Compliance information for wireless products relevant to the EU, United Kingdom, and other Countries following the EU Directive 2014/53/EU (RED) and UK Radio Equipment Regulations 2017. And this product may be used in all EU countries (and other countries following the EU Directive 2014/53/EU) and United Kingdom without any limitation except for the countries mentioned below table:
- In the majority of the EU, United Kingdom, and other European countries, the 5 GHz bands have been made available for the use of wireless local area networks (LANs). Later in this document you will find an overview of countries in which additional restrictions or requirements or both are applicable. The requirements for any country may evolve. Zyxel recommends that you check with the local authorities for the latest status of their national regulations for the 5 GHz wireless LANs.
- If this device operates in the 5150 to 5350 MHz band, it is for indoor use only.
- This equipment should be installed and operated with a minimum distance of 20cm between the radio equipment and your body.
- The maximum RF operating power for each band is as follows:
  - DX3300-T0 / DX3301-T0 / EX3300-T0 / EX3301-T0
    - 95.28 mW for the 2,400 to 2,483.5 MHz band
    - 192.31 mW for the 5,150 to 5,350 MHz band
    - 912.01 mW for the 5,470 to 5,725 MHz band
  - AX7501-B0
    - 96.38 mW for the 2,400 to 2,483.5 MHz band
    - 184.50 mW for the 5,150 to 5,350 MHz band
    - 905.73 mW for the 5,470 to 5,725 MHz band
  - AX7501-B1
    - 90.16 mW for the 2,400 to 2,483.5 MHz band
    - 194.98 mW for the 5,150 to 5,350 MHz band
    - 993.12 mW for the 5,470 to 5,725 MHz band
  - DX5401-B0 and EX5401-B0
    - 8.57 mW for the 2,400 to 2,483.5 MHz band (Zigbee)
    - 97.72 mW for the 2,400 to 2,483.5 MHz band (Wi-Fi)
    - 177.42 mW for the 5,150 to 5,350 MHz band
    - 857.04 mW for the 5,470 to 5,725 MHz band
  - DX5401-B1 and EX5401-B1
    - 96.61 mW for the 2,400 to 2,483.5 MHz band
    - 193.64 mW for the 5,150 to 5,350 MHz band

- 698.23 mW for the 5,470 to 5,725 MHz band
- EX3500-T0 / EX3501-T0
  - 97.72 mW for the 2,400 to 2,483.5 MHz band
  - 191.43 mW for the 5,150 to 5,350 MHz band
  - 916.22 mW for the 5,470 to 5,725 MHz band
- EX5600-T1/EX5601-T0/EX5601-T1
  - 86.5 mW for the 2,400 to 2,483.5 MHz band
  - 176.6 mW for the 5,150 to 5,350 MHz band
  - 870.1 mW for the 5,470 to 5,725MHz band
  - 170.61 mW for the 5,725 to 5,850 MHz band
- EX7501-B0
  - 88.51 mW for the 2,400 to 2,483.5 MHz band
  - 179.47 mW for the 5,150 to 5,350 MHz band
  - 883.08 mW for the 5,470 to 5,725 MHz band
  - 23dBm for the 5.725 to 5.850 MHz band
- DX3300-T1 and EX3300-T1
  - 97.5 mW for the 2,400 to 2,483.5 MHz band
  - 194.09 mW for the 5,150 to 5,350 MHz band
  - 922.57 mW for the 5,470 – 5,725 MHz band
- PX3321-T1
  - 99.77 mW for the 2,400 to 2,483.5 MHz band
  - 199.07 mW for the 5,150 to 5,350 MHz band
  - 997.7 mW for the 5,470 to 5,725 MHz band
- PX5531-T0
  - 99.77 mW for the 2,400 to 2,483.5 MHz band
  - 199.07 mW for the 5,150 to 5,350 MHz band
  - 997.7 mW for the 5,470 to 5,725 MHz band

Български (Bulgarian)	С настоящото Zyxel декларира, че това оборудване е в съответствие със съществените изисквания и другите приложими разпоредбите на Директива 2014/53/ЕС.  <b>National Restrictions</b> <ul style="list-style-type: none"> <li>• The Belgian Institute for Postal Services and Telecommunications (BIPT) must be notified of any outdoor wireless link having a range exceeding 300 meters. Please check <a href="http://www.bipt.be">http://www.bipt.be</a> for more details.</li> <li>• Draadloze verbindingen voor buitengebruik en met een reikwijdte van meer dan 300 meter dienen aangemeld te worden bij het Belgisch Instituut voor postdiensten en telecommunicatie (BIPT). Zie <a href="http://www.bipt.be">http://www.bipt.be</a> voor meer gegevens.</li> <li>• Les liaisons sans fil pour une utilisation en extérieur d'une distance supérieure à 300 mètres doivent être notifiées à l'Institut Belge des services Postaux et des Télécommunications (IBPT). Visitez <a href="http://www.ibpt.be">http://www.ibpt.be</a> pour de plus amples détails.</li> </ul>
Español (Spanish)	Por medio de la presente Zyxel declara que el equipo cumple con los requisitos esenciales y cualesquiera otras disposiciones aplicables o exigibles de la Directiva 2014/53/UE.
Čeština (Czech)	Zyxel tímto prohlašuje, že tento zařízení je ve shodě se základními požadavky a dalšími příslušnými ustanoveními směrnice 2014/53/EU.
Dansk (Danish)	Undertegnede Zyxel erklærer herved, at følgende udstyr overholder de væsentlige krav og øvrige relevante krav i direktiv 2014/53/EU.
Deutsch (German)	Hiermit erklärt Zyxel, dass sich das Gerät Ausstattung in Übereinstimmung mit den grundlegenden Anforderungen und den übrigen einschlägigen Bestimmungen der Richtlinie 2014/53/EU befindet.
Eesti keel (Estonian)	Käesolevaga kinnitab Zyxel seadme seadmed vastavust direktiivi 2014/53/EL põhinõuetele ja nimetatud direktiivist tulenevatele teistele asjakohastele sätetele.
Ελληνικά (Greek)	ΜΕ ΤΗΝ ΠΑΡΟΥΣΑ Ζyxel ΔΗΛΩΝΕΙ ΟΤΙ ΕΞΟΠΛΙΣΜΟΣ ΣΥΜΜΟΡΦΩΝΕΤΑΙ ΠΡΟΣ ΤΙΣ ΟΥΣΙΩΔΕΙΣ ΑΠΑΙΤΗΣΕΙΣ ΚΑΙ ΤΙΣ ΛΟΙΠΕΣ ΣΧΕΤΙΚΕΣ ΔΙΑΤΑΞΕΙΣ ΤΗΣ ΟΔΗΓΙΑΣ 2014/53/ΕΕ.
English	Hereby, Zyxel declares that this device is in compliance with the essential requirements and other relevant provisions of Directive 2014/53/EU.
Français (French)	Par la présente Zyxel déclare que l'appareil équipements est conforme aux exigences essentielles et aux autres dispositions pertinentes de la directive 2014/53/UE.
Hrvatski (Croatian)	Zyxel ovime izjavljuje da je radijska oprema tipa u skladu s Direktivom 2014/53/UE.
Íslenska (Icelandic)	Hér með lýsir, Zyxel því yfir að þessi búnaður er í samræmi við grunnkröfur og önnur viðeigandi ákvæði tilskipunar 2014/53/UE.

Italiano (Italian)	<p>Con la presente Zyxel dichiara che questo attrezzatura è conforme ai requisiti essenziali ed alle altre disposizioni pertinenti stabilite dalla direttiva 2014/53/UE.</p> <p><b>National Restrictions</b></p> <ul style="list-style-type: none"> <li>This product meets the National Radio Interface and the requirements specified in the National Frequency Allocation Table for Italy. Unless this wireless LAN product is operating within the boundaries of the owner's property, its use requires a "general authorization." Please check <a href="https://www.mise.gov.it/">https://www.mise.gov.it/</a> for more details.</li> <li>Questo prodotto è conforme alla specifiche di Interfaccia Radio Nazionali e rispetta il Piano Nazionale di ripartizione delle frequenze in Italia. Se non viene installato all'interno del proprio fondo, l'utilizzo di prodotti Wireless LAN richiede una "Autorizzazione Generale". Consultare <a href="https://www.mise.gov.it/">https://www.mise.gov.it/</a> per maggiori dettagli.</li> </ul>
Latviešu valoda (Latvian)	Ar šo Zyxel deklarē, ka iekārtas atbilst Direktīvas 2014/53/ES būtiskajām prasībām un citiem ar to saistītajiem noteikumiem.
Lietuvių kalba (Lithuanian)	Šiuo Zyxel deklaruoja, kad šis įranga atitinka esminius reikalavimus ir kitas 2014/53/ES Direktyvos nuostatas.
Magyar (Hungarian)	Alulírott, Zyxel nyilatkozom, hogy a berendezés megfelel a vonatkozó alapvető követelményeknek és az 2014/53/EU irányelv egyéb előírásainak.
Malti (Maltese)	Hawnhekk, Zyxel, jiddikjara li dan tagħmir jikkonforma mal-ftiġġiet essenzjali u ma provvedimenti oħrajn rilevanti li hemm fid-Direttiva 2014/53/UE.
Nederlands (Dutch)	Hierbij verklaart Zyxel dat het toestel uitrusting in overeenstemming is met de essentiële eisen en de andere relevante bepalingen van richtlijn 2014/53/EU.
Polski (Polish)	Niniejszym Zyxel oświadcza, że sprzęt jest zgodny z zasadniczymi wymogami oraz pozostałymi stosownymi postanowieniami Dyrektywy 2014/53/UE.
Português (Portuguese)	Zyxel declara que este equipamento está conforme com os requisitos essenciais e outras disposições da Directiva 2014/53/UE.
Română (Romanian)	Prin prezenta, Zyxel declară că acest echipament este în conformitate cu cerințele esențiale și alte prevederi relevante ale Directivei 2014/53/UE.
Slovenčina (Slovak)	Zyxel týmto vyhlasuje, že zariadenia spĺňa základné požiadavky a všetky príslušné ustanovenia Smernice 2014/53/EÚ.
Slovenščina (Slovene)	Zyxel izjavlja, da je ta oprema v skladu z bistvenimi zahtevami in ostalimi relevantnimi določili direktive 2014/53/EU.
Suomi (Finnish)	Zyxel vakuuttaa täten että laitteet tyyppinen laite on direktiivin 2014/53/EU oleellisten vaatimusten ja sitä koskevien direktiivin muiden ehtojen mukainen.
Svenska (Swedish)	Härmed intygar Zyxel att denna utrustning står i överensstämmelse med de väsentliga egenskapskrav och övriga relevanta bestämmelser som framgår av direktiv 2014/53/EU.
Norsk (Norwegian)	Erklærer herved Zyxel at dette utstyret er i samsvar med de grunnleggende kravene og andre relevante bestemmelser i direktiv 2014/53/EU.

**Notes:**

- Although Norway, Switzerland and Liechtenstein are not EU member states, the EU Directive 2014/53/EU has also been implemented in those countries.
- The regulatory limits for maximum output power are specified in EIRP. The EIRP level (in dBm) of a device can be calculated by adding the gain of the antenna used (specified in dBi) to the output power available at the connector (specified in dBm).



## List of national codes

COUNTRY	ISO 3166 2 LETTER CODE	COUNTRY	ISO 3166 2 LETTER CODE
Austria	AT	Liechtenstein	LI
Belgium	BE	Lithuania	LT
Bulgaria	BG	Luxembourg	LU
Croatia	HR	Malta	MT
Cyprus	CY	Netherlands	NL
Czech Republic	CZ	Norway	NO
Denmark	DK	Poland	PL
Estonia	EE	Portugal	PT
Finland	FI	Romania	RO
France	FR	Serbia	RS
Germany	DE	Slovakia	SK
Greece	GR	Slovenia	SI
Hungary	HU	Spain	ES
Iceland	IS	Switzerland	CH
Ireland	IE	Sweden	SE
Italy	IT	Turkey	TR
Latvia	LV	United Kingdom	GB

## Safety Warnings

- Do not put the device in a place that is humid, dusty, has extreme temperatures, or that blocks the device ventilation slots. These conditions may harm your device.
- Please refer to the device back label, datasheet, box specifications or catalog information for power rating of the device and operating temperature.
- There is a remote risk of electric shock from lightning: (1) Do not use the device outside, and make sure all the connections are indoors. (2) Do not install or service this device during a thunderstorm.
- Do not expose your device to dampness, dust or corrosive liquids.
- Do not store things on the device.
- Do not obstruct the device ventilation slots as insufficient airflow may harm your device. For example, do not place the device in an enclosed space such as a box or on a very soft surface such as a bed or sofa.
- Do not install or service this device during a thunderstorm. There is a remote risk of electric shock from lightning.
- Connect ONLY suitable accessories to the device.
- Do not open the Zyxel Device. Opening or removing the device covers can expose you to dangerous high voltage points or other risks.
- Only qualified service personnel should service or disassemble this device. Please contact your vendor for further information.
- Make sure to connect the cables to the correct ports.
- Place connected cables carefully so that no one will step on them or stumble over them.
- Disconnect all cables from this device before servicing or disassembling.
- Do not remove the plug and connect it to a power outlet by itself; always attach the plug to the power adaptor first before connecting it to a power outlet.
- Do not allow anything to rest on the power adaptor or cord and do NOT place the product where anyone can walk on the power adaptor or cord.
- Please use the provided or designated connection cables/power cables/adaptors. Connect the power adaptor or cord to the right supply voltage (for example, 120V AC in North America or 230V AC in Europe). If the power adaptor or cord is damaged, it might cause electrocution. Remove the damaged power adaptor or cord from the device and the power source. Contact your local vendor to order a new one.
- CAUTION: There is a risk of explosion if you replace the device battery with an incorrect one. Dispose of used batteries according to the instructions. Dispose them at the applicable collection point for the recycling of electrical and electronic devices. For detailed information about recycling of this product, please contact your local city office, your household waste disposal service or the store where you purchased the product.
- Do not leave a battery in an extremely high temperature environment or surroundings since it can result in an explosion or the leakage of flammable liquid or gas.
- Do not subject a battery to extremely low air pressure since it may result in an explosion or the leakage of flammable liquid or gas.
- The following warning statements apply, where the disconnect device is not incorporated in the device or where the plug on the power supply cord is intended to serve as the disconnect device.
  - For a permanently connected device, a readily accessible method to disconnect the device shall be incorporated externally to the device;
  - For a pluggable device, the socket-outlet shall be installed near the device and shall be easily accessible.
- This product is intended to be supplied by a DC power source marked 'L.P.S' or 'Limited Power Source', rated 12.0 Vdc, 1.5A and Tma 40 °C (min.).

The following information applies for products with SFP:

- CLASS 1 LASER PRODUCT & "IEC 60825-1:2014"
- CLASS 1 CONSUMER LASER PRODUCT & "EN 50689:2021"
- Caution – Use of controls or adjustments or performance of procedures other than those specified herein may result in hazardous radiation exposure.
- Complies with 21 CFR 1040.10 and 1040.11 except for conformance with IEC 60825-1 Ed. 3., as described in Laser Notice No. 56, dated May 8, 2019.

## Important Safety Instructions

- Caution! The RJ-45 jacks are not used for telephone line connection.
- Caution! Do not use this product near water, for example a wet basement or near a swimming pool.
- Caution! Avoid using this product (other than a cordless type) during an electrical storm. There may be a remote risk of electric shock from lightning.
- Caution! Always disconnect all telephone lines from the wall outlet before servicing or disassembling this product.
- Attention: Les prises RJ-45 ne sont pas utilisés pour la connexion de la ligne téléphonique.
- Attention: Ne pas utiliser ce produit près de l'eau, par exemple un sous-sol humide ou près d'une piscine.
- Attention: Évitez d'utiliser ce produit (autre qu'un type sans fil) pendant un orage. Il peut y avoir un risque de choc électrique de la foudre.
- Attention: Toujours débrancher toutes les lignes téléphoniques de la prise murale avant de réparer ou de démonter ce produit.

## Environment Statement

### ErP (Energy-related Products)

Zyxel products put on the EU and United Kingdom market in compliance with the requirement of the European Parliament and the Council published Directive 2009/125/EC and UK regulation establishing a framework for the setting of ecodesign requirements for energy-related products (recast), so called as "ErP Directive (Energy-related Products directive)" as well as ecodesign requirement laid down in applicable implementing measures, power consumption has satisfied regulation requirements which are:

- Network standby power consumption < 8W (watts), and/or
- Off mode power consumption < 0.5W (watts), and/or
- Standby mode power consumption < 0.5W (watts).

(Wireless setting, please refer to the chapter about wireless settings for more detail.)

### Disposal and Recycling Information

The symbol below means that according to local regulations your product and/or its battery shall be disposed of separately from domestic waste. If this product is end of life, take it to a recycling station designated by local authorities. At the time of disposal, the separate collection of your product and/or its battery will help save natural resources and ensure that the environment is sustainable development.

Die folgende Symbol bedeutet, dass Ihr Produkt und/oder seine Batterie gemäß den örtlichen Bestimmungen getrennt vom Hausmüll entsorgt werden muss. Wenden Sie sich an eine Recyclingstation, wenn dieses Produkt das Ende seiner Lebensdauer erreicht hat. Zum Zeitpunkt der Entsorgung wird die getrennte Sammlung von Produkt und/oder seiner Batterie dazu beitragen, natürliche Ressourcen zu sparen und die Umwelt und die menschliche Gesundheit zu schützen.

El símbolo de abajo indica que según las regulaciones locales, su producto y/o su batería deberán depositarse como basura separada de la doméstica. Cuando este producto alcance el final de su vida útil, llévelo a un punto limpio. Cuando llegue el momento de desechar el producto, la recogida por separado éste y/o su batería ayudará a salvar los recursos naturales y a proteger la salud humana y medioambiental.

Le symbole ci-dessous signifie que selon les réglementations locales votre produit et/ou sa batterie doivent être éliminés séparément des ordures ménagères. Lorsque ce produit atteint sa fin de vie, amenez-le à un centre de recyclage. Au moment de la mise au rebut, la collecte séparée de votre produit et/ou de sa batterie aidera à économiser les ressources naturelles et protéger l'environnement et la santé humaine.

Il simbolo sotto significa che secondo i regolamenti locali il vostro prodotto e/o batteria deve essere smaltito separatamente dai rifiuti domestici. Quando questo prodotto raggiunge la fine della vita di servizio portarlo a una stazione di riciclaggio. Al momento dello smaltimento, la raccolta separata del vostro prodotto e/o della sua batteria aiuta a risparmiare risorse naturali e a proteggere l'ambiente e la salute umana.

Symbolen innebär att enligt lokal lagstiftning ska produkten och/eller dess batteri kastas separat från hushållsavfallet. När den här produkten når slutet av sin livslängd ska du ta den till en återvinningsstation. Vid tiden för kasseringen bidrar du till en bättre miljö och mänsklig hälsa genom att göra dig av med den på ett återvinningsställe.



台灣



以下訊息僅適用於產品具有無線功能且銷售至台灣地區

- 取得審驗證明之低功率射頻器材，非經核准，公司、商號或使用者均不得擅自變更頻率、加大功率或變更原設計之特性及功能。
- 低功率射頻器材之使用不得影響飛航安全及干擾合法通信；經發現有干擾現象時，應立即停用，並改善至無干擾時方得繼續使用。前述合法通信，指依電信管理法規定作業之無線電通信。低功率射頻器材須忍受合法通信或工業、科學及醫療用電波輻射性電機設備之干擾。

- 本機限在不干擾合法電台與不被干擾保障條件下於室內使用。本產品使用時建議應距離人體 20 cm 以上。
- 無線資訊傳輸設備忍受合法通信之干擾且不得干擾合法通信；如造成干擾，應立即停用，俟無干擾之虞，始得繼續使用。
- 無線資訊傳輸設備的製造廠商應確保頻率穩定性，如依製造廠商使用手冊上所述正常操作，發射的信號應維持於操作頻帶中。
- 使用無線產品時，應避免影響附近雷達系統之操作。
- 高增益指向性天線只得應用於固定式點對點系統。

以下訊息僅適用於產品屬於專業安裝並銷售至台灣地區

- 本器材須經專業工程人員安裝及設定，始得設置使用，且不得直接販售給一般消費者。





安全警告 - 為了您的安全，請先閱讀以下警告及指示：

- 請勿將此產品接近水、火焰或放置在高溫的環境。
- 避免設備接觸：
  - 任何液體 - 切勿讓設備接觸水、雨水、高濕度、污水腐蝕性的液體或其他水份。
  - 灰塵及污物 - 切勿接觸灰塵、污物、沙土、食物或其他不合適的材料。
- 雷雨天氣時，不要安裝或維修此設備。有遭受電擊的風險。
- 切勿重摔或撞擊設備，並勿使用不正確的電源變壓器。
- 若接上不正確的電源變壓器會有爆炸的風險。
- 請勿隨意更換產品內的電池。
- 如果更換不正確之電池型式，會有爆炸的風險，請依製造商說明書處理使用過之電池。
- 請將廢電池丟棄在適當的電器或電子設備回收處。
- 請勿將設備解體。
- 請勿阻礙設備的散熱孔，空氣對流不足將會造成設備損害。
- 請使用隨貨提供或指定的連接線 / 電源線 / 電源變壓器，將其連接到合適的供應電壓（如：台灣供應電壓 110 伏特）。
- 假若電源變壓器或電源變壓器的纜線損壞，請從插座拔除，若您繼續插電使用，會有觸電死亡的風險。
- 請勿試圖修理電源變壓器或電源變壓器的纜線，若有毀損，請直接聯絡您購買的店家，購買一個新的電源變壓器。
- 請勿將此設備安裝於室外，此設備僅適合放置於室內。
- 請勿隨一般垃圾丟棄。
- 請參閱產品背貼上的設備額定功率。
- 請參考產品型錄或是彩盒上的作業溫度。
- 產品沒有斷電裝置或者採用電源線的插頭視為斷電裝置的一部分，以下警語將適用：
  - 對永久連接之設備，在設備外部須安裝可觸及之斷電裝置；
  - 對插接式之設備，插座必須接近安裝之地點而且是易於觸及的。

## About the Symbols

Various symbols are used in this product to ensure correct usage, to prevent danger to the user and others, and to prevent property damage. The meaning of these symbols are described below. It is important that you read these descriptions thoroughly and fully understand the contents.

### Explanation of the Symbols

SYMBOL	EXPLANATION
	Alternating current (AC): AC is an electric current in which the flow of electric charge periodically reverses direction.
	Direct current (DC): DC is the unidirectional flow or movement of electric charge carriers.
	Earth; ground: A wiring terminal intended for connection of a Protective Earthing Conductor.
	Class II equipment: The method of protection against electric shock in the case of class II equipment is either double insulation or reinforced insulation.

## Viewing Certifications

Go to <http://www.zyxel.com> to view this product's documentation and certifications.

## Zyxel Limited Warranty

Zyxel warrants to the original end user (purchaser) that this product is free from any defects in material or workmanship for a specific period (the Warranty Period) from the date of purchase. The Warranty Period varies by region. Check with your vendor and/or the authorized Zyxel local distributor for details about the Warranty Period of this product. During the warranty period, and upon proof of purchase, should the product

have indications of failure due to faulty workmanship and/or materials, Zyxel will, at its discretion, repair or replace the defective products or components without charge for either parts or labor, and to whatever extent it shall deem necessary to restore the product or components to proper operating condition. Any replacement will consist of a new or re-manufactured functionally equivalent product of equal or higher value, and will be solely at the discretion of Zyxel. This warranty shall not apply if the product has been modified, misused, tampered with, damaged by an act of God, or subjected to abnormal working conditions.

### Note

Repair or replacement, as provided under this warranty, is the exclusive remedy of the purchaser. This warranty is in lieu of all other warranties, express or implied, including any implied warranty of merchantability or fitness for a particular use or purpose. Zyxel shall in no event be held liable for indirect or consequential damages of any kind to the purchaser.

To obtain the services of this warranty, contact your vendor.

### Registration

Register your product online at [www.zyxel.com](http://www.zyxel.com) to receive e-mail notices of firmware upgrades and related information.

### Open Source Licenses

This product may contain in part some free software distributed under GPL license terms and/or GPL-like licenses.

To request the source code covered under these licenses, please go to: <https://service-provider.zyxel.com/global/en/gpl-oss-software-notice>.

## Numbers

2.5G WiFi LED [30](#)

5G WiFi LED [31](#)

6rd

IPv6 [202](#)

## A

access

troubleshooting [506](#)

Access Control (Rules) screen [378](#)

ACK message [434](#)

activation

firewalls [376](#)

media server [373](#)

SSID [245](#)

Address Resolution Protocol [453](#)

antenna

directional [531](#)

gain [530](#)

omni-directional [530](#)

Any\_WAN

Remote Management [473](#)

AP (access point) [521](#)

Application Layer Gateway (ALG) [339](#)

applications

media server [372](#)

activation [373](#)

iTunes server [372](#)

applications, NAT [348](#)

ARP Table [453, 455](#)

Asynchronous Transfer Mode [201](#)

ATM [201](#)

authentication [261](#)

## B

backup

configuration [493](#)

backup configuration [493](#)

Backup/Restore screen [492](#)

bandwidth capacity

cable type [25](#)

Basic Service Set, See BSS [519](#)

Basic Service Set, see BSS

blinking LEDs [29](#)

bottom panel

buttons [54, 55, 57, 61, 62](#)

Bridge mode [210, 220](#)

broadband [199](#)

Broadband screen

overview [199](#)

broadcast [236](#)

BSS [263, 519](#)

example [264](#)

button

power [50, 54, 55, 57](#)

reset [50, 54, 55, 57](#)

WLAN [50, 54, 55, 57, 59, 60](#)

WPS [50](#)

BYE request [434](#)

## C

CA [408, 525](#)

cable type

Ethernet [25](#)

call hold [439, 441](#)

call service mode [439, 440](#)

call transfer [440, 441](#)

call waiting [440, 441](#)

Canonical Format Indicator See CFI

CCMs [497](#)

certificate

---

- details [410](#)
- factory default [402](#)
- file format [409](#)
- file path [407](#)
- import [402](#), [406](#)
- public and private keys [408](#)
- verification [409](#)
- Certificate Authority
  - See CA.
- certificate request
  - create [402](#)
  - view [404](#)
- certificates [401](#)
  - advantages [409](#)
  - authentication [401](#)
  - CA [401](#), [408](#)
  - creating [403](#)
  - public key [401](#)
  - replacing [402](#)
  - storage space [402](#)
  - thumbprint algorithms [409](#)
  - trusted CAs [406](#)
  - verifying fingerprints [409](#)
- Certification Authority [401](#)
- Certification Authority, see CA
- certifications [545](#)
  - viewing [547](#)
- CFI [235](#)
- CFM [497](#)
  - CCMs [497](#)
  - link trace test [497](#)
  - loopback test [497](#)
  - MA [497](#)
  - MD [497](#)
  - MEG [500](#)
  - MEP [497](#)
  - MIP [497](#)
- channel [521](#)
  - interference [521](#)
- Class of Service [437](#)
- Class of Service, see CoS
- client list [279](#)
- client-server protocol [431](#)
- comfort noise generation [436](#)
- configuration
  - backup [493](#)
  - firewalls [376](#)
  - restoring [494](#)
  - static route [352](#)
- connection status screen [66](#)
- Connectivity Check Messages, see CCMs
- contact information [514](#)
- copyright [542](#)
- CoS [327](#), [437](#)
- CoS technologies [310](#)
- Create Certificate Request screen [403](#)
- creating certificates [403](#)
- CTS (Clear to Send) [522](#)
- CTS threshold [254](#), [261](#)
- customer support [514](#)
- customized service [377](#)
  - add [378](#)
- customized services [378](#)

## D

- data fragment threshold [254](#), [261](#)
- DDoS [375](#)
- Denials of Service, see DoS
- DHCP [272](#), [289](#)
- DHCP Server Lease Time [276](#)
- DHCP Server State [276](#)
- diagnostic [497](#)
- diagnostic screens [497](#)
- differentiated services [438](#)
- Differentiated Services, see DiffServ [327](#)
- DiffServ [327](#)
  - marking rule [327](#)
- DiffServ (Differentiated Services) [437](#)
  - code points [437](#)
  - marking rule [438](#)
- digital IDs [401](#)
- disclaimer [542](#)
- distance maximum
  - cable type [25](#)
- DLNA [372](#)
- DMZ screen [338](#)
- DNS [272](#), [289](#)
- DNS server address assignment [236](#)
- DNS Values [276](#)

---

---

Domain Name [349](#)  
domain name system, see DNS  
DoS [375](#)  
    thresholds [375](#)  
DoS protection blocking  
    enable [382](#)  
DS field [327, 438](#)  
DS, see differentiated services  
DSCP [327, 437](#)  
DSL  
    counters [461](#)  
    port details [461](#)  
    statistics [460](#)  
Dual Stack Lite [202](#)  
dual/tri-radios [23](#)  
dual-band application [23](#)  
dual-band gateway [23](#)  
dual-radio application [23](#)  
dynamic DNS [350](#)  
    wildcard [351](#)  
Dynamic Host Configuration Protocol, see DHCP  
dynamic WEP key exchange [526](#)  
DYNDNS wildcard [351](#)

## E

EAP Authentication [525](#)  
ECHO [349](#)  
echo cancellation [436](#)  
email  
    log example [488](#)  
    log setting [487](#)  
Encapsulation [232](#)  
    MER [232](#)  
    PPP over Ethernet [233](#)  
encapsulation  
    RFC 1483 [233](#)  
encapsulation method  
    technical reference [232](#)  
encryption [527](#)  
ESS [520](#)  
Ether Type [318](#)  
Ethernet port [50, 54, 55, 57](#)  
Europe type call service mode [439](#)

Extended Service Set Identification [242, 247](#)  
Extended Service Set, See ESS [520](#)

## F

factory defaults  
    reset [494](#)  
factory-default configuration  
    reload [64](#)  
Fast Leave [357](#)  
fiber cable  
    connecting [63](#)  
    removal [63](#)  
FIBER port [50](#)  
file sharing [26](#)  
filters  
    MAC address [249, 262](#)  
Finger services [349](#)  
firewall  
    enhancing security [383](#)  
    LAND attack [375](#)  
    security considerations [384](#)  
    traffic rule direction [381](#)  
Firewall DoS screen [381](#)  
Firewall General screen [376](#)  
firewall rules  
    direction of travel [382](#)  
firewalls [374, 376](#)  
    actions [381](#)  
    configuration [376](#)  
    customized service [377](#)  
    customized services [378](#)  
    DDoS [375](#)  
    DoS [375](#)  
        thresholds [375](#)  
    ICMP [375](#)  
    Ping of Death [375](#)  
    rules [382](#)  
    security [383](#)  
    SYN attack [374](#)  
firmware [489](#)  
Firmware Upgrade screen [489](#)  
firmware upload [489](#)  
firmware version  
    check [490](#)

flash key [439](#)  
flashing [439](#)  
fragmentation threshold [254](#), [261](#), [522](#)  
FTP [27](#), [332](#), [349](#)  
    unusable [508](#)

## G

G.168 [436](#)  
General wireless LAN screen [239](#)  
Guide  
    Quick Start [2](#)

## H

hidden node [521](#)  
Home Security URL filtering [388](#)  
HTTP [349](#)

## I

IBSS [519](#)  
ICMP [375](#)  
ICMPv6 [355](#)  
IEEE 802.11ax [239](#)  
IEEE 802.11g [523](#)  
IEEE 802.1Q [235](#)  
IGA [346](#)  
IGMP [236](#)  
    multicast group list [355](#), [458](#), [459](#)  
    version [236](#)  
IGMP Fast Leave [355](#)  
IGMPv2 [355](#)  
IGMPv3 [355](#)  
ILA [346](#)  
Import Certificate screen [406](#)  
importing trusted CAs [406](#)  
Independent Basic Service Set  
    See IBSS [519](#)  
initialization vector (IV) [527](#)  
Inside Global Address, see IGA

Inside Local Address, see ILA  
interface group [361](#)  
Internet  
    no access [509](#)  
    wizard setup [77](#)  
Internet access  
    wizard setup [77](#)  
Internet access application  
    Ethernet WAN [22](#)  
Internet Blocking [186](#)  
Internet connection  
    add or edit [204](#), [214](#)  
    slow or erratic [510](#)  
Internet Control Message Protocol, see ICMP  
INTERNET LED [30](#)  
Internet Protocol version 6 [201](#)  
Internet Protocol version 6, see IPv6  
Intra LAN Multicast [357](#)  
IP address [290](#)  
    private [290](#)  
    WAN [200](#)  
IP address assignment [235](#)  
IP alias  
    NAT applications [348](#)  
IP over Ethernet [232](#)  
IP packet  
    transmission method [236](#)  
IPoE technical reference [232](#)  
IPv4 firewall [377](#)  
IPv6 [201](#), [532](#)  
    addressing [201](#), [236](#), [532](#)  
    EUI-64 [534](#)  
    global address [532](#)  
    interface ID [534](#)  
    link-local address [532](#)  
    Neighbor Discovery Protocol [532](#)  
    ping [532](#)  
    prefix [201](#), [237](#), [532](#)  
    prefix and length [201](#)  
    prefix delegation [203](#)  
    prefix length [201](#), [237](#), [532](#)  
    subnet mask [201](#)  
    unspecified address [533](#)  
IPv6 address  
    abbreviation method [236](#)  
IPv6 firewall [377](#)



---

IPv6 rapid deployment [202](#)  
iTunes server [372](#)  
ITU-T [436](#)

## K

key combinations [442](#)  
keypad [442](#)

## L

LAN [271](#)  
    client list [279](#)  
    DHCP [289](#)  
    DNS [289](#)  
    IP address [290](#)  
    MAC address [280](#)  
    status [190, 195](#)  
    subnet mask [273, 290](#)  
LAN IP address [276](#)  
LAN IPv6 Mode Setup [277](#)  
LAN Setup screen [273](#)  
LAN subnet mask [276](#)  
LAN to LAN multicast [357](#)  
LAND attack [375](#)  
LBR [497](#)  
LED  
    2.4G WiFi [30](#)  
    5G WiFi [31](#)  
    INTERNET [30](#)  
    POWER [29](#)  
    WPS [31](#)  
LED description [29, 36, 38, 40, 44, 45](#)  
LED indicators [29](#)  
limitations  
    wireless LAN [263](#)  
    WPS [270](#)  
link trace [497](#)  
Link Trace Message, see LTM  
Link Trace Response, see LTR  
listening port [422](#)  
Local Area Network, see LAN  
Local Certificates screen [401](#)

Log Setting screen [485](#)  
login [65](#)  
    password [65](#)  
Login screen  
    no access [506](#)  
logs [443, 446, 458, 465, 485](#)  
Loop Back Response, see LBR  
loopback [497](#)  
LTM [497](#)  
LTR [497](#)

## M

MA [497](#)  
MAC address [250, 280](#)  
    filter [249, 262](#)  
    LAN [280](#)  
MAC Authentication screen [249](#)  
MAC Filter [385](#)  
Maintenance Association, see MA  
Maintenance Domain, see MD  
Maintenance End Point, see MEP  
Management Information Base (MIB) [476](#)  
managing the device  
    good habits [27](#)  
Maximum Burst Size (MBS) [234](#)  
MBSSID [264](#)  
MD [497](#)  
media server [372](#)  
    activation [373](#)  
    iTunes server [372](#)  
MEP [497](#)  
MESH  
    enable [258](#)  
MGMT Services screen [472](#)  
MLD [355](#)  
MLDv1 [355](#)  
MLDv2 [355](#)  
MTU (Multi-Tenant Unit) [235](#)  
Multi\_WAN  
    Remote Management [473](#)  
multicast [236](#)  
Multicast Listener Discovery, see MLD

---

multi-gigabit [24](#)  
multimedia [430](#)  
Multiple BSS, see MBSSID  
multiplexing [233](#)  
    LLC-based [233](#)  
    VC-based [233](#)  
multiprotocol encapsulation [233](#)

## N

NAT [346, 347](#)  
    applications [348](#)  
        IP alias [348](#)  
    default server [338](#)  
    DMZ host [338](#)  
    example [348](#)  
    global [347](#)  
    IGA [346](#)  
    ILA [346](#)  
    inside [347](#)  
    local [347](#)  
    multiple server example [332](#)  
    outside [347](#)  
    port number [349](#)  
    services [349](#)  
NAT ALG screen [339, 340, 343](#)  
NAT example [349](#)  
Network Address Translation, see NAT  
network disconnect  
    temporary [491](#)  
network map [186](#)  
NNTP [349](#)  
Nslookup test [498](#)

## O

OK response [434, 435](#)  
Others screen [254](#)

## P

Packet Transfer Mode [201](#)

Pairwise Master Key (PMK) [527, 529](#)  
parental control  
    schedule setup [391, 393](#)  
password [65](#)  
    admin [506](#)  
    lost [506](#)  
    user [506](#)  
PBC [265](#)  
Peak Cell Rate (PCR) [233](#)  
Per-Hop Behavior, see PHB [327](#)  
PHB [327, 438](#)  
phone functions [442](#)  
PHONE port [50, 54, 57](#)  
PIN, WPS [265](#)  
    example [267](#)  
Ping of Death [375](#)  
Ping test [498](#)  
Ping/TraceRoute/Nslookup screen [498](#)  
Point-to-Point Tunneling Protocol, see PPTP  
POP3 [349](#)  
port  
    LAN [50, 54, 55, 57](#)  
    PHONE1/2 [50, 54, 57](#)  
    USB [50, 54, 55, 57](#)  
    WAN [54, 55, 57, 59](#)  
port forwarding rule  
    add/edit [333](#)  
Port Forwarding screen [333](#)  
Port Triggering  
    add new rule [337](#)  
Port Triggering screen [335](#)  
ports [29](#)  
ports panel  
    buttons [50](#)  
POWER button [50, 54, 55, 57, 59, 60](#)  
POWER LED [29, 36, 38, 40, 44, 45, 47, 49](#)  
PPPoE [233](#)  
    Benefits [233](#)  
    technical reference [233](#)  
PPTP [349](#)  
preamble [255, 261](#)  
preamble mode [264](#)  
prefix delegation [203](#)  
private IP address [290](#)  
problems [505](#)

---

Protocol (Customized Services) screen [377](#)  
Protocol Entry  
  add [378](#)  
PSK [527](#)  
PTM [201](#)  
Push Button Configuration, see PBC  
push button, WPS [265](#)

## Q

QoS [309](#), [327](#), [437](#)  
  marking [310](#)  
  setup [309](#)  
  tagging [310](#)  
  versus CoS [310](#)  
Quality of Service, see QoS  
Quick Start Guide [2](#)

## R

RADIUS [524](#)  
  message types [524](#)  
  messages [524](#)  
  shared secret key [525](#)  
Real time Transport Protocol, see RTP  
Reboot screen [496](#)  
reset [64](#)  
RESET button [50](#), [54](#), [55](#), [57](#), [59](#), [60](#), [61](#), [62](#)  
  using [64](#)  
reset to factory defaults [494](#)  
restart system [496](#)  
restoring configuration [494](#)  
RFC 1058, see RIP  
RFC 1389, see RIP  
RFC 1483 [233](#)  
RFC 1631 [331](#)  
RFC 1889 [433](#)  
RFC 3164 [443](#)  
RIP [308](#)  
Routing Information Protocol, see RIP  
RTP [433](#)  
RTS (Request To Send) [522](#)

---

threshold [521](#), [522](#)  
RTS threshold [254](#), [261](#)

## S

security  
  network [383](#)  
  wireless LAN [261](#)

Security Log [445](#)

Security Parameter Index, see SPI

service access control [474](#)

Service Set [242](#), [247](#)

services  
  port forwarding [349](#)

Session Initiation Protocol, see SIP

setup  
  firewalls [376](#)  
  static route [352](#)

SFP+ transceiver [50](#)

silence suppression [436](#)

Simple Network Management Protocol, see SNMP

Single Rate Three Color Marker, see srTCM

SIP [430](#)  
  account [430](#)  
  call progression [433](#)  
  client [431](#)  
  identities [430](#)  
  INVITE request [434](#), [435](#)  
  number [430](#)  
  OK response [435](#)  
  proxy server [431](#)  
  redirect server [432](#)  
  register server [433](#)  
  servers [431](#)  
  service domain [430](#)  
  URI [430](#)  
  user agent [431](#)

SMTP [349](#)

SNMP [349](#), [476](#)  
  agents [476](#)  
  Get [477](#)  
  GetNext [477](#)  
  Manager [476](#)  
  managers [476](#)  
  MIB [476](#)  
  network components [476](#)

---

- Set [477](#)
- Trap [477](#)
- versions [476](#)
- SNMP trap [349](#)
- SPI [375](#)
- srTCM [329](#)
- SSH
  - unusable [508](#)
- SSID [262](#)
  - activation [245](#)
  - MBSSID [264](#)
- static DHCP [279](#)
  - configuration [280](#)
- Static DHCP screen [279](#)
- static route [299, 308](#)
  - configuration [352](#)
- status [186](#)
  - LAN [190, 195](#)
  - WAN [190](#)
  - wireless LAN [190](#)
- status indicators [29](#)
- subnet mask [290](#)
- supplementary services [438](#)
- Sustained Cell Rate (SCR) [234](#)
- SYN attack [374](#)
- syslog
  - protocol [443](#)
  - severity levels [443](#)
- syslog logging
  - enable [487](#)
- syslog server
  - name or IP address [487](#)
- system
  - firmware [489](#)
  - password [65](#)
  - reset [64](#)
  - status [186](#)
    - LAN [190, 195](#)
    - WAN [190](#)
    - wireless LAN [190](#)
  - time [479](#)

## T

Telnet

---

- unusable [508](#)
- three-way conference [440, 441](#)
- thresholds
  - data fragment [254, 261](#)
  - DoS [375](#)
  - RTS/CTS [254, 261](#)
- time [479](#)
- ToS [437](#)
- TPID [235](#)
- Trace Route test [498](#)
- traffic shaping [233](#)
- transmission speed
  - cable type [25](#)
- troubleshooting [505](#)
- trTCM [330](#)
- Trust Domain
  - add [474](#)
- Trust Domain screen [473](#)
- Trusted CA certificate
  - view [407](#)
- Trusted CA screen [405](#)
- Two Rate Three Color Marker, see trTCM
- TWT (Target Wakeup Time) [239](#)
- Type of Service, see ToS

## U

- unicast [236](#)
- Uniform Resource Identifier [430](#)
- Universal Plug and Play, see UPnP
- upgrading firmware [489](#)
- UPnP [281](#)
  - forum [273](#)
  - NAT traversal [272](#)
  - security issues [273](#)
  - state [282](#)
  - usage confirmation [272](#)
- UPnP screen [281](#)
- UPnP-enabled Network Device
  - auto-discover [293](#)
- USA type call service mode [440](#)
- USB feature
  - Media Server [27](#)
- USB features [26](#)

---

Cellular Backup [26](#)  
USB port [50](#), [54](#), [55](#), [57](#)

## V

VAD [436](#)  
Vendor ID [284](#)  
Virtual Circuit (VC) [233](#)  
Virtual Local Area Network See VLAN  
VLAN [235](#)  
    Introduction [235](#)  
VLAN ID [235](#)  
VLAN tag [235](#)  
voice activity detection [436](#)  
voice coding [435](#)  
VoIP [430](#)

## W

Wake on LAN [285](#)  
WAN  
    status [190](#)  
    Wide Area Network, see WAN [199](#)  
WAN IP address [200](#)  
warranty [547](#)  
    note [548](#)  
Web Configurator  
    login [65](#)  
    password [65](#)  
WEP [243](#)  
WEP Encryption [244](#)  
WiFi  
    MBSSID [264](#)  
Wi-Fi Protected Access [526](#)  
WiFi standards  
    comparison table [239](#)  
WiFi6 introduction [239](#)  
wireless client WPA supplicants [528](#)  
Wireless General screen [240](#)  
wireless LAN [238](#)  
    authentication [261](#)  
    BSS [263](#)

---

- example [264](#)
- example [259](#)
- fragmentation threshold [254, 261](#)
- limitations [263](#)
- MAC address filter [249, 262](#)
- preamble [255, 261](#)
- RTS/CTS threshold [254, 261](#)
- security [261](#)
- SSID [262](#)
  - activation [245](#)
- status [190](#)
- WPS [265, 267](#)
  - example [268](#)
  - limitations [270](#)
  - PIN [265](#)
  - push button [265](#)
- wireless security [523](#)
- Wireless tutorial [92](#)
- wizard setup
  - Internet [77](#)
- WLAN
  - interference [521](#)
  - security parameters [529](#)
- WLAN button [50](#)
- WMM screen [252](#)
- WPA [243, 526](#)
  - key caching [528](#)
  - pre-authentication [528](#)
  - user authentication [527](#)
  - vs WPA-PSK [527](#)
  - wireless client supplicant [528](#)
  - with RADIUS application example [528](#)
- WPA2 [243, 526](#)
  - user authentication [527](#)
  - vs WPA2-PSK [527](#)
  - wireless client supplicant [528](#)
  - with RADIUS application example [528](#)
- WPA2-Pre-Shared Key [526](#)
- WPA2-PSK [243, 526, 527](#)
  - application example [529](#)
- WPA3-SAE (Simultaneous Authentication of Equals handshake) [243](#)
- WPA-PSK [527](#)
  - application example [529](#)
- WPA-PSK (WiFi Protected Access-Pre-Shared Key) [243](#)
- WPS [265, 267](#)
  - activate [64](#)
  - example [268](#)
  - limitations [270](#)



---

PIN [265](#)  
    example [267](#)  
    push button [265](#)  
WPS button [50, 54, 55, 57, 59, 60](#)  
    using [64](#)  
WPS LED [31](#)  
WPS screen [250](#)  
WWAN package version  
    check [490](#)

## **Z**

Zyxel Device  
    managing [27](#)